















Table of Contents

	Page #		Page #
1.0 Introduction	3	6.0 Decoder Programming and Configuration (continued)	
2.0 Features and Specifications	4-5	6.9 Digitrax Configuration Register	26
3.0 <b>Quick Installation Guide</b>	6-8	6.10 Programming Other Manufacturer's Decoders	26
4.0 <b>CT4</b> Memory Throttle Control Panel	9	7.0 Operational Considerations	27
4.1  Run/Stop	10	7.1 Mixed DCC & Conventional Operation	27
4.2  Group	10-11	7.2 BC-2 Cable/Multiple Boosters	27-28
4.3  Adv/Std	11	7.3 Intelligent Auto-reverse Operation	29
4.4  Light	11-12	8.0 Troubleshooting	29
4.5  Arrow/Select	12	8.1 Clean Track	29
4.6-4.9  Throttles Red, Green, Blue, Black	12	8.2 Reprogram the Decoder	29
5.0 <b>DB 100a</b> Control Panel	13	8.3 Emergency Stop	30
5.1 Power Input	13-15	8.4 Mechanical Drive Train Problems	30
5.2 Power On Indicator	15	8.5 "Strange Lights"	30
5.3 Ground	15	8.6 FCC information	30
5.4 Rail A Rail B	15-18	9.0 Warranty and Repair Information	31
5.5  Track Status	18		
5.6  Over Temperature	18-19		
5.7 Sync/Booster Setup	19		
5.71 Challenger Setup	19		
5.72 Standard Booster Setup	19		
5.73 Auto-reversing Booster Setup	19		
5.8 <b>LOCONET™</b> Ports A & B	20		
5.9  Mode Switch	21		
5.10  Scale Voltage Switch	22		
6.0 Decoder Programming and Configuration	23		
6.1 Locomotive Address	23		
6.2 Programming Track	23		
6.3 How to Program Decoders	24-26		
6.4  V-Start	24		
6.5  Acceleration	25		
6.6  Deceleration(Braking)	25		
6.7  V-Mid	25		
6.8 MU Operations	26		

Digitrax, Challenger, Intelligent Auto-reversing, and LocoNet are trademarks of Digitrax, Inc. All rights reserved.

## 1.0 Introduction:

Congratulations on your purchase of a Digitrax ~~CHALLENGER~~<sup>TM</sup> Digital Command Control System!

The overall design of the Digitrax Command Control system allows you to create a working layout very quickly by connecting various system components in the configuration that best meets your needs. The Digitrax system drastically reduces and simplifies layout wiring and, you probably won't need to rewire your existing system.

We put a great deal of engineering effort into generating powerful and electrically "clean" track drive signals to give you reliable decoder operation with minimal radio and TV interference. All Digitrax boosters comply with FCC Part 15, Class B RFI requirements.

Your success with and enjoyment of our products are very important to us. After all, this is a hobby and it is FUN!!! Please read this manual carefully before you install your **DB 100a**. We have included lots of hints and operating ideas based on our experience with the Digitrax system. If you have questions not covered by this manual please contact your dealer.



NOTE: Decoder installation instructions are covered in a separate Decoder Test and Installation Manual. Plans for building CTX/CTY throttles are also provided separately.

## 2.0 ~~CHALLENGER~~ **DB 100a** Features and Specifications:

- The **DB 100a** becomes a multi-featured ~~CHALLENGER~~ Digital Command Control Station when used with the Digitrax **CT4** Handheld Memory Throttle or your own personally customized CTX or CTY Hand Throttle (Plans for constructing the CTX/CTY are available from Digitrax.).

This is the most cost-effective and powerful feature of the **DB 100a**. It can control up to 15 locomotives equipped with DCC compatible digital decoders and one conventional DC locomotive at the same time, on the same track. It includes a built in programmer that allows access to the Advanced Features available in Digitrax Decoders.









- 4.5 Amp Multi-scale (switch selectable) Digital Command Control booster, capable of running N, HO or O/S/G scale (and anything in between) when fed from a UL rated Safety Extra Low Voltage power supply.
- "Intelligent Auto-reverse"<sup>TM</sup> operation is selectable only when **DB 100a** is operating as a booster. This allows you to drive trains through reversing loops without any switching or short circuit problems. This innovation uses smart internal logic to execute an "on the fly" polarity reversal within two-thousandths of a second to clear most short-circuit faults that happen when conductive wheels bridge the isolating gaps. This is truly prototypical operation, and best of all, the function is integrated **inside the booster** and not in a maze of external switches and relays.
- Compatible with the proposed NMRA DCC standard.
- Accepts either 50/60Hz AC or DC input from your existing power pack or from any transformer that is within the specified ratings. The power pack should be overload protected for a maximum output of 4.5 amps DC. Minimum input voltage is 12V AC or 12V DC. Maximum input voltage is 22V AC and 28V DC.











- Over voltage protected and stabilized track drive output, up to the selected scale voltage.
- Auto-resetting over temperature protection protects against excessive heat generation in the booster when large track currents, high input voltages, along with lower scale output voltages occur.
- Auto-resetting over current protection for short-circuit protection.
- Digitrax **LOCONET**<sup>™</sup> expansion network forms a simple, reliable interconnect between all Digitrax Command Control System components using RJ11 6 pin modular telephone cable jacks. Each booster has 2 daisy-chainable **LOCONET**<sup>™</sup> ports to allow cost-effective expansion of Digitrax equipped layouts. No tools required.
- High impedance balanced or unbalanced signal input receivers on the **LOCONET**<sup>™</sup> interface RJ11 connectors allow boosting of several different types of command control signals.
- Slew-rate controlled, monotonic and balanced track drive signals, for good decoder and RFI performance.
- Auto-shutdown on loss of command control drive signal, so layout will not convert to DC operation if a cable or connection is broken.
-  Track Status dual color LED indicates and diagnoses signals being fed to the track, e.g., if power is on the track, the sense and presence of analog zero stretching, etc.
-  A track power OFF switch allows suspension of track power while input power is still coming in to the booster.

### 3.0 **CHALLENGER**<sup>™</sup> Quick Installation Guide:







These simple instructions will get you up and running quickly. You can investigate the specifics later but, for now let's get your trains running. A full description of all controls and technical reference information is included in this manual.

See Challenger Quick Start Hook Up Diagram on Page 7.

- Connect the two RED push terminals marked POWER IN to the AC accessory output of your conventional power pack. Leave the power OFF for now. (Minimum input is 12V AC or DC. Maximum input is 4.5 Amps, 28V DC 81VA Continuous. Do not exceed 22V RMS AC or 28V DC input).
- Connect the two BLACK push terminals marked RAIL A and RAIL B to your layout. Remember "Black to Track." *Make sure no other power packs are connected to the rails used by the DB100a.*
- Connect the CT4 throttle to either of the **LOCONET**<sup>™</sup> RJ11 ports.
- Set the  Scale switch on the **DB 100a** to the scale you are running. (N, HO, O(G)S).
- Set the  MODE switch on the **DB 100a** to the RUN position.
- Turn all **CT4**  throttles completely counter clockwise to the STOP position.
- Place a digital and/or a conventional locomotive on the layout, and turn ON your power pack.
- On the **CT4** PRESS and HOLD the  RUN/STOP key until the **DB 100a** beeps once and the  TRACK STATUS indicator glows orange. The track is now ready to go. See page 10 for complete RUN/STOP instructions.
- The RED  throttle controls the conventional locomotive. The RED  direction arrow changes its direction. The conventional loco will hum when there is power on the track. Once it is running, the humming will decrease. The  TRACK STATUS light shows red and green when the conventional loco is moving forward or in reverse.

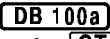
- J) The GREEN, BLUE & BLACK  throttles and their corresponding  arrow keys control your digital locomotives. Digitrax ships its decoders preprogrammed for the Group A "Black" throttle. So, when you install a new decoder it will operate on that throttle until you reprogram it. When you power up your Challenger, it defaults to Group A so, just turn the BLACK  throttle clockwise to start your digital locomotive. It should respond by going Forward. Press the BLACK  arrow key to change its direction. Section 6.0 Covers changing the locomotive addresses and other programming features.
- K) To stop all locomotives, press the  RUN/STOP key until you hear 4 beeps and everything stops. *Note: The lights will stay on.* Another short key press (about 1 second) on  RUN/STOP will restart all locomotives at their current throttle settings. To turn the track power OFF, hold down the  RUN/STOP key for a little longer (about 2 seconds), the **DB 100a** will give 2 beeps and the  TRACK STATUS lamp will go out indicating that track power is off. Of course, you can always turn track power off by setting the **DB 100a**  MODE switch to OFF. *Note: After turning off your power pack, the  POWER ON LED will continue to glow for several seconds.*
- L) For best low speed performance we recommend using the DB100a "N" scale setting (even if you are running HO). ***When running conventional locomotives we strongly suggest that you use the DB100a "N" scale setting to give quieter operation and create less heat in the engine.***
- M) Experiment by reprogramming and adding more digital locomotives. ENJOY the power of Digital. *Warning-*you may find it as addictive as popcorn at the movies!

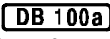

## 4.0 Memory Throttle Control Panel:

Only one  Memory Throttle should be plugged into the  ports on a  operating as a  Command Station. If you unplug the  while the track power is ON and locomotives are running, the  will remember your throttle settings until you plug the throttle in again. If you change the throttle settings while the CT4 is unplugged, the DB100a will send the new speed commands to the decoders as soon as it is plugged in again. To stop the layout or turn off track power you must have a throttle plugged in OR set the  MODE  switch to OFF.

Please refer to "CT4 Controls " Page 9, Figure 1.

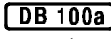

### 4.1 RUN/STOP

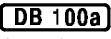
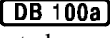
Switches the main track power on/off and toggles run/stop modes. The  senses either a short key press (press and release) or a longer key press (press and hold).

- Press and Hold  RUN/STOP to cycle track power on and off.  TRACK STATUS will glow when power is on.
- Press and Release  RUN/STOP to cycle the powered track from RUN(1 beep) to STOP(4 beeps) and vice versa.
- The  beeps 4 times to indicate that STOP is active and track power is on.
- When you send another short key press and release, the  beeps once and cycles from STOP to RUN and all selected locomotives resume operation where they left off.
- Use the STOP function to avoid collisions.

### 4.2 GROUP

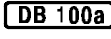
Allows the  to access the four different groups of four locomotives that are selected by throttle "color". This allows you to access up to 16 locos in 4 groups of 4 at a time. The color referred to is the color code on the control panel, not the actual color of any locomotive! We chose color coded throttles along with alphabetic Groups A to Group D because we found that both our beginning and advanced users prefer the ease of color coding as opposed to having to remember loco numbers when selecting addresses and remembering up to 16 different locomotives at a time.

- PRESS  Group, you will hear the  ticking.
- PRESS the  arrow above the group you want to access. GRP A, GRP B, GRP C or GRP D. Once you make your selection, the

**DB 100a** will stop ticking and beep once if you selected GRP A, twice for GRP B, three times for GRP C and 4 times for GRP D. You are now in control of the selected group of 4 locomotives.

Note: The **DB 100a** will not stop ticking and you will not be able to control any locomotive until you make a selection. Any locomotive that is left moving when you change groups will continue moving as commanded until its Group is selected again and new commands are sent or the track power is stopped or turned off. You can change Groups at any time. See TABLE 1 on page 23 for NMRA addresses.

#### 4.3 ADV/STD

Allows you to choose Advanced 28 speed step operation or Standard 14 speed step operation.



- PRESS  ADV/STD if the **DB 100a** beeps twice you are in ADVANCED mode: if it beeps once you are in STANDARD mode.

Digitrax decoders are programmable to operate in the Advanced mode for smoother 28 speed step operation or in the Standard 14 speed step mode to allow compatibility with less advanced systems. Digitrax decoders are shipped programmed in standard mode so, you will need to reprogram them in Advanced mode for best operation with your **CHALLENGER™** system. Decoders configured for Standard mode will display erratic directional lights if they receive Advanced DCC packets. The mismatch of Advanced and Standard modes between command station and decoder will not cause any other operational problems or harm the decoders in any way.

Note: Challenger powers up in Advanced mode so, if you need to run in Standard press the  to change modes.

#### 4.4 LIGHT

Toggles the light state of the locomotive selected.

- PRESS the  Light key. The **DB 100a** beeps and waits for you to select a locomotive as follows.
- If the loco you want to select is active in the current group simply press the colored  corresponding the that loco.
- If the loco you want to select is not in the currently active group, change groups and then change the light state.
- When you press the  making your loco selection, the locomotive's directional light will change from on to off or vice versa (the loco

will NOT reverse). The **DB 100a** will beep twice for lights on & once for lights off.

- If the light does not change as commanded, repeat the command sequence. Because the DB100a may not know the loco's current light state, it simply sends a toggle command. So, if the loco light is off and the DB100a expects it to be on, the DB100a sends an off command and the light doesn't change. Repeating the command will then turn the light on as desired.

*Note: The light key is also used in program mode to allow you to program decoder address **and** loco characteristics rather than just address. See section 6.3 for details.*

#### 4.5 ARROW/SELECT

These keys RED, GREEN, BLUE & BLACK to correspond to the  throttles. They are the REVERSE keys during regular operation and are SELECT keys for the lights on/off, programming & group selection functions.

#### 4.6 RED THROTTLE

- Turn counter-clockwise to reduce speed and STOP the corresponding locomotive. Turn clockwise to increase locomotive speed. During programming this knob sets the V-START value, see SECTION 6.4 page 24.
- The Red  throttle in Group A is reserved for analog (Conventional DC) loco operation.

#### 4.7 GREEN THROTTLE

- Turn counter-clockwise to reduce speed and STOP the corresponding locomotive. Turn clockwise to increase locomotive speed. During programming this knob sets the ACCELERATION value, see SECTION 6.5 page 25.

#### 4.8 BLUE THROTTLE

- Turn counter-clockwise to reduce speed and STOP the corresponding locomotive. Turn clockwise to increase locomotive speed. During programming this knob sets the DECELERATION value, see SECTION 6.6 page 25.

#### 4.9 BLACK THROTTLE

- Turn counter-clockwise to reduce speed and STOP the corresponding locomotive. Turn clockwise to increase locomotive speed. During programming this knob sets the V-MID value, see SECTION 6.7 page 25.

## 5.0 **DB 100a** Control Panel:

Please refer to "DB100a Controls" Page 14 Figure 2.

### 5.1 POWER INPUT

The two RED Push Terminals on all Digitrax Boosters and Command Stations are the power input connections. The current capacity is designed to drop off by about 10% at maximum operating temperature. **Never share a common power source between multiple Digitrax products.** Each unit should always have its own dedicated power source.

	AC 50/60 Hz	DC
Max Input	22V RMS AC	28V DC
Min Input	12V AC	12V DC
Max Input Current	4.5 Amps	4.5 Amps

#### TECHNICAL NOTES

To ensure protection from electrical shock, fire hazard or poor unit operation, the power input must be from a National Electrical Code Class II, UL listed Safety Extra Low Voltage (SELV) supply. The user assumes all risks associated with using a power supply that is not safety and capacity rated for driving the DB100a. A fuse or other positive overload safety device *must be present in the power supply leads*. In no case should the fuse rating be more than a 5 amp slow-blow fuse, and should be no greater than the current output capacity of the Class II power supply.

The power supply should not be shared with any other equipment, to prevent unexpected phasing or short circuit problems. To ensure correct RFI performance the power input must be floating in that neither lead is connected to the Safety ground of a typical 110V power cord. The AC power safety ground should be connected to the GRAY GROUND terminal on the DB100a. Minimum input voltage is 12V DC or 12V AC rms to ensure correct operation of internal logic. The power to the DB100a should not be rapidly cycled ON-OFF-ON. When power to the unit is switched off, wait 30 seconds before turning on the power again.

The unit is designed to absorb and dissipate the power difference between the input voltage and the selected scale output stabilized voltage, at the current load being drawn. This means that large input voltages when smaller output scale (e.g., N scale) voltage limits are selected will cause greater heat buildup in the unit, as the output load current is increased to the maximum. Over temperature thermal shutdown may occur in this situation. This protects the components from thermal stresses that degrade long term reliability. The ratings and "operating envelope" of Power Input and Output are conditional on not generating over temperature conditions. Over temperature is not directly injurious to the DB100a or its reliability, but will cause the inconvenience of automatic temporary suspension of track power. Each installation will be affected differently due to normal room temperature, cooling airflow around the DB100a, scale voltage in use and load current draw. Over temperature shut down is usually not encountered except in the case where a user is pushing for maximum available power rating.

## 5.2 ○ POWER ON INDICATOR

This green LED indicator glows when input power is ON. The **DB 100a** will indicate power ON in most situations because it draws less than 1 watt when on Standby with Track Power OFF. The ○ POWER ON LED will continue to glow for several seconds after power to the unit is turned off.

## 5.3 GROUND

The **LOWER GRAY** terminal provides electrical safety features and an RF ground reference for minimum radiated noise. It should be the **ONLY** point of any **DB 100a** installation that is connected to the AC safety ground pin provided on most 3 pin 110V AC power sockets.

### TECHNICAL NOTES

If the power outlet is a 2 pin ungrounded unit, this ground terminal can be connected with a GREEN 14 AWG multi-stranded conductor to a cold metallic water pipe ground, as defined in the National Electrical Code. This is a safety precaution that should not be ignored.

## 5.4 RAIL A RAIL B

Connect these two **BLACK** terminals to the track or track feed conductor bus on all Digitrax Boosters and Command Stations. Remember: "Black to Track".

### TECHNICAL NOTES

The output is a **BALANCED** drive to the two track lines. This means that the two track terminals both develop drive voltage with respect to the **GRAY** ground terminal and neither track lines or extensions of them should be shorted to ground. In addition, the two terminals are driven "out-of-phase" so that while one is at a small voltage with respect to ground, the other is at a larger voltage with respect to ground. This is a characteristic of the DCC command signal and the *balanced* line drive helps keep unintended radiated radio emissions to a minimum. The implication for you as a user is that the track sections must be isolated, and "phase" of each track, i.e., the side that is connected to the RAIL A of a Digitrax track terminal, is important. This issue will be important on large layouts where the layout is isolated into many sections with individual Boosters driving them. This is very beneficial in a DCC driven layout because it allows the rest of the layout to keep running even when an isolated track section experiences a short-circuit or problem; such as a derail or balky switches that shut it down. This is similar to "blocking" in a conventional layout. With DCC this is a recommended but, optional layout practice.

Connections to a large layout should be via a parallel conductor power bus similar to the recommended practices used in most conventional layouts, with appropriate larger copper conductors feeding taps up to the track every 10 feet or so. It is advisable to keep all conductors twisted to keep the geometry best for minimum RF radiation. Some experimentation may be needed on your layout to ensure no circulating ground loops are present. Try to wire all the power feeds away from the boosters and command stations, in a radial "star like" configuration so no large "magnetic induction" loops are created. **It is not possible to place filter or ANY capacitors across the track as these will short out the DCC signals. Be sure that no capacitors are bridging your DCC sections.**

When converting between Digitrax DCC track sections and adjacent conventional DC powered tracks, **both rails must have insulating gaps**. The DC supply *must have*



*some form of current control*, we recommend a 5 Watt to 10 Watt 12 Volt lamp be placed in series with one of the DC power pack supply leads. This allows the DCC booster to drive the locomotive properly onto the DC track with minimum interruption and stress to the Booster and decoders and locomotive wheels. The lamp will light as the locomotive bridges the gaps. You should try to cross these gaps quickly and not bridge the two systems for any longer than necessary.

## 5.5 ○ TRACK STATUS INDICATOR

The brightness of the ○ Track Status LED shows the voltage on the track drive terminals. The color indicates the signal type. If it is orange the track is getting normal DCC signal with no analog zero stretching. See below.

### TECHNICAL NOTES

The color of the TRACK STATUS led is an indication of the signal type. If it glows orange, the track sees a normal DCC signal with no "zero stretch," and a conventional locomotive on the track will hum gently and not move. If the color is green, a negative "stretched zero" signal is being boosted for operation of a conventional locomotive. A red led color indicates a "zero stretch" analog signal is being transmitted to the rails for a conventional locomotive to be operated in the reverse direction. The DCC decoder equipped locomotives are still reading their Digital commands normally and performing as commanded. If the Track Status LED is not lit there is no voltage on the track, the track power to the DB100a may be OFF. Note that during short-circuit faults, a sophisticated recovery strategy is being executed by a DB100a that will periodically attempt to restore power to the track.

## 5.6 ○ OVER TEMP INDICATOR

The **DB 100a** will automatically shut down when the heat sink temperature rises to approximately 45 to 50 degrees Celsius and the ○ OVER TEMP indicator will glow red. The **DB 100a** automatically resumes operation when the heat sink cools down to approximately 40 degrees Celsius.

### TECHNICAL NOTES

If the unit shuts down frequently try the following remedies;

- move the unit so that the heat sink has an unimpeded flow of cool air
- lower the track load current
- reduce the input voltage
- place the unit out of direct radiant heat e.g. sunshine or room heater
- try direct cooling air onto the heat sink from a small fan.

Note that if the unit is being run too close to its preset current limit, it may clip or mutilate some outgoing packets to keep the track current within acceptable limits. If this happens often, the DB100a will react like there is an overload and briefly shut down and beep 5 times. In this case the track is not truly short circuited, but overloaded. Reduce the track current load, or partition the layout into more isolated DCC sections, using additional boosters.

The DB100a current limiting strategy is very safe for use with your expensive brass locomotives, and *WILL NOT* weld them to the track if derailed. The DB100a senses the short

circuit very quickly and shuts down track power if the problem persists for more than a few thousandths of a second. The unit will back off and beep 5 times giving a few second delay before sensing if the fault has been cleared. The resetting strategy is sophisticated to be sure damage is not likely during a track fault. The unit automatically and conveniently powers up the track again when the fault is cleared.

### 5.7 SYNC

The units **UPPER GRAY** terminal allows the connection of expansion boosters without repeating the actual signal on the track drive terminals. The use of this terminal is specific to each Digitrax booster and command station. It allows you to choose how you will use the **DB 100a**. You decide whether the **DB 100a** is simply a Booster, an "Intelligent Auto reversing"™ booster or a multi-featured **CHALLENGER**™ Digital Command Station.

### SET UP OF **DB 100a** OPERATIONAL MODE

#### 5.71 **CHALLENGER** DIGITAL COMMAND STATION MODE:

If you don't connect the gray terminals (SYNC & GROUND) or if you connect them with a BC-2 Cable to run slave boosters on your system, the **DB 100a** will select the command station mode when it initially powers up. Use the BC-2 cable when the Sync terminal is driving slave boosters on the system. An example of this is using a second **DB 100a** running as a booster in the Intelligent Auto reversing™ mode to automate a reverse loop.

#### 5.72 SIMPLE BOOSTER MODE:

Connect the two gray terminals, SYNC & GROUND, with a short length of wire, to select the **booster** mode when **DB 100a** is initially powered up. Connect to other **DB 100a**'s using BC-2 cable described on page 28.

#### 5.73 INTELLIGENT AUTO REVERSING™ BOOSTER MODE:

Connect the two gray terminals, SYNC & GROUND, with a short length of wire and set the  Mode switch to P/R to select this mode on initial power up. Connect to other **DB 100a**'s using BC-2 cable described on page 28.

Note: Additional DB100a boosters can be wired to boost directly the voltage seen on the track terminals of a "Challenger"™ Command Station. This arrangement has inferior DCC signal noise-performance, since the slaved boosters will repeat the motor brush noise from locomotives on the track section being directly driven by the "Challenger"™ configured DB100a.

### 5.8 **LOCONET**™ PORTS A & B

These are the access ports for expanded Digitrax systems that allow you to simply daisy chain additional Digitrax products using cost-effective phone style flat cables. These ports also allow you to connect the **CT4** to the **DB 100a** for **CHALLENGER**™ mode operation. *The **CT4** or CTX throttles should not be plugged into any **LOCONET**™ port other than a DB100a running as a "Challenger"™ Command Station.* The 4 throttle configuration of the **CT4** DOES NOT allow more than one **CT4** to be connected to a **DB 100a** at the same time without throttles interfering with each other. Up to 4 CTX/CTY throttles can be plugged into a **DB 100a** operating as a **CHALLENGER**™.

For your tinkering enjoyment we encourage you to build one or more CTX/CTY throttles and customize them the way YOU like them. Since they are single throttles, two or more units can be hooked up at the same time and will not interact as long as the users select different throttle "colors" or locomotive addresses. Make sure you always connect ALL 6 of the RJ11 plug wires to the CTX/CTY or **CT4**, and any cables and jacks you decide to add to your layout.

#### TECHNICAL NOTES

Radio Shack's RJ11 6 conductor 25 foot extension cable #279-422 is ideal for extending your "Challenger"™ throttle bus. *Note that this is a "reverse" wired cable so female/female 6 pin connector blocks should be of the "reverse polarity" type, in that pin 1 is connected to pin 6, etc.* We have tested up to 100 feet of throttle bus with, multiple jack taps, extending from a DB100a with no problems. The DB100a uses sophisticated logic and data filtering to decode the operation of CT4 and CTX throttles, even so it is advisable to route the cables carefully to minimize the pick up of AC "hum" and noise. You can also use regular 3 pair AT&T Internal Wiring solid conductor twisted pair wires. These actually have superior noise rejection due to their balanced twisted pair construction. Be sure not to transpose wire colors, if so the CT4 functions will be confused until you *untangle* the crossed wires!



The pinouts for the two RJ11 6 pin connectors are identical, and they are wired in parallel. Looking into the DB100a, pin 1 is in the Telco standard position to the RIGHT side. We use the convention of white conductor in the cable to pin 1:



PIN#	WIRE COLOR	NAME
1	White	RAIL_SYNC-
2	Black	GROUND
3	Red	LOCO_NET-
4	Green	LOCO_NET+
5	Yellow	GROUND
6	Blue	RAIL_SYNC+



The signals RAIL\_SYNC+ and - are used by the booster modes of the DB100a. These are high impedance differential line decoder inputs that may be used to connect a command control signal for boosting to the track. They have an input common-mode range of +/- 20V with respect to the ground terminal. The differential drive signal should be above 2 volts, as input hysteresis is built in. Common mode rejection on the input allows the unit to boost from a different system without sharing ground connections and needing "opto-isolation". Just connect RAIL\_SYNC- to the ground reference of the signal source and RAIL\_SYNC+ to the signal, assuming a signal of say +/- 5 V. For an input signal on RAIL\_SYNC+ that swings from ground to say +5V, connect the system grounds and connect RAIL\_SYNC- to ground via a 22 Kiloohm 1/4 watt resistor.

## 5.9 MODE SWITCH



This is the most important operational control on your booster. If the **DB 100a** is configured as a booster it controls whether track power is on. If the **DB 100a** is running as a **CHALLENGER™** Command Station it controls whether the track power is ON or if programming operations are enabled.

When the **DB 100a** is a booster, (determined by SYNC terminal connection at input power on, see 5.7) turn the switch  OFF to turn off track power even if input power is present. Moving the switch to  P/R tells the unit to be an Auto Reversing Booster and  RUN tells it to be a regular Booster. *Switching to the P/R setting after initial power on will not change the auto reversing characteristics until the unit is turned off and powered up again.*

When the **DB 100a** is operating as a **CHALLENGER™** Command Station, the  OFF mode switch setting turns OFF track power and SYNC drive signal to expansion boosters. They in turn, switch off their track power due to loss of the DCC drive signal. If the mode switch is returned to RUN or P/R the track power and SYNC drive will **NOT** restart until commanded by a **CT4** 

RUN/STOP key stroke. The  OFF switch setting will override any **CT4** throttle track POWER ON request. Resumption of track power by a "Challenger"™ is followed by 'broadcast reset' packets sent to initialize all DCC decoders when track power is turned on and the unit goes into the RUN mode. To stop the layout, briefly press the **CT4**  RUN/STOP key. The booster keeps track power on, beeps 4 times and sends 'BROADCAST EMERGENCY STOP' packets to stop all loco decoders. This is the only way to guarantee some older mobile DCC decoders will halt whenever you need to STOP NOW!

To enter the programming mode move the Mode switch to the  P/R position. Programming and programming track operation is fully detailed in Sections 6.0-6.10 on Pages 23-27.

Setting the MODE switch to  RUN enables the **CT4** to perform its Run/Stop functions (See Section 4.1 Page 10. This is the normal position for operating the layout. Note that changing the MODE switch from "OFF" position to "P/R" or "RUN" will not actually turn ON the track power but enable the **CT4** to select the exact state desired using the  RUN/STOP key.

## 5.10 SCALE VOLTAGE SWITCH (O/G HO N)

This switch sets the maximum track Voltage limit appropriate for the selected scale. These settings allow operations of locomotives at levels close to the S9 NMRA values.

SCALE	MAX TRACK VOLTAGE
N	12V
HO	15V
O/G	20V

### TECHNICAL NOTES

- For **N scale** the limit is approximately +/- 12V peak on the track and is a couple of volts less at the motor brushes in a locomotive, accounting for rectifier diode and transistor voltage drops and booster output voltage drop due to full load current.
- For **HO scale** selected the output voltage is approximately +/- 15V peak to allow full voltage at the motor brushes after decoder losses.
- For **O/G scale** the output voltage is approximately +/-20V, for operation of locomotives that need a higher maximum brush voltage.

The unit will deliver up to the maximum rated output current irrespective of the scale switch setting, unless there is an over temp shutdown. The peak input voltage can be up to 4 Volts higher than the peak scale voltage to allow full output stabilization. If the input voltage drops below the differential needed for full stabilization the output voltage will be below the stabilized Scale voltage. Selection of the correct scale voltage protects against the track receiving too much voltage for that scale. The characteristics and reliability of the DCC signal format are such that ripple or noise experienced at the **PEAK** excursion of the DCC wave form is entirely rejected by the system. Only the signal transitions around approximately +/- 4 Volts have any effect on the quality of packet reception. To minimize problems in this area and to allow insertion of other high frequency signal components, the Digitrax DCC output wave forms have been engineered to exhibit a fast and precisely controlled slew rate in the critical transition zones. For this reason, line ripple from AC power feeds, and low input operation (above the minimum input voltage) will not adversely affect system control, but may lower the available motor power. Note that "torque" beats may occur if large amounts of power line ripple are present close to the PWM motor control frequency used in the decoders, especially in the lower mass N scale motor units.

It is technically feasible to impress other carrier currents on the track, for example FM-subcarrier sound products. These must be carefully combined with the DCC track drive signal. These signals should be in the range of about 50KHz to 200KHz maximum, with a peak voltage measured on the track of no more than 15% of the peak Scale voltage. Due to variability in technologies and implementations, Digitrax cannot warrant performance of the DCC signal in the presence of other signals. We encourage users to experiment with the possibilities. Note that the signal must be BALANCED and impedance limited at the 9 KHz primary frequency of the DCC. It is probably easiest to couple into the track with the secondary winding of a High Frequency transformer with a series DC blocking capacitor. A small inductor should be placed in the track feed from the booster so the low drive impedance of the booster does not suppress the signal to be

added. A purely resistive balanced feed can be employed but will be very inefficient at the low impedance levels needed.

## 6.0 Decoder Programming and Configuration:

The **DB 100a** running as a **CHALLENGER**™ Command Station with a **CT4** Memory throttle programs loco addresses 01-15, start voltage, mid point voltage, acceleration and deceleration rates for DCC compatible decoders easily and automatically.

### 6.1 LOCOMOTIVE ADDRESS SETTING:

The actual address programmed into the decoder corresponds to NMRA address codes 01 through 15 (See Table 1 Below). To make it easier to keep track of "who's on first" the Challenger System translates these address numbers into 4 Groups of 4 locomotive throttle colors. If a DCC compatible digital locomotive is placed on the programming track with an address out of the Challenger range of 01 through 15, you can easily reprogram it to one of Challenger's available addresses.

NMRA ADDRESSES AS THEY CORRESPOND TO CHALLENGER COLOR CODES





	RED 	GREEN 	BLUE 	BLACK 
GRP A	CONV	01	02	03
GRP B	04	05	06	07
GRP C	08	09	10	11
GRP D	12	13	14	15

TABLE 1

### 6.2 PROGRAMMING TRACK:

We recommend that you use an electrically isolated section of track for programming decoders because, the programming information sent by Challenger is a broadcast signal that will be seen by all locos on powered track sections. In a broadcast programming scenario this saves great aggravation because a user could accidentally re-program all mobile decoders in one fell swoop! When operating in **Advanced Mode** and programming instructions are sent, the SYNC output is suppressed. This causes all slave boosters to turn OFF so that all locomotives on slave-boosted sections **will not receive the Programming instructions**. This allows the operation of a designated "programming track" to be fully automatic if you are operating in Advanced mode. Only locomotives on the "programming track" will be affected by programming.

An electrically isolated siding works very well as a programming track when no slave boosters are present (See Page 24 Figure 3).

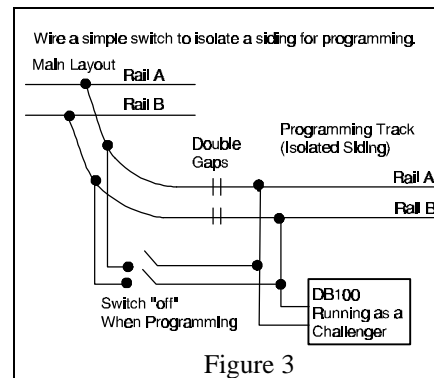











Figure 3

## 6.3 HOW TO PROGRAM DECODERS:

Note: According to NMRA RP 9.2.3 you are required to use a low power setting for programming decoders. Digitrax does not feel that this extra step is necessary once you have successfully installed the decoder in the locomotive. If you are reprogramming an installed decoder, feel free to proceed to step A below. If you wish to use a low power setting

for decoder programming, please see your decoder manual Appendix A for decoder initial test procedures which detail the use of a protection resistor to provide a low power programming option. This option can be used for all decoder programming if you wish. Digitrax recommends that you use low power programming for initial decoder tests prior to installation in the locomotive.

- Set up the **DB 100a** to operate as a **CHALLENGER**™. See Page 19 Section 5.71 "CHALLENGER DIGITAL COMMAND STATION MODE"
- Set the  MODE switch to P/R to enable programming. Just moving the MODE switch from OFF through P/R to RUN won't result in any programming activity. Programming can only be initiated by positive **CT4** key strokes.
- All locomotives that are running will immediately STOP.
- Place the locomotive with the decoder installed on the isolated programming track. Be sure power to main layout is switched off.
- Choose whether you want to program in Advanced or Standard Mode by pressing the  Adv/Std key. One beep indicates that you are in Standard mode(14 speed steps) and Two beeps indicates that you are in Advanced mode(28 speed steps).
- If you only wish to program the ONLY the decoder address proceed with steps G, H & I. If you wish to change the locomotive's address & operating characteristics (Advanced/Standard Mode, Start-Voltage, V-Mid, Acceleration & Deceleration) go to step J on the next page.
- If the loco you want to program is in the currently active group go to step H).If the loco you want to program is not in the currently active group you will need to change to the chosen group by pressing  Group followed by the  above the desired group (A,B,C or D).
- Press the  Arrow to program the locomotive decoder to the color (within the group selected) you want to use. When you press the  Arrow key, several automatic programming bursts are sent to the decoder. When a Digitrax decoder equipped locomotive accepts programming commands, it chirps several

times, if you listen closely to the locomotive, you will know your commands were received. The **DB 100a** beeps once for the Red  Throttle, twice for the Green  Throttle, three times for the Blue  Throttle and four times for the Black  Throttle to indicate which throttle it is programming.

- I) Once these steps are complete, move the DB100a Mode switch to "Run" & Press "Run/Stop" to resume operations.
- J) If you want to change the loco's operating characteristics **AND** address. Set the operating characteristics you desire for your locos using the throttle knobs. When the **DB 100a** is in the programming mode, the throttle knobs take on the following meanings to allow you to set the operation characteristics you want for your individual locos.

**6.4 RED  THROTTLE = V-START:** Turning this knob clockwise adds power to the initial speed step used by the decoder. This means that the locomotive will start at a higher initial speed as soon as a speed is commanded. Turn the knob completely counter-clockwise to set a zero V-START value.

**6.5 GREEN  THROTTLE = ACCELERATION RATE:** Turning this knob clockwise causes the decoder to respond more slowly to a command to increase speed. This simulates heavier train weights. Turn the knob completely counter-clockwise to set the decoder to zero or NO inertia for quicker response.

**6.6 BLUE  THROTTLE = DECELERATION (BRAKING) RATE:** This knob sets the rate at which the locomotive slows down to the selected speed, this creates simulated braking rate. Turning the knob completely counter-clockwise sets a zero braking rate for fast locomotive stops.

**6.7 BLACK  THROTTLE = V-MID:** This is a subtle adjustment that allows you to tweak the "power" curve of the locomotive motor and drive train. This adjustment sets the power to which the mid-throttle code corresponds. A high value (more clockwise) will cause the initial speed values to give greater speed increases per step and appear to give power more rapidly at lower throttle settings. Conversely a smaller value will appear to flatten out the initial throttle response. If you do not want to experiment with this feature set the knob completely counter-clockwise (stop) and zero will be programmed. Digitrax decoders will program for a normal straight-line power curve. This adjustment can only be programmed from Digitrax Command Stations running in ADVANCED MODE and, once programmed, the decoder retains and utilizes the established

V-MID characteristics whether it is run in Standard or Advanced operating mode. For further details see the Digitrax Decoder manual.

NOTE: When setting the ACCEL and DECEL programming values to simulate prototypical operation, try keeping the DECEL (braking) values significantly LESS than the ACCEL values. Once you get used to prototypically slow braking rates you will be able to judge stopping distances better and you won't have too many wrecks! To override slow deceleration rates to avoid a collision you can use the  Run/Stop key to send an emergency STOP.

Once you have set the characteristics you want, press the  key and go back to steps G, H & I to complete the programming sequence.

## 6.8 PROGRAMMING FOR MU OPERATIONS:

If you want to run more than one powered locomotive in a multiple unit lash up, simply place all the units together on the programming track and program them with the same address and operating characteristics. They will all operate on one throttle. We recommend that you choose units that have similar motors and have similar physical operating characteristics. If you want to have one loco run "backwards," as is prototypical in some situations, you can wire that unit's decoder motor leads "backward" so that when the lashup is commanded to move forward it will look like one unit is running in reverse.

## 6.9 DIGITRAX CONFIGURATION REGISTER:

For convenience, the **CHALLENGER**™ automatically programs this register in Digitrax decoders with Analog mode conversion Enabled, and sets the Advanced mode flag if the unit is *currently in "Advanced" mode*. Otherwise, Standard mode is programmed.

Other programmers can be used to program Digitrax decoders. Specifically, procedures for using the Marklin 6032 programmer are detailed in the Decoder Users manual.

You can use a CTX/CTY throttle to successfully program on the **CHALLENGER**™ Command Station, but by the same token you could walk all the way from San Francisco to Washington to avoid driving! Our advice is that you use the **CT4** for this task....

## 6.10 PROGRAMMING OTHER DCC COMPATIBLE DECODERS:

The **CHALLENGER**™ can program other DCC compatible decoders that do not implement ADVANCED 28 Speed Step Operation if the  ADV/STD Key is set to STD mode before programming is initiated. The addresses programmed will correspond to the NMRA Address chart in Table 1. If all throttles are

closed (counter-clockwise) the nominal value "0" will be loaded into the decoder's control registers. This should give correct operation. *This "0" value may not be read back correctly by some programmers although the decoder will operate properly.* You can always program values that are within a particular system's operating range with that system's programmer.

When programming Lenz and Arnold decoders with the Challenger, it is necessary to power them down and back up again after programming to allow them to reset and update the newly programmed values.

## 7.0 Operational Considerations:

### 7.1 MIXED DCC AND CONVENTIONAL OPERATION:

When a Digitrax locomotive decoder that has been operating on a conventional DC track crosses the isolating gaps to a DCC track section, the locomotive will receive a stop command and will come to an inertial or braking rate stop, until it receives a digital command addressed to it. This allows smooth transitions between differently powered track sections on your layout. This gives a smooth prototypical conversion. You should be aware that while operating on the conventional section the decoder is effectively at FULL throttle. When braking is commanded, if the braking rate is set too slow, it may appear that the locomotive is surging ahead out of control. It *will* come to a stop at its programmed braking rate. If the command addressed to the decoder on re-entering the DCC section would cause it to "bounce" back into the just exited DC powered section the locomotive will STOP until the DCC command direction agrees with the incoming locomotive direction.

### 7.2 BC-2 CABLE AND CONNECTING MORE THAN ONE DB100a:

Several **DB 100a**'s can be used to operate your layout. You may wish to automate a reversing loop or simply need to add more power to run a large layout by using added slave boosters. To accomplish this you can build your own BC-2 cable according to Page 28 Figure 4. Please note that if you are using more than one slave you need to add the optional zener diode to the cable. You only need one BC-2 to connect the DB100a with the first slave booster, additional boosters can be connected with regular 6 conductor RJ11 extension cables per diagram below.

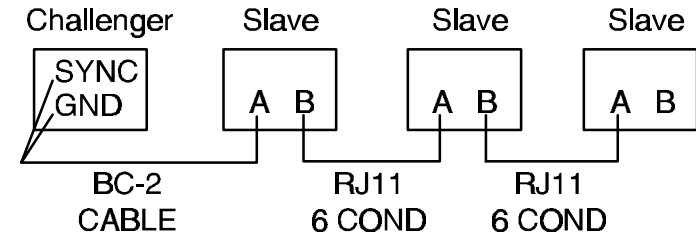

## BC-2 Cable Assembly Instructions

For connecting slave boosters to the Challenger System.

Note: Optional zener diode is required for hook up of multiple boosters.

### Parts List for BC-2

	Description
1	Part of 25' 6 Pin/ 6 Conductor Cable with RJ11 6 Pin Plug.
1	10 kohm Resistor 1/4 watt, 5%
1	1 kohm Resistor 1/4 watt, 5%
1	2.7v/500mw Zener Diode
	Heat shrink tubing

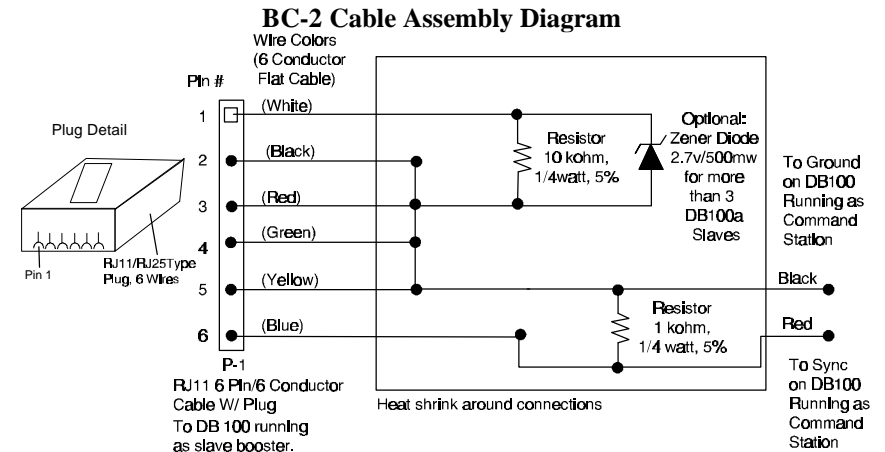



Figure 4

## Connecting More Than One DB100a

### 7.3 INTELLIGENT AUTO REVERSE OPERATION:

See Figure 5 on Page 16&17 for hook up diagram.

If "Intelligent Auto reversing"™ is in use on a reversing loop and a locomotive 'stalls' at the track isolating gap and both boosters enter current limit shutdown (beeping), be sure that the slave booster's  MODE switch is set to P/R to enable the auto reverse feature. Note that two auto reversing **DB 100a**'s across a single isolating gap will phase-reverse in an indeterminate manner depending on which booster attempts a reversal first, to clear the track fault. This will cause no damage to either unit. A **DB 100a** running as a **CHALLENGER**™ Command Station can not perform the auto reverse function at the same time since it cannot be allowed to phase change on fault because it is the master system phase reference. In order to run the auto reversing feature on a **CHALLENGER** equipped layout, you will need an additional **DB 100a** to use as a slave booster to enable the reversing loop. Note that any conventional non-decoder equipped locomotive in a booster section that undergoes an 'auto reverse' will change direction involuntarily; DCC locomotives will continue in the direction commanded.

If a **DB 100a** is used as slave booster driven from a **CHALLENGER**™ or other command station and the DCC signal is turned off, the booster detects the "loss of carrier," beeps, and goes off-line with track power turned OFF until the DCC signal is restored. On a Digitrax layout, if the Master command station forces a track power shutdown, all the slave boosters will "chirp" as they shutdown!

## 8.0 Troubleshooting:



### 8.1 Clean Track

The majority of intermittent operation faults can be traced to bad connections and poor or noisy wheel pickups on locomotives. Check track cleanliness and quality of wheel pickups. The DCC digital packet communication strategy performs exceptionally well in a less than perfect environment, and will often mask bad connections until they are really impossible to work with!

### 8.2 Reprogram the Decoder

If you cannot figure out what a locomotive is doing or "who" it is by address, do not panic! Just reprogram the locomotive. If you program with all throttles at Stop position, the nominal setup will be programmed and that is guaranteed to get the attention of a confused locomotive!

### 8.3 Emergency Stop

If the layout starts to "get away" on you, either PRESS  or, turn the track power  OFF on the **DB 100a**. Either way will give you a chance to regain your composure, and you will be able to rejoin the contest against many locomotives at once!

### 8.4 Mechanical Drive Train Problems

Pay attention to the mechanical drive train and free movement of the locomotive wheel sets. This is especially important with inexpensive locomotives. Using Digitrax decoders with appropriate programming settings, you can achieve surprisingly good quality motion, if you carefully audit the mechanisms for smooth running.

### 8.5 Strange Lights (not the ones in the sky)

If the light operation doesn't seem right, be sure that the current operating mode is the same as the decoder mode. If you aren't sure whether the locomotive is using Advanced 28 speed steps try changing the **CHALLENGER**™ to the Standard speed mode by pressing  and see if the lights work properly. Remember, you can always easily reprogram the locomotive to the mode you prefer to use, and that the program operation will force the locomotive to the mode that you have currently selected. See Section 4.0 Page 10 (CT4) and Section 6 Page 23 (Programming).

### 8.6 FCC Information

#### **Radio or TV Interference: (this information is MANDATED by the FCC)**

This equipment has been tested and found to comply with the limits for a Class B digital device, pursuant to part 15 of the FCC rules. These limits are designed to provide reasonable protection against harmful interference in a residential installation. This equipment generates, uses and can radiate radio frequency energy and, if not installed and used in accordance with the instructions, may cause harmful interference to radio communications. However, there is no guarantee that interference will not occur in a particular installation. If this equipment does cause harmful interference to radio or television reception, which can be determined by turning the equipment off and on, the user is encouraged to try to correct the interference by one or more of the following measures:

- Reorient or relocate the receiving antenna.
- Increase the separation between the equipment and the receiver.
- Connect the equipment into an outlet on a circuit different from that to which the receiver is connected.
- Consult the dealer or an experienced radio/TV technician for help.

Note that any modifications to the equipment not expressly approved by Digitrax voids the user's authority to operate under and be in compliance with CFR 47 rules, as administered by the Federal Communication Commission. Digitrax believes any conscientiously installed equipment following guidelines in this manual would be unlikely to experience RFI problems.

## 9.0 Warranty and Repair Information:

### DB100a, CT4 & Challenger Systems

One year guarantee on CT4 & DB100a. The CT4 Throttle and DB100a are not user serviceable (opening the case voids your warranty). If a defect occurs, return the unit to us for service. We will repair or replace these units at our discretion at no charge to you for one year from purchase date. This warranty excludes damage due to abuse. We will make any repair needed because of physical damage or electrical abuse at fair and reasonable rates.

### Decoders

Digitrax carefully tests every decoder we ship to be sure that you receive reliable products. Because we want you to be comfortable installing your own decoders, we outline a decoder test procedure that you can perform so that you can be sure your decoder works before you begin installing it in your locomotive. If, within 60 days of purchase, your decoder fails to pass the decoder test procedure outlined in the instructions, we will replace it free of charge to you. Because we can't control the actual decoder installation we can't cover your decoder once you have tested it and started the installation. In the event that you somehow manage to "blow-up" one of these little guys, we will repair or replace it for a nominal fee (call for the current amount) if you return the decoder to us.

Do not remove the shrink-wrap protective sleeves from Digitrax decoders or open the Command Stations or other products. None of the units have user serviceable parts, and opening them will void ALL warranty protection. If you are returning a decoder that failed the **test procedure**, all wires must be their original lengths. Do not cut any wires or install any units until you are sure they have passed the Decoder Test Procedure detailed in the Decoder Manual. Please don't return *anything* to Digitrax without calling and getting return instructions.

In order to make sure we give you the best service possible, please call (404)441-7992 to let us know before you send anything to us for service or as a return.

All warranties on Digitrax products are limited to refund of purchase price or repair or replacement of Digitrax products at the sole discretion of Digitrax. In the event that Digitrax products are not installed or used in accordance with the manufacturer's specifications, any and all warranties either expressed or implied are void. Except to the extent expressly stated in this section, there are no warranties, express or implied, including but not limited to any warranties of merchantability or fitness for a particular purpose.