



**Super Premium
Digitrax Complete Train Control
Starter Set Manual**

Includes Instructions for:
DCS100 Command Station Booster
DCS200 Command Station Booster
DT402 Series Throttles
Duplex Radio Operation with UR92 & DT402D
Simplex Radio Operation with UR91 & DT402R
Infrared Operation with UR90 & DT402
Walkaround Operation with UP5



Digitrax, Inc.
2443 Transmitter Road
Panama City, Florida USA 32404
(850) 872-9890 Fax (850) 872-9557
www.digitrax.com

Digitrax Manuals & Instructions are updated periodically.
Please visit www.digitrax.com for the latest version of all
manuals & for available firmware updates.
This rev 2.2 manual was updated 02/14.

Introduction

Congratulations on your purchase of a Digitrax Super Chief Xtra Complete Train Control Set!

The design of the Digitrax Complete Train Control system lets you operate your layout the way you want to. With LocoNet you simply connect system components to build the layout control system that you've always wanted! The Digitrax system reduces and simplifies layout wiring for new layouts. If you already have a layout, you probably won't need to rewire to install Digitrax.

Your Super Chief Xtra Starter Set has several components:

- **DCS100** is your system's command station. It generates the information packets that tell the decoders what to do.
- **DCS100** is also a booster. Boosters receive signals from the command station, amplify them and put them on the track along with the power from the power supply to run the locomotives. You can have several boosters on your layout to provide additional power to run more locos.
- The **DT402** or the **DT402D** is the throttle that comes with your Super Chief Xtra Starter Set. Throttles are the handhelds you use to tell the command station what you want the decoders to do. You will probably have several throttles on your layout if you have more than one person running trains at a time.
- A **UP5** Universal Panel for memory walkaround operation or a **UR92** Duplex Radio Transceiver for duplex radio or IR operation.
- **LT1** LocoNet and Decoder Tester.
- A 2' LocoNet Cable so you can get started right away.

In addition to your Super Chief Xtra you'll need:

- A power supply (you may be able to use one you already own)
- One or more mobile decoders for your locomotives.

This manual contains information about running your layout with infrared and/or Duplex Radio operation. Information about simplex radio operation is included for your convenience even though your Super Chief Xtra Set is not available with this option.

There are many different combinations of Digitrax components that can be used to set up a layout control system that is right for you. You can combine Digitrax products with compatible decoders, boosters and computer software made by other companies that build compatible equipment.

Your success with & enjoyment of our products are very important to us. After all, this is a hobby and it is FUN!!! Please read this manual carefully before installing your system. We have included lots of hints and operating ideas based on our experience. If you have questions not covered by this manual please contact your dealer or visit our web site at www.digitrax.com where the Digitrax online Tech Support Depot is always open!

Digitrax Super Chief Xtra Starter Set Manual

Table of Contents

Introduction	1
1.0 Super Chief Xtra Quick Start Guide	7
1.1 Connect the DCS100 to the power supply	8
1.2 Connect Your DT402 Series Throttle to the DCS100	8
2.0 Super Chief Xtra Quick Start Duplex Radio Operation	9
2.1 Install the UR92	9
2.2 Join Your DT402D Throttle to a Duplex Group	10
3.0 DT402 Installation	11
4.0 Additional Quick Start Basics	12
4.1 DT402 Throttle Start Up	12
4.2 DT402 Series Throttle Keyboard Layout	13
4.3 DT402 Series Throttle Controls At A Glance	14
4.4 Track power on and off	15
4.5 Select and Run An Analog Loco on Address "00"	16
4.6 Select and Run A Decoder Equipped Loco	17
4.7 Shutting Down the System	19
4.8 Resuming your session	19
4.9 Quick Start Problems?	19
4.10 What's Next?	20
5.0 LocoNet: The Digitrax Difference!	21
5.1 System Architecture	21
5.2 Event Driven or Polled?	21
5.3 Network Speed	22
5.4 LocoNet Personal Edition	22
5.5 LocoNet Expansion	22
5.6 LocoNet Wiring Components	24
5.7 Making LocoNet Cables	24
5.8 Testing LocoNet Cables with an LT1	24
5.9 LocoNet Throttle Jacks and LocoNet Connection Jacks	25
5.10 Installing the Universal Panel (UP5)	25
5.10.1 Hooking up the UP/UR's Track Status Indicators (Optional)	26
6.0 Advanced Installation of Digitrax On Your Layout	27
6.1 Setting Up A Programming Track	27
6.1.1 Ops mode programming	27
6.1.2 Service mode programming (Using a programming track)	28
6.2 Direct Home Wiring vs. Common Rail Wiring	28
6.3 Recommended wire sizes for power bus and track feeders	29
6.4 Other Track Wiring Considerations	29
6.5 Layout Power Districts	29
6.5.1 Number of Locos	30

6.5.2	Short Circuits	30
6.5.3	To set up power districts and sub-districts on your layout:.....	30
6.5.4	How can I be sure I have enough power to run my trains?	30
6.6	Adding a DB150 Booster	30
6.7	Reversing Section Wiring	31
6.8	Using a DB150 as an AutoReversing Booster	32
6.9	Using PM42 for Power Management and AutoReversing.....	33
6.10	Using AR1 for AutoReversing	33
6.11	Using DC and DCC together on the same layout	33
6.12	Troubleshooting Layout Wiring	34
7.0	DCS100/200 Control Panel	35
7.0.1	DCS100 and DCS200	35
7.1	Power On Indicator	35
7.2	Power In Terminals	35
7.2.1	Power Supply	35
7.3	PROG A and PROG B Terminals.....	36
7.4	Ground Terminal	36
7.5	RAIL B and RAIL A Terminals	36
7.6	TRACK STATUS Indicator.....	37
7.7	LocoNet Jacks A and B	37
7.8	SCALE Switch (O/G, N, HO)	37
7.8.1	Track Voltage Adjustment.....	37
7.9	MODE Switch	38
7.10	OFF LINE Indicator.....	38
7.10.1	Heat Dissipation.....	38
7.10.2	Troubleshooting DCS100 Shutdowns.....	38
7.11	CONFIG Indicator.....	38
7.12	NET Indicator	39
7.13	DCS100 Audible Sounds.....	40
8.0	DCS100 CMOS Battery Replacement	41
9.0	Customizing Your DCS100/200--Option Switch Setup ..	42
9.1	Changing DCS100/200 Option Switches.....	42
9.2	DCS Option Switch Tables	43
10.0	DT402 Series Throttle Control Panel	48
10.1	General Information	48
10.2	L (Left) and R (Right) Throttle Knobs.....	48
10.3	Liquid Crystal Display (LCD)	49
10.3.1	Loco Icon	49
10.3.2	Direction Indicators	49
10.3.4	Smoke Icon	49
10.3.4	Mode Indicator.....	50
10.3.5	Text Area.....	51
10.3.6	L (Left) and R (Right) Throttle Display	52
10.3.7	L and R Bar Graph.....	52

10.3.8	Function Display	53
10.3.9	Track Power Indicator	53
10.3.10	Tetherless Indicator	53
10.3.11	L and R Semaphores-Cab Signaling	53
10.4	DT402 Keypad	54
10.4.1	FUNC Key	54
10.4.2	MU Key	54
10.4.3	LOCO Key	54
10.4.4	SWCH Key	54
10.4.5	L and R Reverse Keys	54
10.4.6	Y / + and N / - Keys	55
10.4.7	DISP Key	55
10.4.8	PROG Key	55
10.4.9	EDIT Key	55
10.4.10	FIND Key	55
10.4.11	BACK Key	55
10.4.12	PWR Key	56
10.4.13	OPTN / t Key	56
10.4.14	CLOC / c Key	56
10.4.15	EXIT Key	56
10.4.16	ENTER Key	56
10.4.17	EMRG STOP Key	56
10.4.18	Full Numeric Keypad	57
10.4.19	Infrared Emitters	57
11.0	How to Select and Run Trains	58
11.1	Turn track power on and off	58
11.2	Select and Run An Analog Loco on Address “00”	59
11.3	Select and Run A Decoder-Equipped Loco	60
11.4	Releasing An Address From A Throttle	62
11.5	Dispatching addresses or consists	62
11.6	Recall a Loco	63
11.7	Stealing: Forcing An Address Selection	63
11.8	Slot Following	64
11.9	“slot=max” Message	64
12.0	Stop	65
12.1	Setting A Loco to Zero Speed	65
12.2	Emergency Stop	65
12.2.1	Local Stop-Factory Default	65
12.2.2	Global Stop-Optional Setting	65
12.2.3	Track Power Off Stop	65
13.0	Controlling Functions	66
13.1	Controlling Functions F0-F12	66
13.2	Controlling Expanded Functions F13-F19	67
13.3	Controlling Functions 20-28	68

13.4	Controlling Functions On Consisted Locomotives	68
14.0	Tetherless Operation	69
14.1	General Tetherless Operations.....	69
14.1.1	Selecting a Locomotive-Safety Selection.....	69
14.1.2	Releasing a Locomotive Using IR or Simplex Radio	69
14.1.3	Multiple Unit Operations.....	70
14.1.4	Programming while tetherless	70
14.1.5	Switch Mode.....	70
14.1.6	Ballistic Tracking.....	70
14.1.7	Fast Clock	70
14.1.8	Throttle Keypad Lock	70
14.2	Using the DT402 Series Throttle in IR Mode.....	71
14.2.1	LocoNet ID Change.....	72
14.2.2	Adding a new UR90, UR91 or UR92 to LocoNet	72
14.3	Using the DT402R in Simplex Radio Mode	73
14.4	Using the DT402D Throttle in Duplex Radio Mode	74
14.4.1	Join a Duplex Group when operating in Duplex Radio Mode.....	74
14.4.2	Configuring the Duplex Group name.....	75
14.4.3	Configuring the Duplex Group Channel (11-26)	76
14.4.4	Configuring the Duplex Group Password	76
15.0	Advanced Operations Capabilities	77
15.1	Multiple Unit Operations	77
15.1.1	Adding a Locomotive To A Consist.....	77
15.1.2	Removing A Loco From A Consist.....	79
15.1.3	Nested Consisting	79
15.1.4	MU of Mismatched Locomotives.....	79
15.2	Sw (Switch) Mode	80
15.2.1	To change the position of a switch or turnout	80
15.3	Fast Clock.....	81
15.3.1	Fast Clock Basics.....	81
15.3.2	Stop the Fast Clock.....	82
15.3.3	Edit Fast Clock Time, Rate and Alarm.....	82
15.4	Route Basics	83
15.4.1	Enabling Routes	83
15.4.2	External Routes.....	83
15.4.3	Edit Routes	84
15.5	FIND Key and Digitrax Transponding.....	86
16.0	Customizing Your Throttle - Step-by-Step	87
16.1	Changing the Throttle Options.....	87
17.0	Programming Configuration Variables (CVs)	90
17.1	Programming Mobile Decoder Addresses	91
17.2	Programming CVs Other Than Addresses	93
17.3	Operations Mode Programming.....	94
17.4	Busy or Fail Message.....	95

17.5 Reading Back CV Values Programmed	96
18.0 How the DCS100 Manages Addresses	97
18.1 Purging of addresses:.....	97
19.0 Decoder Status	98
19.1 Status Editing a Decoder	98
19.2 Note for Non-Digitrax Decoder Users	99
20.0 UR92 Additional Information	99
19.1 Advanced UR92 Installation and Customization	99
19.2 Troubleshooting UR92 Installation	100
19.3 Resetting UR92 To Factory Defaults	101
21.0 Troubleshooting Problems	101
21.1 I'm lost!	101
21.2 Runaway train or layout!.....	102
21.3 Nothing is responding	102
21.4 Can't select a loco on my throttle	102
21.5 Clean Track.....	102
21.6 The Quarter Trick	102
21.7 The LT1 Tester.....	102
21.8 Decoder Won't Respond.....	103
21.9 "Strange" Locomotive Lights.....	103
Glossary	104
FCC Information	114
For Canadian Users:.....	114
FCC Information for RF24 module	114
Warranty and Repair Information	115

1.0 Super Chief Xtra Quick Start Guide

These instructions will get you up and running in just a few minutes! A full description of all controls and technical reference information are included later in this manual. This section assumes that you are using a new set straight out of the box. If your set is duplex equipped, we recommend that you follow this quick start guide without using duplex radio to learn the basics. When you are successfully running your duplex throttle tethered to the system, then continue with the Quick Start Duplex section that follows to learn how to operate in the Duplex Radio mode.

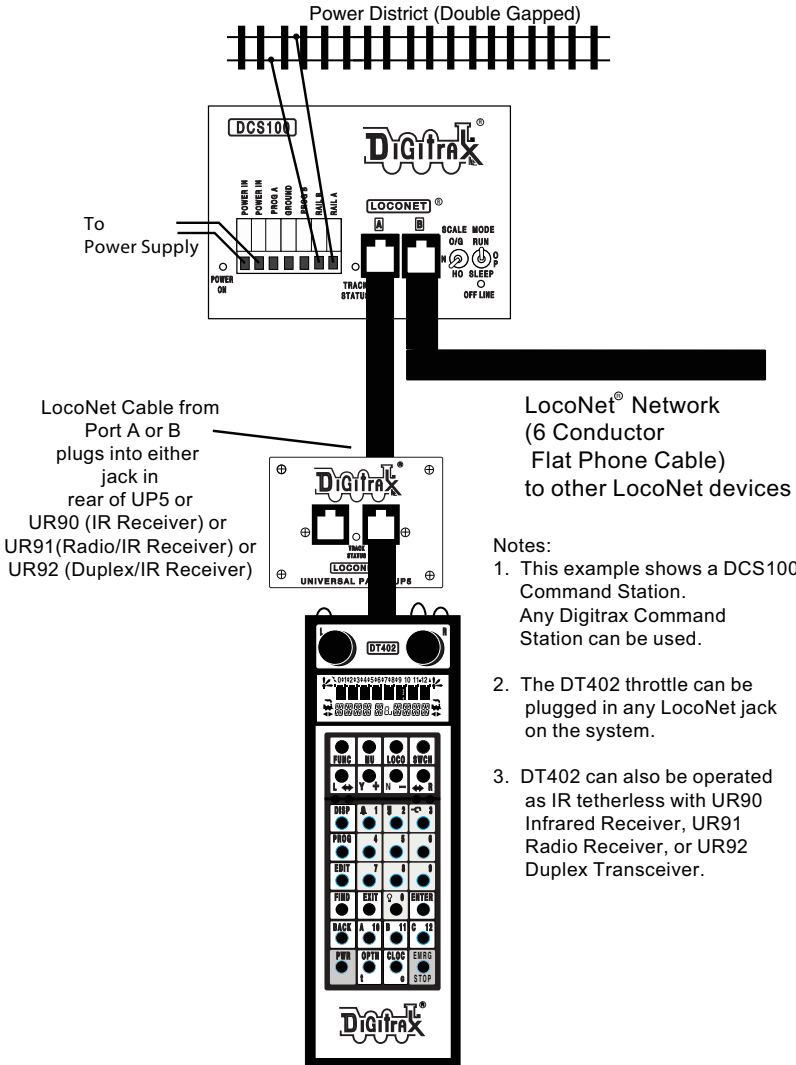

Super Chief Xtra Quick Start Hook Up

1.1 Connect the DCS100 to the power supply

1. Set the DCS100's SCALE switch to the scale you are running: N, HO, O/G. Use the lowest setting (N, HO, or O/G) that will run your layout.
2. Set the MODE switch on the DCS100 to the RUN position.
3. Connect the two terminals on the DCS100 marked POWER IN to the power supply.
4. Plug in the power supply to power up your booster.
5. DCS100 will beep once and its "POWER ON" LED will come on.

1.2 Connect Your DT402 Series Throttle to the DCS100

1. Plug the DT402 series throttle into the LocoNet "A" jack on your Digitrax Command Station. Make sure the power supply is connected to the command station.
2. Press the **PWR** key then the **N / -** key on your DT402 throttle. The TRACK STATUS LED on the command station should be off.
3. Press the **Y / +** key on your DT402 throttle. The TRACK STATUS LED should come on.
4. Turn the **R** Throttle Knob of the DT402 about 1/4 turn. You should see the right side "SEL" in the display begin to blink.
5. Press the **LOCO** key, then the **LAMP/0** key, then the **LOCO** key. You should see "00" replace the blinking "SEL".
6. Turn the **R** Throttle Knob clockwise to "99".
7. Press the **REVERSE / R** key and look for a change in brightness (or color) of the TRACK STATUS LED on the command station. Turn **R** Throttle Knob counterclockwise to "00".
8. Connect the RAIL A and RAIL B terminals from your Command Station to your track and place an analog locomotive on the track. The loco should "sing". Use the **R** Throttle Knob to control speed and the **REVERSE / R** key to control direction.
9. Place a locomotive with a decoder with a known address on the track. Turn the **L** Throttle Knob. You should see the left side "SEL" in the display begin to blink. Press the **LOCO** key, then the numbers for the address, then the **LOCO** key. The loco address will replace the blinking "SEL".
10. Use the **L** Throttle Knob to control speed and the **L / REVERSE** key to control direction of the decoder equipped loco and the **R** Throttle knob and the **REVERSE / R** key to control the analog locomotive.

ENJOY running your trains!

Note: The information in this manual applies to both the DCS100/DCS200 Command Stations/Boosters unless specifically noted. We will refer to the DCS100 in all instructions, but they apply equally to the DCS200. The DCS100 is a 5 amp booster and the DCS200 is an 8 amp booster.

2.0 Super Chief Xtra Quick Start Duplex Radio Operation

These instructions will get you up and running in duplex radio mode in just a few minutes! A full description of all controls and technical reference information are included later in this manual.

2.1 Install the UR92

The UR92 Duplex Radio Transceiver/IR Receiver is simple to install and begin using on your layout.

1. In most cases a UR92 should be situated near the physical center of your layout. One UR92 will cover approximately a circle of 300 feet across. Some layouts may require additional UR92s for adequate signal coverage.
2. Connect the PS14 DC power supply to the UR92 via the DC power jack on the side of the UR92. Plug the PS14 power supply into a 110V outlet. The green and red LEDs should blink and the red LED should stay on.
3. Connect the UR92 to LocoNet "B" jack of your DCS100 using one of the RJ12 jacks at the rear of the UR92. The red LED will go off and the GREEN "RADIO" LED will wink at a 2-second interval to indicate that it is configured for duplex operation.
4. If your layout has UR91s and or UR90s installed, re-set the LocoNet ID by plugging in any DT402 throttle while holding down the **EDIT** Key. Release the **EDIT** Key. Use the R throttle knob to set the LocoNet ID (00-07) you want to use and press Enter to complete LocoNet ID set up. As simplex and infrared throttles plug in to LocoNet, they will log on to the LocoNet ID automatically and all three technologies will work together

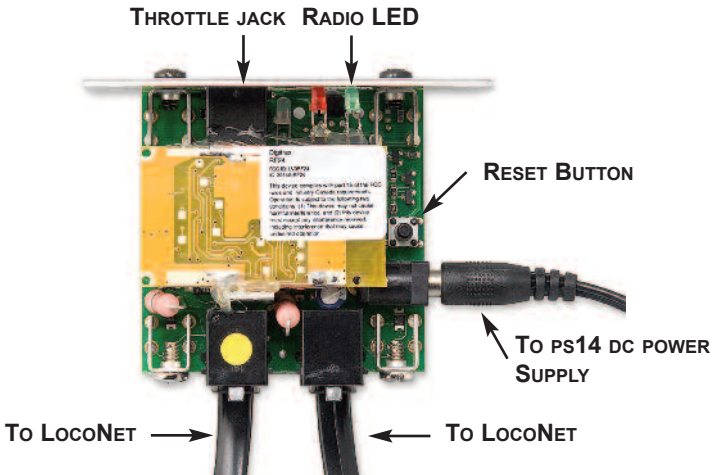

See Section 20 for additional information on UR92 setup and installation.

That is all that is required for UR92 installation! You are now ready to join a Duplex Group with your DT402 Duplex Throttle! See UR92 installation guide for additional information on setup and troubleshooting

2.2 Join Your DT402D Throttle to a Duplex Group

The following ‘plug-in’ method of joining a UR92 Duplex Group is the most convenient and will always work to join any Duplex throttle to a particular UR92 Group. You may also join in wireless mode! *See Section 14.4 for instructions on tetherless operation of the DT402D.*

1. Connect the DT402D Duplex Radio Throttle with a known good battery installed (see following) to the front RJ12 jack of the UR92 until you see the throttle initialize.
2. Disconnect the DT402D from the LocoNet jack. The DT402D will briefly display an 8 character Duplex Group name and the Channel number (#11 through #26) being used by the Group. The Duplex Group name is not important at this point, it is simply used by the DT402D to join this Duplex group on its particular Duplex channel. Note: If your DT402 throttle displays “Idle” at this point, simply plug in to LocoNet again and allow your throttle to re-initialize.
3. The DT402D has now joined the Duplex Group and can be operated as if it were plugged in to LocoNet.
4. Use the DT402D throttle to select one of the locomotives on your system. The UR92’s GREEN **RADIO** LED will blink to show that good duplex messages are being received. If the RF transmissions are not acknowledged by the UR92, the DT402D will blink its white “flashlight” LED to show that there is a duplex radio communication problem. This usually indicates a range or interference issue. (See the UR92 manual for more information on troubleshooting duplex radio issues.)
5. DT402Ds remember the last Duplex Group they joined, even if the batteries are removed, so when re-powered they will automatically rejoin this particular Group if it is within duplex radio range without being plugged in to the system.

You are now ready to run your trains in Duplex Radio mode!

3.0 DT402 Battery Installation

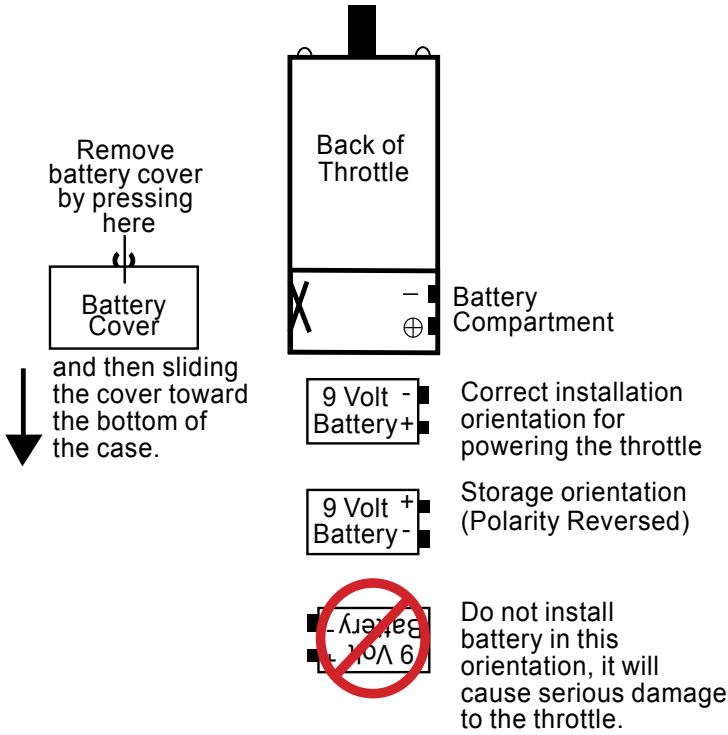

For normal walk around (tethered) operation, the DT402 series throttles do not need a battery. However, when you are unplugged from LocoNet, your throttle display will go off. We recommend using a battery for DT402 operation even though it is not required. To use your DT402/R/D as an infrared or radio throttle, you must install a 9-volt battery. When you install the battery, the throttle will report the battery voltage then show the last display screen used by the throttle.

We recommend that you remove the battery from your throttle if it is unplugged from the system to conserve battery life.

The battery can be stored inside the DT402/R/D by removing the battery and putting it back in the battery compartment with the polarity reversed. See diagram above for proper orientation.

DT402 throttles are shipped with the maximum power save option enabled. To make your batteries last even longer, you may choose to turn off the display backlight. See Section 10.0 for throttle customization options.

4.0 Additional Quick Start Basics

4.1 DT402 Throttle Start Up

1. Plug the DT402 throttle into any throttle jack on a functioning Digitrax LocoNet System or other LocoNet compatible system and you are ready to get started! *See picture in Section 1.0*
2. After you plug the DT402/D into your LocoNet via any throttle jack, you will briefly see the DT402 splash screen:

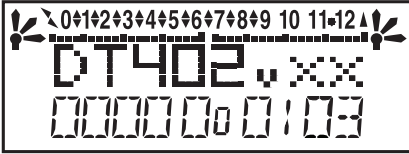

This screen shows the throttle type (v): DT402, DT402R or DT402D and software version number (xx). It is displayed for a few seconds each time you power on the DT402.

3. If you are using a DT402D it will then momentarily display the Duplex Group name and duplex radio Channel.
4. Next you will see the power indicator screen.

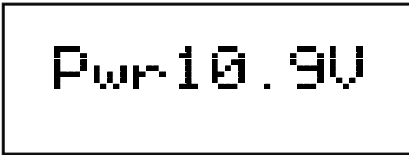

This screen indicates the power available to the throttle. When you are plugged in to LocoNet, this value should be between 9 and 15 volts for proper operation. When you insert a battery or unplug from LocoNet, the value displayed shows the battery power available. When this number is less than 6.2 volts it's time to replace the battery. *See Section 3.0 for more information about installing/replacing the batteries in your DT402.*

5. Then you will see a screen similar to the following.

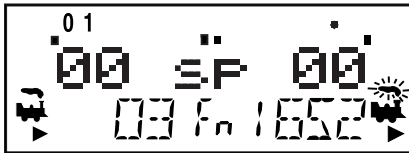

This screen displays current addresses selected on the L and R throttles along with their current speed and direction. The functions that are turned ON for the active throttle (the one with the blinking smoke icon) are displayed across the top of the display.

6. If you unplug the DT402/D from LocoNet the display backlight will go off while it is unplugged. It will come on again when you plug in to LocoNet again.

4.2 DT402 Series Throttle Keyboard Layout

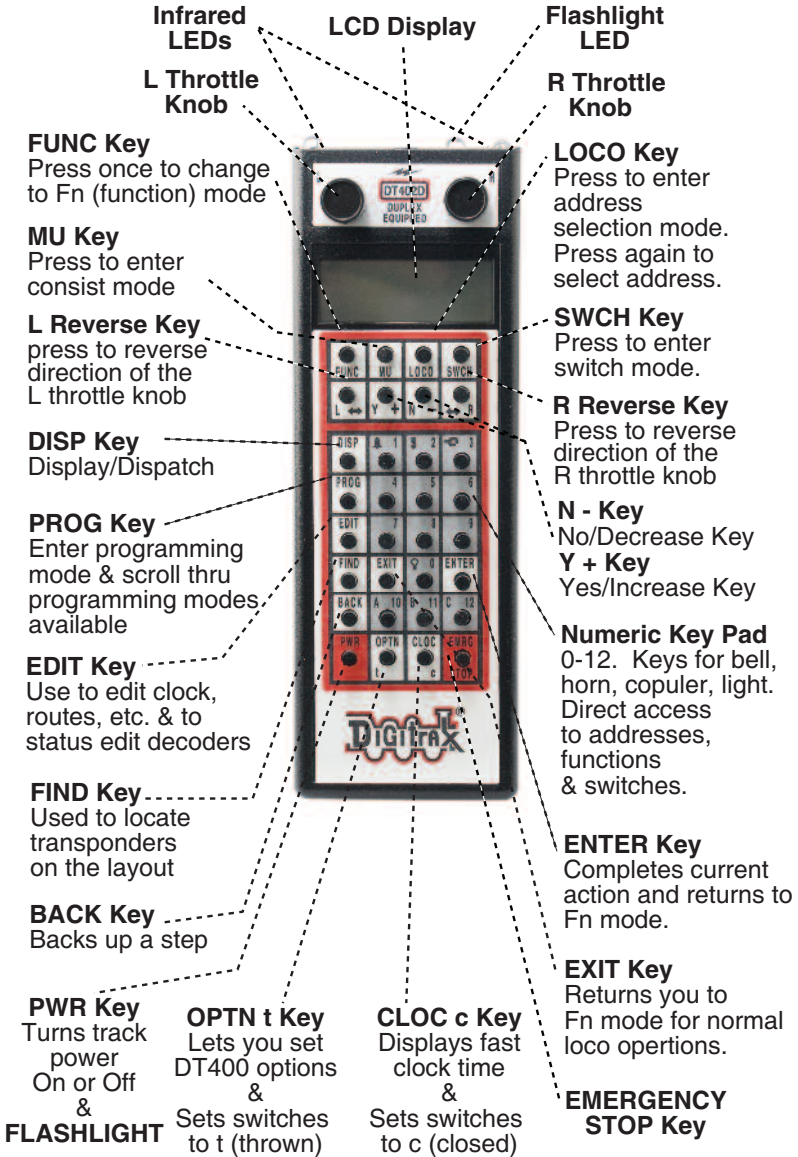

Remember, the EXIT Key will take you back to the Fn Mode for Normal Loco Operations.

4.3 DT402 Series Throttle Controls At A Glance

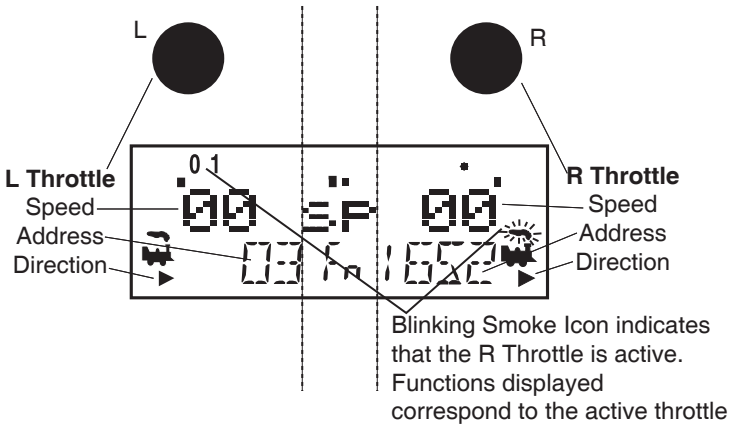

1. The DT402 handheld has two knobs called the **L** Throttle (Left) and the **R** Throttle (Right). The throttles are used for speed control, direction changes, and input of information for operation of your railroad.
2. The row of numbers (0-12) across the top of the display are the functions being used by the active locomotive throttle.
3. The larger numbers in the middle of the screen indicate the speed of the locomotives being controlled by the throttles.
4. The numbers at the bottom of the display are the locomotive addresses, and correspond to the digital decoder that is in each locomotive.
5. There are two locomotives located in the lower corners of the display, one for the **L** Throttle and one for the **R** Throttle. Blinking smoke above the locomotive indicates which throttle is currently active.
6. There are Direction Indicators (arrow heads) located under each locomotive which indicate the direction of travel for each locomotive. The arrows indicate whether the locomotive is moving forward or reverse, not the direction of travel on the track.
7. The function numbers and text information displayed on the display screen is for the active throttle. Keypad entries control functions for the active throttle.
8. The current mode of operation is shown in center of the bottom line of the display. The normal operating mode is Fn or Function Mode for running trains. In this mode, the throttle knobs and direction keys control the speed and direction of the locos. The **Y / +** and **N / -** keys can also be used to increase or decrease speed. The numeric keypad is used for direct access to functions.

4.4 Track power on and off

The TRACK POWER indicator on your DT402/D and TRACK STATUS indicator on your DCS100 command station show whether track power is on or off. The first time you plug in your throttle, track power will usually be off. Before you can run trains, you will need to turn on the track power. Look at your DCS100 or DT402/D to determine whether the track power is on or off.

When track power is off:

- DCS100 TRACK STATUS indicator is off,
- DCS100 OFF LINE indicator is on, and
- DT402 TRACK POWER Indicator is off (TRACK POWER indicator is a small dot in the top line on the right side of the display).

When track power is on

- DCS100 TRACK STATUS indicator is lit,
- DCS100 OFF LINE indicator is off, and
- DT402's TRACK POWER Indicator is on (small dot in the top line on the right side of the display).

Turn track power on and off

1. Press the **PWR** key on the DT402. You will see a screen similar to the one below. You will now be able to toggle the track power on/off:



This display shows a DT402 in PWR mode.

2. Press the **N / -** key to toggle the track power off. The TRACK POWER Indicator on your DT402 and on your Command Station will go off.
3. Press the **Y / +** key to toggle the track power on. The TRACK POWER Indicator on your DT402 display and the TRACK STATUS LED on your Command Station will come on solid.
4. Press the **PWR** key again to return the DT402 to the operating mode.
5. If the TRACK POWER Indicator is blinking and the display shows Trk=Idle then the layout is frozen in the "IDLE" state and no locomotives will move. To exit this state simply turn on track power again.

NOTE: To be sure that the signal is available everywhere on the layout, use a screwdriver blade or a coin across the rails to cause a short circuit. You will hear the 4 beeps and the DCS100 will shut down. Remove the short and the DCS100 will beep once and resume normal operation.

Since the control signal travels with the power on the rails, it is important to have power to the track in all locations so that the decoders can see the signal and respond to your commands.

4.5 Select and Run An Analog Loco on Address “00”

1. Place an analog locomotive (one without a decoder) on your layout. While the analog loco is sitting still, you will hear the characteristic “singing” caused by the DCC track signal when it is applied to analog locomotives. Once the analog loco is moving, this sound will change and be less noticeable. (Analog locos should not be left sitting on DCC powered track for long periods of time when they are not running.)
2. Check the TRACK POWER Indicator is steady on your DT402’s display and the TRACK STATUS LED on Command Station is lit.
3. Activate the DT402’s **R** Throttle knob by turning it a 1/4 turn in either direction or by pressing the **R** Throttle knob once if there is a current loco address and double click* if SEL appears in the **R** address. If there is a loco address, the **R** Loco Smoke will start flashing. If no loco has been previously selected on this throttle it will flash “SEL”.
4. Press the **LOCO** key then 00 on the keypad. You will see a display similar to this where the Lo and 00 are blinking:



5. Press the **LOCO** key again to select address 00 on the throttle. You can also press the **R** Throttle knob once to select the loco address and return to Fn mode for normal operation.
- Note: The **EXIT** key can be used at any time to return to Fn mode for normal loco operation.
6. Turn the **R** Throttle knob clockwise slowly to increase the speed of the analog locomotive. As the speed increases, the locomotive on the track will begin to move. Your command station’s TRACK STATUS indicator should change color as you change the speed setting.
 7. Press the **REVERSE / R** key on the right side of the DT402 or double click the **R** Throttle knob to reverse the direction of the analog loco. The **R** Direction Indicator will toggle between the left and right arrows. In the case of the analog loco, the indicator only indicates a change in track polarity and a change in the physical direction of the locomotive-NOT THE ANALOG LOCO’S ACTUAL FORWARD OR REVERSE DIRECTION OF TRAVEL.

* To double click the throttle knob, quickly press down on the throttle knob twice within about 1/2 second. You will hear a click each time you press down on the throttle knob.

4.6 Select and Run A Decoder Equipped Loco

Each decoder has an address. To select a decoder equipped locomotive and run it on a throttle, you must know its address. Digitrax decoders are set up at the factory with the “default” 03. This means that when you take a Digitrax decoder out of the package and install it in your loco, you can select address 03 on your throttle and run the decoder. The first Configuration Variable (CV) programmed by most users is the decoder’s address since it is not very useful to have all of your locos run on address “03.”

If you do not know the address of the decoder equipped locomotive you want to run, you can simply program the decoder’s address and select it to run using the new, known address. With the DCS100 it is possible to read back the decoder’s address. *See Section 17.5.*

1. Place a decoder equipped locomotive on your layout.
2. Check the TRACK POWER indicator is steady on your DT402’s display and the Command Station TRACK STATUS LED is lit.
3. Activate the DT402’s **L** Throttle knob by turning it a 1/4 turn in either direction or by pressing the **L** Throttle knob once if there is a current loco address and double click if SEL appears in the **L** address. If there is a loco address, the **L** Loco Smoke will start flashing. If no loco has been previously selected on this throttle it will flash “SEL”.
4. Press the **LOCO** key. The left side of the display will begin flashing. You will see a display similar to this:

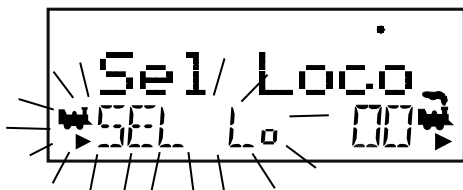

5. Use the numeric keypad to enter 03 or use the **R** Throttle knob to select Address “03” in the left side of the display. (The **R** Throttle knob changes 1s and 10s, the **L** Throttle knob changes 100s and 1000s.)

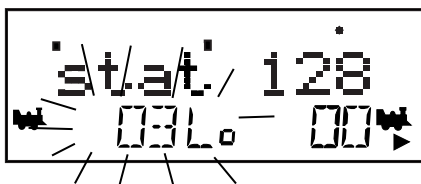

6. Press the **LOCO** key again to select address 03 on the throttle. You can also press the **L** Throttle knob once to select the loco address and return to Fn mode for normal operation.

The illustration below shows the display after address “00” is selected on the **R** Throttle and address “03” is selected on the **L** Throttle, We see the TRACK POWER Indicator On in the top line, the speed bar graphs at 0 speed and the text area also at 0 speed for both throttles.

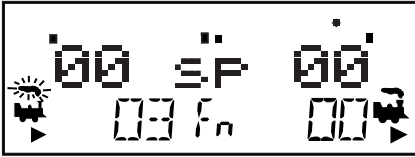

7. Turn the **L** Throttle knob clockwise slowly to increase the speed of the decoder equipped locomotive. As the value in the left display increases, the decoder equipped locomotive on the track will begin to move.
8. Press the **L / REVERSE** key on the left side of the DT402 or double click the **L** Throttle knob to reverse the direction of the loco. The **L** Direction Indicator under the loco icon will toggle between the left and right arrows. In the case of the decoder equipped loco, the arrow indicates locomotive direction (forward or reverse), not the direction of travel on the track.
9. Use the **R** Throttle knob and **REVERSE / R** key to control the analog loco and the **L** Throttle knob and **L / REVERSE** key to control the decoder equipped loco. You can control both at the same time.

Throttle in normal operations mode indicated by Fn.
 In Function (Fn) Mode
 Throttle knobs control Loco's Speed & Direction
 Keypad entries control functions

Track Power Indicator ON

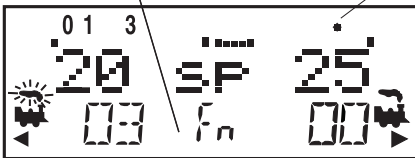

2 digit address 03
 Selected on the
L Throttle
 Running at 20% speed
 In reverse
 Function 0, 1, & 3 on.

An analog loco address 00
 Selected on the
R Throttle
 Running at 25% speed
 The direction arrow below
 the Loco icon **does not**
 indicate actual direction
 for Analog locos.

Notice as you use each throttle knob or direction key that the loco with the “blinking smoke” will change to that side of the throttle. The side with the “blinking smoke” indicator is the active throttle. To control the headlight or other functions, the locomotive must be on the active throttle.

4.7 Shutting Down the System

When you are finished with your session, shut down the Super Chief Xtra by turning off power to the system.

Some users prefer to “dispatch” or release all addresses active in their system before shutting down. This can prevent unexpected results when you power up the layout again. *The dispatch procedure is covered in detail in Section 11.5.*

1. Press the **PWR** key followed by the **N / -** key, the TRACK POWER Indicator on the DT402 and the TRACK STATUS Indicator on your DCS100 command station will go off.
2. Move the command station’s MODE switch to the SLEEP position .
3. Turn off the power supply to the system.

The power to the command station can be left on all the time if desired. In “sleep” mode, the command station consumes very little energy. In this state the command station provides keep alive power to all throttles that are connected to LocoNet.

4.8 Resuming your session

When you are ready to resume your session:

1. Turn on the power to the system.
2. Be sure the DCS100’s MODE switch is in the “RUN” position. All attached throttles will beep within a couple of seconds to indicate that LocoNet is active again.
3. Check the TRACK STATUS indicator on the DCS100. If it is not lit then turn track power on as follows: Press the **PWR** key followed by the **Y / +** key, the TRACK POWER Indicator on the DT402 and the TRACK STATUS Indicator on your command station will come on.

4.9 Quick Start Problems?

If you encountered problems at any step in this Quick Start Section:

First, try backing up a step until you get results described. The steps included in this installation procedure are set up so that if you follow them carefully, any problems you encounter will be easy to isolate and correct.

If that does not work or if you have other questions or problems, we encourage you to call, fax or e-mail Digitrax or your favorite dealer. The Digitrax Tech Support Depot is always available at www.digitrax.com/help

There are thousands of successful Digitrax installations around the world and we want to be sure that yours is one of them.

QUICK INSTALLATION Notes for users of Digitrax decoders that have already been programmed and decoders not made by Digitrax:

1. The DCS100 command station defaults to 128 speed step operation so, if you are using a locomotive with a decoder that does not have 128 step capability you will have to adjust either the decoder or the DCS100 command station so that both are using the same number of speed steps to communicate. You can status edit each individual decoder (*see Section 19*) or you can change the DCS100's system default and run all of your decoders with fewer speed steps to accommodate these decoders (*see Section 9.0*).
2. If you can't control the operation of the lights in your decoder equipped locomotive with the DT402 (in default 128, or 28 speed step mode), be sure that the decoder itself is programmed in advanced 28 speed step mode. Please refer to *Section 19.1* for corrective measures.

4.10 What's Next?

Now that you have successfully set up your Super Chief Xtra Set, it's time to learn more about the features and options offered by Digitrax Complete Train Control and the LocoNet system. Read the manual and take time to understand and master each topic. Your Super Chief Xtra Set is the gateway to all the possibilities and options offered by Digitrax so the best advice is to take it step by step and don't try to do everything at once. For additional resources check out the Digitrax web site at www.digitrax.com.

5.0 LocoNet: The Digitrax Difference!



5.1 System Architecture

System architecture is the biggest difference among layout control systems. System architecture is the way the components of a control system communicate among themselves. Digitrax LocoNet is a Peer to Peer local area network (LAN) designed specifically for model railroad operation. LocoNet wiring is cost effective, flexible and expandable to accommodate almost anything you want to do with your railroad today and in the future.

The system architecture used for communication within DCC and other control systems is not standardized. Therefore DCC compatibility encompasses only decoders, command stations and boosters but not throttles and other devices. In addition, devices that require feedback and other types of signals that are outside the domain of DCC, such as detection systems and transponding, are not standardized. LocoNet is a hybrid system that incorporates DCC and other technologies to expand the capabilities of your system. Your Digitrax system gives you the best of both worlds with a system that is compatible with today's DCC standards and also goes beyond those standards to deliver enhanced system performance and advanced features that are far beyond the scope of DCC. With Digitrax, it's Complete Train Control!

5.2 Event Driven or Polled?

LocoNet is an event driven network. The command station on LocoNet waits for input from other components before sending commands to the layout. For example, if there are 10 throttles on LocoNet and throttle #1 sends a command, the command station sees it and executes immediately. With a distributed network like LocoNet, new features can be added by simply plugging in new hardware or software. Since LocoNet is a peer to peer network, devices on LocoNet can act independently of the command station, too. Feedback is incorporated in LocoNet's communication scheme so you don't need to wire a separate feedback bus.

Other systems typically use polled buses or "networks." In this case, the command station must "ask" each of the throttles or other devices in turn: "Do you have input for me?" The device must wait for the command station to poll all the devices on the bus before it sends the command. This arrangement can slow down response times and limit the number of devices that can be handled by the system as more and more devices are added. With centralized processing in a master/slave control type system like this, adding new features usually means updating the command station software when new components are added since devices can't operate on the system unless the master command station knows how to handle them. To add feedback capabilities to this type of system, a separate feedback bus may also be necessary.

5.3 Network Speed

Is faster network speed better? Not necessarily, it depends on whether the system uses event driven or polled architecture. The NMRA's track control packet format sets the "speed limit" for all DCC systems. Going faster than the "speed limit" won't make a system work any better and causes problems on the network.

LocoNet is engineered for the lowest speed that will get the job done. Because LocoNet is event driven, slower network speeds are possible. With slower network speed, signal distortion on the network is not a problem. Because LocoNet uses a slower network speed, it's free-form wiring scheme is simple and flexible. With LocoNet you can "branch" or "tee" anywhere in your network wiring and no termination is needed.

Polled systems generally have to go a lot faster than the "speed limit" to accommodate the large amount of traffic generated by polling and to prevent delays between the time a command is issued by the throttle and the time the system executes the command. The big problem is that as the network speed increases, so does signal distortion. Polled systems generally use linear terminated bus wiring to solve this problem. Free-form wiring like LocoNet is not usually possible with polled systems.

5.4 LocoNet Personal Edition

LocoNet Personal Edition is available to all model railroaders through our web site. This edition of LocoNet is available so that you can develop your own personal LocoNet applications.

5.5 LocoNet Expansion

The following figure shows some of the expansion possibilities available with LocoNet. This figure is an extension of the Super Empire Builder Xtra in Section 1.0. With LocoNet you can add:

- More boosters to give you more power to let you run more trains,
- More throttles for more operators,
- Different types of throttles,
- More throttle jacks for convenient walkaround operation,
- Infrared or radio capability for more freedom for operators,
- Accessory decoders for turnout and accessory control,
- Detection,
- Transponding,
- Signaling,
- A personal computer to automate operations or for dispatching,
- Automatic reversing with a booster or power manager,
- The list goes on and on.

With LocoNet, you customize your layout to run the way you want it to run!

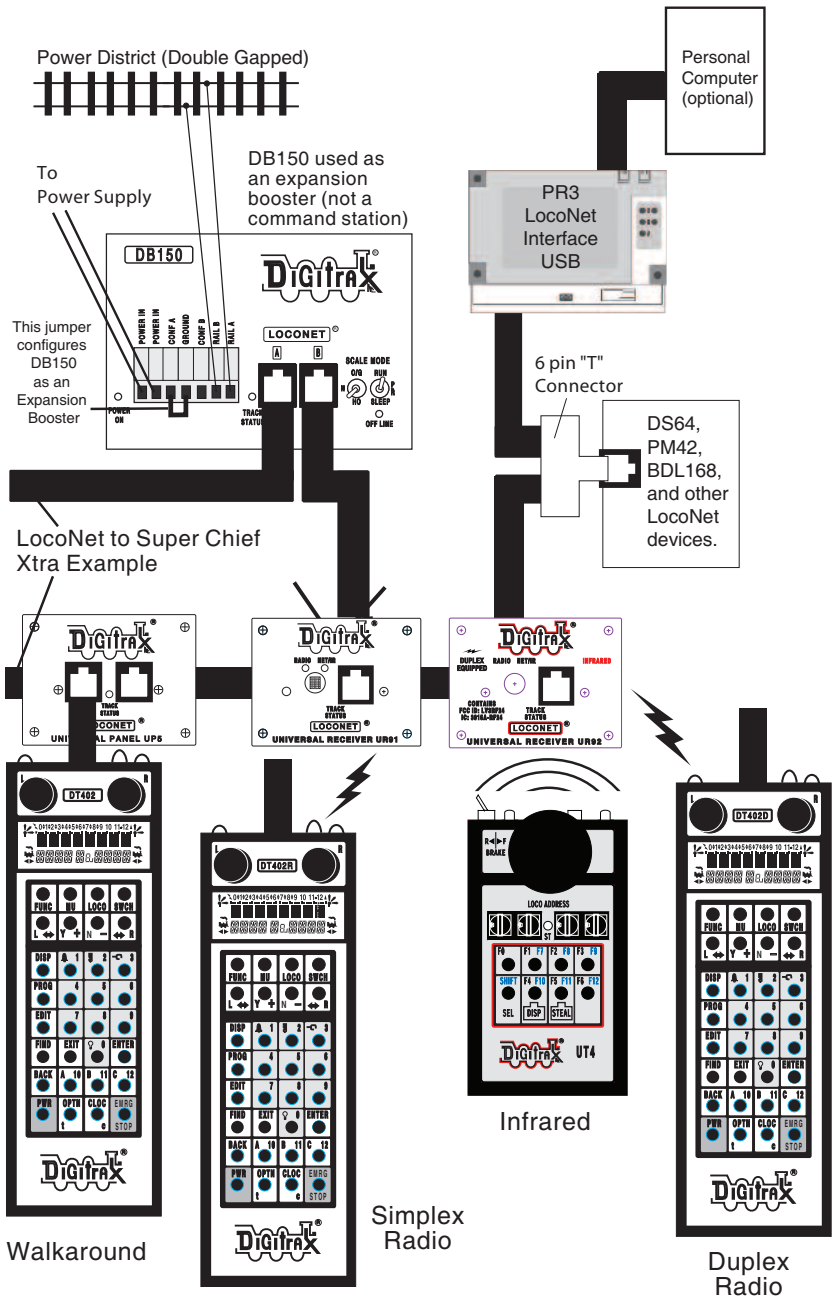

5.6 LocoNet Wiring Components

Connecting the LocoNet components is easy to do. Digitrax LocoNet devices are connected using 6-conductor cables with RJ12, 6-pin connectors.

Making your own LocoNet Cables is simple and cost effective. We recommend that you invest in a good quality set of crimpers. Most Digitrax dealers can supply or tell you where you can get the cable, plugs and crimpers you will need. Internet electronic suppliers also have these components available.

We recommend that you use the LT1 tester that came with your Super Chief Xtra Set to test the cables to be certain they are good before installing them. Many layout problems we see are related to LocoNet cables that were not built or crimped correctly.

LocoNet can support a total cable length of up to 2,000 feet with no two devices connected by more than 600 feet of cable. LocoNet wiring is totally free-form. We do not recommend looping LocoNet back on itself.

5.7 Making LocoNet Cables

We use the following wiring convention for all LocoNet cables and connections:

PIN #	WIRE COLOR	NAME
1	White	Rail Sync
2	Black	Ground
3	Red	LocoNet
4	Green	LocoNet
5	Yellow	Ground
6	Blue	Rail Sync

LocoNet cables are wired pin 1 to pin 1. When you hold the plug with the tab up and look into the end of the connector you will see the wires listed above starting at the left side and moving to the right. (This is sometimes called a “reversing cable” in the telecom industry even though it really does not reverse.)



5.8 Testing LocoNet Cables with an LT1

1. Disconnect the wire harness from the LT1.
2. Plug one end of the LocoNet cable being tested into the LT1.
3. Connect the other end to any powered Digitrax booster LocoNet Jack A or B. Be sure you have at least one Digitrax throttle connected to LocoNet.
4. All four LEDs on the LT1 will light if the cable is good. LEDs may not all

be the same brightness, this is normal.

NOTE: Only three LEDs will light if no LocoNet throttle is plugged in to the system.

5. If any of the LEDs fail to light, recrimp the plugs on the LocoNet cable and retest.

5.9 LocoNet Throttle Jacks and LocoNet Connection Jacks

Digitrax LocoNet devices are connected using 6-conductor LocoNet cables. All LocoNet devices have LocoNet Connection Jacks that allow you to daisy chain the network around the layout.

Some Digitrax devices like the Universal Panels also have LocoNet Throttle Jacks. The Throttle Jacks should not be used for connecting LocoNet devices that will be daisy chained beyond themselves or that use rail sync. You can use these jacks for throttles, DS64s and PM42s. Consult the installation instructions for the particular device you are installing to determine whether it can use the Throttle jacks or if a Connection jack is necessary.

All Digitrax throttles are memory walkaround throttles, some are equipped with infrared LEDs and others are radio throttles. Even if you use wireless throttles, you will still need to install at least one or two LocoNet throttle jacks on your layout. Any RJ12 6 conductor phone jack can serve as a LocoNet throttle jack. The problem with using RJ12 telephone style jacks is that you will have to wire them and secure them to the layout so that they don't come loose.

5.10 Installing the Universal Panel (UP5)

The Digitrax Universal Panel UP5 or UR92, included with your Super Chief Xtra Starter Set, provides a simple plug and play alternative to wiring RJ12 telephone style jacks around the layout. This fascia mounted panel provides 2 RJ12 LocoNet throttle jacks as well as a "TRACK STATUS" indicator on the front panel. The back of the panel provides 2 RJ12 LocoNet connection jacks for daisy chaining to the next LocoNet device on the network. An additional RJ12 throttle jack is provided on the side of the UP5 for connecting additional throttles or LocoNet devices. The panels provide a professionally finished look to your layout fascia. UP5, UR90 (infrared receiver), UR91 (simplex radio receiver) and UR92 (duplex radio transceiver) all provide additional LocoNet Throttle Jacks and Connection Jacks for your system.

UP5 Panel Assembly

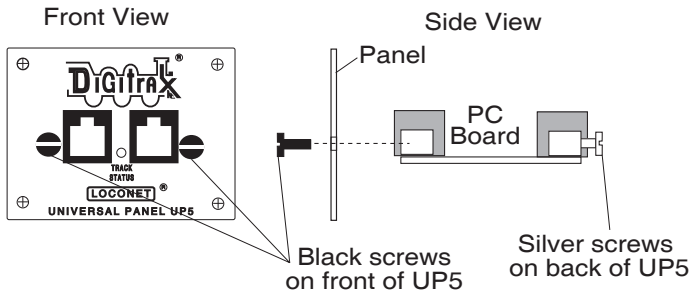

UP5 Assembly and Hook-up

5.10.1 Hooking up the UP/UR's Track Status Indicators (Optional)

The figure below shows how to hook up your UP panel on your layout. Instructions are also included below for hooking up the TRACK STATUS indicator. This is an optional feature and the UPs will work just fine even if you do not hook up the TRACK STATUS indicator to the local track section.

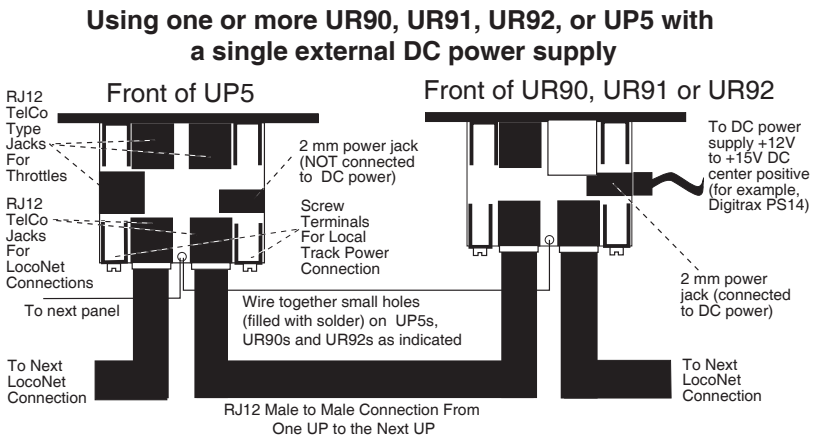

Note: You can run up to 10 UP or UR panels with a single DC power supply by simply connecting the small holes on each panel as indicated in this diagram.

The UP5's, UR90's, UR91's and UR92's TRACK STATUS Indicators are bi-color LEDs that show the status of the local track section to which it is attached. **If you are using track detection, do not hook up TRACK STATUS indicators.** To hook up the TRACK STATUS indicator follow these steps:

1. Attach an 18-26AWG wire to one of the screw terminals on the back of the UP/UR and connect the other end to either rail.
2. Attach another 18-26AWG wire to the other screw terminal on the UP/UR and connect it to the other rail of the track.

3. If you are hooking up more than one UP/UR, be consistent in hooking up all track sections alike with respect to which terminal is connected to which rail. This is not required but strongly recommended.

As you operate your layout, the UP/UR TRACK STATUS Indicator will be lit when the track is powered. The LED glows red or green when you are operating an analog locomotive and the system is "zero stretching." When you are using DCC only, the LED will glow orange. This color change is a useful diagnostic tool.

Now that you have learned more about LocoNet and how to connect the devices using LocoNet cables, let look at installing Digitrax on your layout!

6.0 Advanced Installation of Digitrax On Your Layout

Early proponents of DCC touted the fact that you can hook up your railroad with just two wires. While this is technically correct, there are some things you will need to consider to get the most out of Digitrax Complete Train Control.

Because the signal and the power that runs the trains are one in the same, you must provide adequate power to all areas of your layout for reliable Digitrax operation. ***If the decoder in the locomotive does not see track power, it will not see the signal and it won't run.*** Digitrax boosters need enough track power to sense short circuits to operate properly. Your layout must have a power bus and feeder system that can safely support the continuous full current rating of any booster anywhere on the layout.

The good news is that if your current layout runs with regular DC then it will probably run on Digitrax. Unless you need to set up power districts on your layout for added power, the only gaps you need are for hard shorts like reverse loops and uninsulated frogs. If you are already wired for block control, you probably don't need to rewire. Just open all your blocks so that the entire track has power and you are ready to go. If you are using common rail wiring, we recommend that you divide the layout into power districts by double gapping between power districts.

6.1 Setting Up A Programming Track

Decoders are programmed when the command station sends programming information to them through the rails. There are two ways of programming decoders.

6.1.1 Ops mode programming

Ops mode programming (*see Section 17.3*) is done on the layout with programming directed to a specific decoder address. Operations mode programming is used to make changes other than address to locos while they are running on the layout.

6.1.2 Service mode programming (Using a programming track)

Service mode programming broadcasts a message to all decoder equipped locos that are on the track. Because this is a broadcast method and will affect all locos, you will need to set up a programming track so that the programming instructions only go to the loco you want to program. Decoder addresses can only be programmed using service mode programming. Service mode is also used to program all other Configuration Variables (CVs) as well.

Your DCS100 sends these programming commands using the PROG A and PROG B outputs. See the following figure for hook up information. PROG A and PROG B are actually a second set of outputs that allow you to program decoders while still running the layout on the RAIL A and RAIL B outputs. You will need to set up a programming track for service mode programming that will allow you to program a loco without shutting down the rest of the layout during programming. *Follow the steps outlined in Section 11.3 to program your decoder equipped locomotives.*

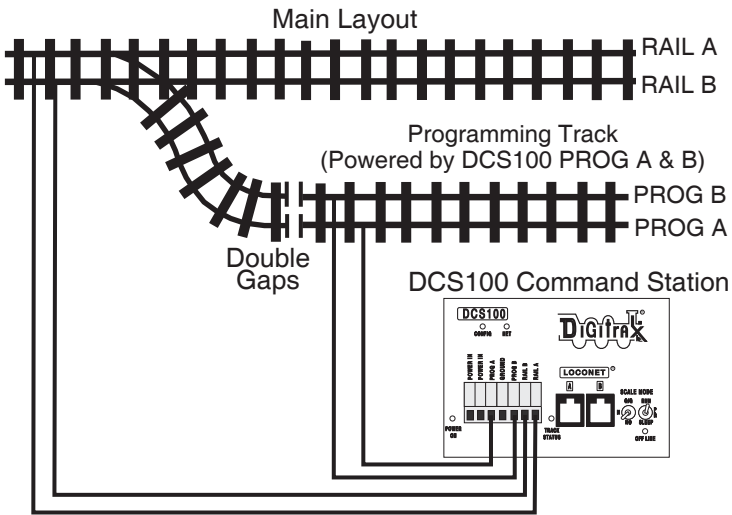

NOTE: Some wiring omitted for clarity

Programming Track With DCS100

6.2 Direct Home Wiring vs. Common Rail Wiring

Digitrax strongly recommends direct home wiring where each power district and its booster are electrically isolated. This type of wiring is safer and more convenient to work with for debugging and for adding reversing sections and detection later. *If you are planning to use whole layout common rail wiring, please have your dealer special order opto-isolated boosters for your layout.*

Note for detection and signaling wiring common rail can be used within power districts that are wired for direct home and use regular Digitrax boosters.

Remember, no matter how you control your trains, you should always use safe wiring practices.

6.3 Recommended wire sizes for power bus and track feeders

On an average size layout Digitrax recommends that the power bus from the booster be at least 16AWG. When feeding areas up to 50' from the booster, we recommend using 12 AWG wire for the power bus.

From the main power bus, we recommend dropping feeders (22-24AWG) approximately every 6 to 10 feet of track. Sets of feeders should be wired to both rails and we recommend at least 2 sets of feeders per power district.

The wire gauges used (AWG) can be increased or decreased, depending on your actual layout dimensions and operating power/current loads.

6.4 Other Track Wiring Considerations

1. Power connections to a large layout should be via a parallel conductor power bus similar to that used in most conventional layouts, with feeder wires to the track about every 6-10 feet.
2. When using more than one booster, be sure that the RAIL A and RAIL B connections for all boosters are made in the same track orientation, i.e. RAIL A to left rail and RAIL B to right rail or vice versa.
3. Do not short either the RAIL A or RAIL B output of the DCS100 to GROUND.
4. To minimize the possibility of radio interference, twist all conductors.
5. Circulating ground loops may cause problems with your layout. We often see this on existing layouts that have been added on to over the years. If you are experiencing problems in a localized area of your layout, you may need to look for this problem and fix it.
6. Wire the power feeds away from the boosters and command stations, in a radial "star like" configuration to minimize the possibility of creating "magnetic induction" loops.
7. **Do not place ANY filters or capacitors across the track.** These will short out the control signals. Be sure that no capacitors are bridging your power districts.

6.5 Layout Power Districts

A power district is an electrically isolated section of the layout including the power wiring, booster and power supply that drives it. Power districts are used for power distribution, not for train control as with DC blocks. Power districts may be divided into sub-districts for short circuit management within the power district or for auto reversing. Even though blocking is not required for

train operation with DC, dividing the layout up into power districts (and sub-districts) is needed for the following reasons:

6.5.1 Number of Locos

Additional power districts may be needed to provide enough power to operate more locomotives than one power supply alone can handle. For example a 5 amp booster and power supply will operate between 10 and 15 average N-scale locomotives and between 6 and 10 HO locomotives. If you wish to run more locos on your layout, then you will need to set up more power districts to provide more total power.

6.5.2 Short Circuits

Additional power districts and sub-districts can be used to prevent the whole layout from shutting down when short circuits (like de-rails or an operator running a switch) occur in any given power district or sub-district. If a short occurs in one district or sub-district, only that area of the layout shuts down, the rest of the layout keeps operating.

6.5.3 To set up power districts and sub-districts on your layout:

1. Determine how you want to arrange power districts and sub-districts.
2. Double gap the rails at each end of the power district and single gap for sub-districts within districts.
3. Connect a DCS100 or other Digitrax booster and power supply to each district. Use a PM42 with your DCS100s to set up sub-districts.
4. Connect the DCS100 or other Digitrax boosters to the command station via LocoNet.

6.5.4 How can I be sure I have enough power to run my trains?

Use the “quarter trick.” Once your Digitrax booster is installed and the layout is powered up, use a quarter (or other piece of conductive material) to short both rails at various places on the layout. If you have enough power at that location, the booster will chirp and shut down. If the booster does not shut down, then you need to add more feeders.

6.6 Adding a DB150 Booster

Your DCS100 is a command station and booster in one unit. The DCS100 is not intended to be used as a booster only. When you are ready to expand your Super Chief Xtra Set, we recommend that you add a DB150 Booster. Be sure that you follow the directions on the following page when you add DB150s to your system so that they are set up to run as boosters. *See Section 6.8 for information about setting up your DB150 as an auto-reversing booster.*

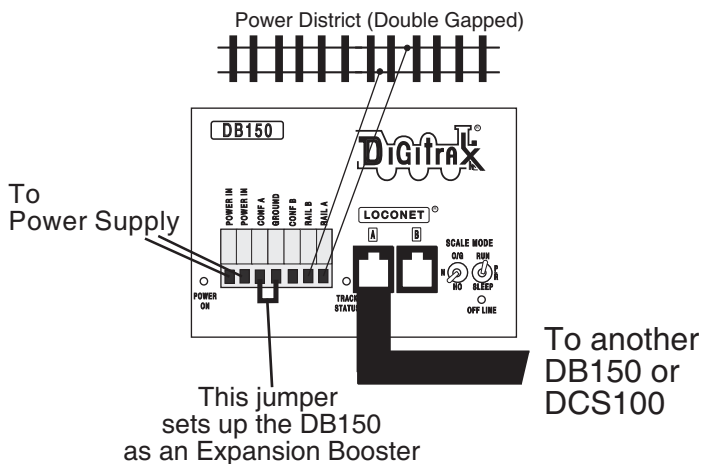

1. Start with an un-powered DB150.
2. Connect the DB150's CONFIG A and GROUND terminals with a short length of wire.
3. Set the DB150's MODE switch to RUN.
4. Power up the DB150. The DB150 will automatically convert to booster only operation when you power it up.
5. Connect the DB150 to your DCS100 on LocoNet via either LocoNet Jack A or B using regular LocoNet Cables that have been tested with the LT1.
6. Use a coin to short one rail across the gap between the booster districts. If there is no short, your installation is correct. If there is a short, swap the Rail A & Rail B wire connections to the district.
7. You can add more DB150s by "daisy chaining" additional DB150 boosters via the LocoNet Jack A or B on any DB150 in the system.

If you experience problems with operation after you add a DB150 to your system, check to be sure that you have actually set it up as a booster by going through the steps above again. We have seen this simple mistake cause operating problems with modular layouts when someone added a DB150 set up as a command station to a layout that was already up and running with another command station (DCS100 or DB150). In this case, two command stations can be trying to run the same layout causing some undesirable operating results such as trains that appear to be running away.

6.7 Reversing Section Wiring

You can operate reversing sections manually or automatically with Digitrax Complete Train Control using an auto-reversing booster, a reversing section controller such as an AR1 or PM42. You must double gap (completely isolate) both ends of the reversing section just like with any other layout. Note that

automatic reversing will not cause analog(non decoder equipped) locos to auto reverse.

If you choose manual operation, use a DPDT switch or relay to handle the polarity change as the loco enters and leaves the reversing section.

If you choose to use a DB150 auto reversing booster to completely automate the reversing section, power the reverse loop with a DB150 and power supply and the main layout with your DCS100 and power supply. The DCS100 when running as your command station will not auto-reverse.

6.8 Using a DB150 as an AutoReversing Booster

1. Start with an un-powered DCS100.
2. Connect the DB150's CONFIG A and GROUND terminals and CONFIG B and GROUND terminals with two short lengths of wire.
3. Set the DB150's MODE switch to RUN.
4. Power up the DB150. The DB150 will automatically convert to automatic reversing booster operation when you power it up.
5. Connect to your DCS100 or other DB150s on LocoNet via either LocoNet Jack A or B using LocoNet Cables that were tested with an LT1.

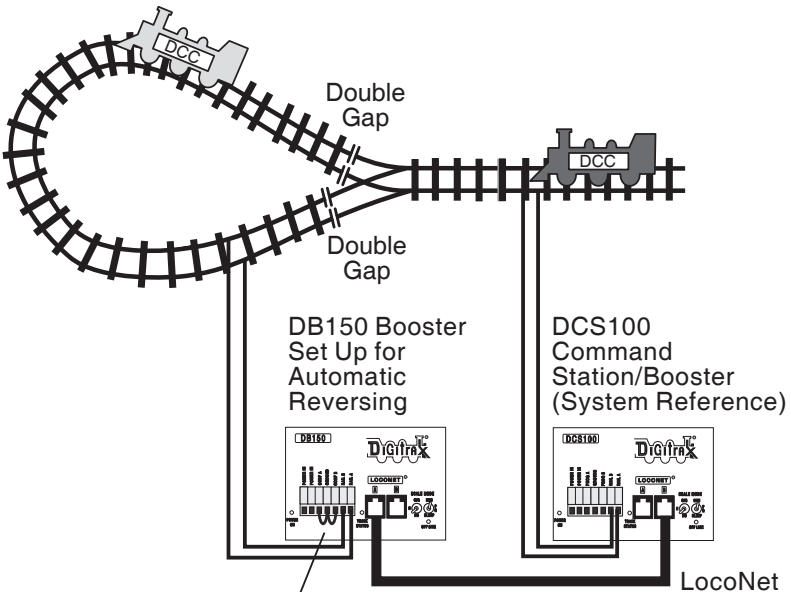

Jumper wires between CONFIG A and GROUND and CONFIG B and GROUND

Note: Some wiring omitted for clarity

Automatic Reversing Section Set-Up

Note that when the polarity change occurs, decoder equipped locomotives will continue at the speed and in the direction commanded but any analog engines running will respond to the polarity change by reversing direction.

To handle auto reversing, you will need two devices, one that acts as the system polarity reference and another to detect a polarity mismatch and correct it. If you are using two Digitrax boosters, one acts as the polarity reference and the other handles the polarity reversal for the reversing section. You can also use a DCS100 and PM42 to handle automatic reversing sections.

A single DB150 can be used to handle more than one reverse section however, the unit can only fix a polarity mis-match at one gap at a time. If more than one train is entering or leaving the reverse loops connected to a single booster at the same time, a short will occur. More than one train can be in the reverse loop at any time but, only one can cross the double gap at a time.

6.9 Using PM42 for Power Management and AutoReversing

If you want the benefits of setting up power districts on your layout but you don't need to add more power to run more trains, you can use a PM42 Quad Power Manager to set up sub-districts within booster power districts. With PM42 you can separate the output of one or more boosters into four sub-districts that can be set up as either auto-reversing or as smart circuit breakers for short circuit management.. For more information about this option, contact your Digitrax dealer or check our web site at www.digitrax.com.

6.10 Using AR1 for AutoReversing

If you have a single reversing section that doesn't need its own booster, you can use the AR1 single unit auto reverser to make it auto-reversing.

6.11 Using DC and DCC together on the same layout

When running between DCC track sections and adjacent conventional DC powered tracks, both rails must have insulating gaps.

The DC supply used must have some form of current control. A 5 to 10 Watt 12 Volt lamp placed in series with one of the DC power pack track leads will work for this purpose. This allows the booster to drive the locomotive onto the DC track with minimum interruption and stress to the booster, decoders and locomotive wheels. When the lamp lights as the locomotive bridges the gaps it acts as a "shock absorber" between the DCC and DC track sections. It is best to cross these gaps quickly and not bridge the DCC and DC sections for any longer than necessary.

Some new Digitrax users believe it is very important to be able to switch between DC and DCC operation as they make the change from DC to DCC. In practice we find that most of these customers make the change much sooner that originally planned because of the operational benefits of Digitrax.

6.12 Troubleshooting Layout Wiring

Installing Digitrax, or any other layout control system, on your layout will not fix problems with layout wiring. Layout wiring can be very complex. We see many examples of layouts that have “grown over the years” where wiring was added and changed creating some very interesting electrical systems. If you suspect that layout wiring might be a problem, we recommend that you disconnect the Digitrax equipment from the layout and test it on a small section of track not connected to the layout to confirm that the problem is not with your Digitrax equipment. If you find that there is a problem with your Digitrax equipment, contact Digitrax tech support. If you find that your Digitrax equipment is working fine, then it is time to de-bug the layout.

Observe the problem carefully and methodically.

Does it occur with both DC and DCC operation?

If so, check track wiring.

Is it occurring everywhere on the layout or in one particular area?

With your Digitrax system hooked up, a coin or screwdriver to short out the track. If no short occurs, you may not have enough feeders or your power supply may not be adequate. Use your LT1 to test the LocoNet cables attached to the booster in the problem area.

Does it only occur with certain locomotives?

Check the locomotives for mechanical problems and for damaged decoders. If you programmed the decoders just before the problem started, re-program them in case you entered values by mistake that are causing the problem.

Does it only occur with certain throttles, boosters or other equipment?

If the problem happens with just one piece of equipment, then you may need to have it repaired. Check the RJ12 jacks to be sure the pins are not misaligned.

Does it occur only when plugged into a certain LocoNet jack?

Check the wiring to that jack, particularly if you are using telco type jacks that you wired yourself. Use your LT1 to test the LocoNet cable you are using in that area of the layout.

Have you recently changed anything in your layout wiring? If so, try disabling the change to see if they layout will run without the “upgrade.” You may need to de-bug the upgraded wiring.

Have you changed any of the DCS100 or DT402 option settings? Try resetting them to the default values and check to see if the layout will run.

Have you recently installed additional boosters on your layout?

If so, check to be certain that these boosters are set up properly as boosters. If more than one command station is operating on your layout, you may experience unexpected operation when the decoders are taking commands from two different sources (command stations.)

When LocoNet is first powered up all Digitrax command stations check for other command stations also operating on LocoNet. The first command station that powers up will become the command station and all others will automatically operate as boosters. If you have two separate operating LocoNets and you connect them with a LocoNet cable, both command stations will continue to operate and operating problems will occur. Modular layouts are at a high risk of encountering this problem if more than one part of the layout is up and running and then those parts are added together. Be sure in this case that you completely power down all operating LocoNets before combining them into one big LocoNet to avoid having more than one command station trying to run the layout.

7.0 DCS100/200 Control Panel

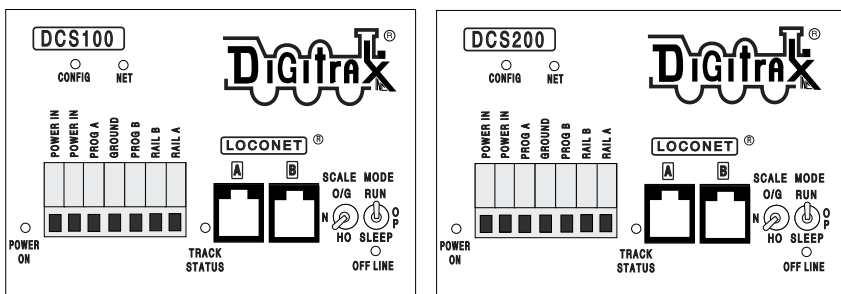

7.0.1 DCS100 and DCS200

The information in this manual applies to both the DCS100/DCS200 Command Stations/Boosters unless specifically noted. We will refer to the DCS100 in all instructions, but they apply equally to the DCS200. The DCS100 is a 5 amp booster and the DCS200 is an 8 amp booster.

7.1 POWER ON Indicator

This green LED indicates that the power to the DCS100 is on.

7.2 POWER IN Terminals

The two POWER IN terminals on all Digitrax boosters and command stations are the power input connections.

7.2.1 Power Supply

Digitrax recommends the PS515 power supply to power all DCS100s and the PS2012 for DCS200s. There are many other power supplies and power packs that can supply the input power for the DCS100. Check with your Digitrax dealer for suggestions. Most regular DC model railroad power packs are not able to supply 5 amps to the DCS100 booster, because they were designed to run only 1 or 2 locomotives in a DC blocked system. With Complete Train Control you'll be running multiple locomotives in the same power district so, you'll need to provide more power to each district.

AC or DC	AC 50/60 Hz	DC
Max Input	20 RMS AC	28V DC
Min Input	12VAC	12V DC
Optimal Input Current	5 Amps	5 Amps

DCS100 Transformer Requirements

AC or DC	AC 50/60 Hz	DC
Max Input	20 RMS AC	28V DC
Min Input	12VAC	12V DC
Optimal Input Current	8 Amps	8 Amps

DCS200 Transformer Requirements

Power to the DCS100 should not be rapidly cycled ON-OFF-ON. When power to the unit is switched off, wait 30 seconds before turning on the power again.

7.3 PROG A and PROG B Terminals

The PROG A and PROG B terminals are the output for the second set of signals which allow you to set up a programming track that can be used while the rest of the layout continues to run.

PROG A and PROG B can also be used to set up braking sections on your layout. This is useful if you want to stop trains at given points on the railroad, for example at a station. Instructions for setting up brake sections can be found on our web site, www.digitrax.com/ftp/brakedist.pdf

7.4 GROUND Terminal

The terminal marked ground provides electrical safety features and an RF ground reference for minimum radiated noise. This should be the ONLY point of any DCS100 installation that is connected to the AC safety ground pin provided on most 3 pin 110V AC power sockets. Grounding the system is a sensible safety precaution that should not be ignored.

7.5 RAIL B and RAIL A Terminals

Connect these terminals to the track on all Digitrax boosters and command stations. If you are using more than one booster, always connect the same rail to the same terminal on each booster, for example connect all RAIL A terminals to the right rail and all RAIL B terminals to the left rail or vice versa on all track sections.

7.6 TRACK STATUS Indicator

The TRACK STATUS indicator shows that there is voltage on RAIL A and RAIL B terminals. The color indicates the type of signal.

- **orange** indicates the track is getting signals with no analog zero stretching.
- **green or red** indicates a “stretched zero” signal is being used to operate a conventional (analog) locomotive. When zero stretching is present, the decoder equipped locomotives will read their digital commands normally and perform as commanded.
- **not lit** indicates there is no voltage on the track, the track power to the DCS100 may be OFF.

7.7 LOCONET Jacks A and B

These jacks let you expand your Digitrax system by simply plugging LocoNet devices in to the system. They can be used for throttles and other LocoNet devices. These jacks are functionally the same and can be used interchangeably.

7.8 SCALE Switch (O/G, N, HO)

This switch sets the maximum track voltage limit.

Scale	Max Track Voltage
O/G	20 volts
N	12 volts
HO	15 volts

7.8.1 Track Voltage Adjustment

The actual track voltage supplied by the DCS100 can be adjusted. To do this, you must open the DCS100 case (this will not void your warranty).

1. Remove the DCS100 input power and disconnect all DCS100 leads. Remove the gray plug from the front of the DCS100
2. Remove the two screws on the top and bottom of each side of the case.
3. Slide the gray front panel off the DCS100.
4. Be careful to avoid disturbing components other than the ones described in the following steps.
5. Locate the small trimmer potentiometer behind the LocoNet Jack B and Scale Switch.
6. Use a small screwdriver to turn the potentiometer clockwise to increase the scale voltage setting. Turn it counter clockwise to decrease the voltage setting.
7. To determine the actual track voltage, measure the DC voltage (unloaded)

from either the RAIL A or RAIL B terminal to the green ground wire on the case. Multiply the measured voltage by 2 to determine the approximate digital track voltage supplied.

7.9 MODE Switch

The MODE switch settings are:

- RUN normal operations.
- OP customize the DCS100 by changing its option switch settings.
- SLEEP shutdown the system and all throttles that are plugged in to the system.

7.10 OFF LINE Indicator

The DCS100 automatically shuts down when the heat sink temperature rises to around 113-122 degrees Fahrenheit (45 to 50 degrees Celsius) and the OFF LINE indicator will glow red. The DCS100 automatically resumes operation when the heat sink cools down to approximately 104 degrees Fahrenheit (40 degrees Celsius).

The OFF LINE indicator will also be lit when there is no TRACK STATUS. This is normal and you should not be alarmed.

7.10.1 Heat Dissipation

It is normal for the DCS100 to be warm to the touch when it is in use. It is designed to absorb and dissipate the power difference between the input voltage and the selected scale output stabilized voltage, at the current load being drawn. If the unit is not able to dissipate excess heat, over temperature thermal shutdown may occur. We recommend that you locate the boosters in a location where they can dissipate heat. If you experience frequent over temperature shutdowns, add a small fan to help cool the booster.

7.10.2 Troubleshooting DCS100 Shutdowns

1. Move the DCS100 so that the heat sink has a flow of cool air.
2. Place the DCS100 out of direct radiant heat like sunshine or a room heater.
3. Try direct cooling by using a small fan to blow air onto the heat sink.
4. Lower the track load current.
5. Reduce the input voltage from the power supply.

If the DCS100 beeps 4 times and shuts down briefly and then comes back on again, it is probably being run too close to its pre-set current limit. In this case it may clip or mutilate some outgoing packets to keep the track current within acceptable limits. To solve this problem, reduce the track current load by setting up additional power districts to provide more total power for the layout.

7.11 CONFIG Indicator

The green CONFIG Indicator shows the primary operating mode of the

DCS100. This indicator should be steady green blinking off briefly once every 4 seconds. This indicates that the setting for DCS100 Option Switch 05 is set up correctly. If you see 8 blinks every 4 seconds then we recommend that you change the DCS100 Option Switch 05 to “closed.” The DCS100 will operate correctly in either case. *See Section 9.0 for information about Option Switches.*

The CONFIG Indicator will be mainly off when DCS100 option switch 01 is incorrectly set to “closed.” In this case you must change option switch 01 to “thrown” for correct operation. *See Section 9.0.*

7.12 NET Indicator

The NET indicator is a red LED that displays information about what the DCS100 sees on LocoNet. When your layout is wired correctly and LocoNet is operating properly, the NET indicator will be on and it will flicker off any time a good LocoNet message is detected by the DCS100. The table below explains the patterns you will see for this indicator.

NET LED Indication	Meaning
Solid Red	LocoNet OK
On, blink off	DCS100 detects a valid LocoNet message
Off	DCS100 detects a short circuit on LocoNet
Off, blink every 1/2 second	DCS100 is in Option Set Up Mode

7.13 DCS100 Audible Sounds

The DCS100 uses several beeps and clicks that can be used as diagnostic tools that help you debug a number of conditions

Sound	Meaning
1 Beep	DCS100 has powered on successfully or has sent a programming command.
3 Beeps	A loco address has been "purged" due to non-use. This is informational only. Refer to the DCS100 Option Set Up Section for information on customizing loco address purging.
4 Beeps	Booster short circuit shutdown. Fault Alarm.
6 Beeps	Command station already present in system. When two command stations are operating on the same system, you may experience unexpected results.
7 Beeps	DCS100 CMOS battery low condition. Battery should be replaced as soon as possible. See Section 8.0 for CMOS battery replacement instructions.
8 Beeps	Memory ECC/checksum fail. This indicates that the local CMOS memory has been corrupted and was reset automatically. This is a technical diagnostic.
9 Beeps	DCS100 transmit failure, there is a device blocking proper message action on LocoNet.
16 Beeps	Software timeout failure. No action is required, the unit will resume operation.
Continuous Soft clicks	Low input power supply voltage. If the DCS100 input voltage falls below about 9.5V DC or 8V AC while operating, the DCS100 will emit a series of continuous soft clicks until the low voltage condition is corrected.

DCS100 AUDIBLE SOUNDS

8.0 DCS100 CMOS Battery Replacement

When you hear 7 beeps when power is applied to your DCS100, you need to replace the CMOS battery. The DCS100 will continue to operate, even if this battery is not present, but all your memory settings and option switch settings will not be remembered when the DCS100 is powered down.

To replace the CMOS battery without losing any memory settings:

1. Remove the DCS100 input power and disconnect all DCS100 leads.
2. Open the DCS100 case:
 - a. Remove the two screws on the top and bottom of each side of the case.
 - b. Remove the gray plug from the front of the DCS100.
 - c. Slide the gray front panel off the DCS100.
3. Locate the empty coin cell holder on the upper PC board at the top left of the unit. There are 2 battery holders and it does not matter which holder has a good battery installed.
4. Slide a new CR2032 style 20mm diameter 3V lithium coin cell in the empty holder with the “+” terminal visible on the top side.
5. Remove the old battery from the other battery holder and discard the battery.
6. Be sure not to short the arm on the top of the battery holder to the metal case or to any PC board connection inside the case.
7. Reassemble the DCS100 case. Be sure not to disturb other components and not to leave any loose parts inside when you put the case back together.
8. Reconnect the DCS100 and listen for the single beep when it comes on. If you hear 7 beeps again, either the battery was not installed correctly or it was not a good battery.

9.0 Customizing Your DCS100/200--Option Switch Setup

The following instructions apply to both the DCS100/DCS200 Command Stations/Boosters. We will refer to the DCS100 in all instructions, but they apply to the DCS200 also. The Option Switch (OpSw) setup allows you to customize the operation of the units to meet your layout and operation. The DCS100's power up defaults are fine for most applications and the DCS100 will run "out of the box." **The factory default setting for all DCS100/200 option switches is "t" or thrown.** We recommend that you change Option Switch OpSw 05 to "c" or closed. This will not affect your operations, it will just make diagnostics easier to do.

The internal battery backed CMOS memory will hold these settings for a year or more in normal usage. When your battery is low, an alarm will sound to let you know that it's time for a new battery. You will be able to "hot" change the battery so that none of your system settings are lost. See previous section for DCS100 CMOS battery information. The power fault/ battery fail "clean restart" for all DCS100 option switches is "t" or thrown.

9.1 Changing DCS100/200 Option Switches

1. See the Option Switch Table below to decide which option switches you want to change.
2. Move the MODE toggle switch on the front of the DCS100 into the "OP" position. The LocoNet Railsync will go inactive and all other boosters plugged in to LocoNet, including the one that is built into the DCS100, will shut down.
3. Disconnect LocoNet from the DCS100 you are configuring.
4. Connect your DT402 throttle directly to either DCS100 LocoNet Jack A or Jack B.
5. Press the **SWCH** key on the DT402 to enter Sw (Switch) mode. Since the DCS100's MODE toggle switch is set to "OP", switch commands from your throttle will now control DCS100 internal option switch settings instead of the accessory decoders (usually turnouts) on the layout!



6. Key in the number of the OpSw. In the example above, we have keyed in 5 for the switch. As you browse through the OpSw's, the right side of the text area will show the current setting for each OpSw , either "c" or "t".

7. Use the **CLOC / c** key to set the OpSw to **c** (closed) or the **OPTN / t** key to set the OpSw to **t** (thrown). In the example above we have changed OpSw 5 from its factory setting of **t** to **c** (recommended setting).
8. Exit DCS100 Option Switch Mode by moving the MODE toggle switch on the DCS100 to “RUN.” Remember to reconnect LocoNet to the DCS100. Track power will be off so you will need to use your DT402 to turn it on again before you can run trains.

Note: Do not adjust any Op Switches marked “Do Not Change” These option switches are reserved and changing them may give unpredictable operations. Do not change any option switches not listed in the table below.

Special Instructions for DCS100 Op Switches 36, 37, 38, and 39

For Op Switch #36-#39 to work properly,

1. Set the OpSw to “**c**” by pressing the **CLOC / c** key.
2. Set the DCS100’s MODE Switch to “SLEEP” mode.
3. Set the DCS100’s MODE Switch back to “RUN” mode.
4. The operation will occur (data will be cleared) and the option switch will reset to “**t**”.
5. Your DT402 display will still show “**c**” even though the reset has occurred.
6. The display will update the next time you access the OpSw.

9.2 DCS Option Switch Tables

The following tables provide a list of the DCS100/200 Option Switches and the impact of the change on the system.

DCS Option Switch Tables

Option Switch #	Effect on System operation when "closed"	Factory Default
OpSw 01	Do Not Change	t
OpSw 02	Do Not Change ("c" setting makes DCS100 a booster)	t
OpSw 03	DCS100's booster is auto reversing	t
OpSw 04	Do Not Change	t
OpSw 05	Command station master mode (We recommend this be changed to c)	t
OpSw 06	Do Not Change	t
OpSw 07	Do Not Change	t
OpSw 08	Do Not Change	t
OpSw 09	Do Not Change	t
OpSw 10	Do Not Change	t
OpSw 11	Do Not Change	t
OpSw 12	Do Not Change	t
OpSw 13	Loco address purge time extended from 200 seconds to 600 seconds	t
OpSw 14	Loco address purging disabled	t
OpSw 15	Purging will force a loco to 0 speed	t
OpSw 16	Do Not Change	t
OpSw 17	Automatic advanced decoder assisted [FX] consists are disabled	t
OpSw 18	Extend DCS100 booster short circuit shutdown time from 1/8th to 1/2 second	t
OpSw 19	Do Not Change	t
OpSw 20	Disable address 00 or analog stretching for conventional locos.	t

DCS100/200 Option Switches

Option Switch #	Effect on System operation when "closed"	Factory Default
OpSw 21	OpSw 21-23 set the global system default type for "NEW" loco selections. SW21/22/23 set as follows: t-t-t = 128 step mode t-t-c = 128 step FX mode c-t-t = 14 step mode c-c-t = 28 step	t
OpSw 22		t
OpSw 23		t
OpSw 24	Do Not Change	t
OpSw 25	Disable aliasing	t
OpSw 26	Enable routes	t
OpSw 27	Disable normal switch commands, a.k.a. the "Bushby bit." Allows attached PC to handle switch control logic	t
OpSw 28	Disable DS54 interrogate commands at power on	t
OpSw 29	Do Not Change	t
OpSw 30	Do Not Change	t
OpSw 31	Meter route/switch output rate when not trinary	t
OpSw 32	Do Not Change	t
OpSw 33	Allow track power to restore to prior state at power on	t
OpSw 34	Allow track to power up to run state, if set to run prior to power on	t
OpSw 35	Do Not Change	t
OpSw 36*	Clears all mobile decoder info & consists	t
OpSw 37*	Clears all routes	t
OpSw 38*	Clears the loco roster	t
OpSw 39*	Clears all internal memory states, including OpSw 36, 37 & 38	t
OpSw 40	Do Not Change	t
OpSw 41	Diagnostic click when valid LocoNet commands incoming & routes being output	t
OpSw 42	Disable 3 beeps when loco address purged	t

* See special instructions in *Section 9.1* for setting OpSw 36-39..

DCS100/200 Option Switches (Continued)

Option Switch #	Effect on System operation when "closed"	Factory Default
OpSw 43	Disable LocoNet update of command station's track status	t
OpSw 44	Expand slot refresh area from 22 (Big Boy compatible) to 120	t
OpSw 45	Disable reply for switch state request	t
OpSw 46	Do Not Change	t
OpSw 47	Program track is brake generator when not programming. Braking is DCC set to speed 0 (not Emergency stop) for address 0, light ON, broadcast to all addresses	t

DCS100/200 Option Switches (Continued)

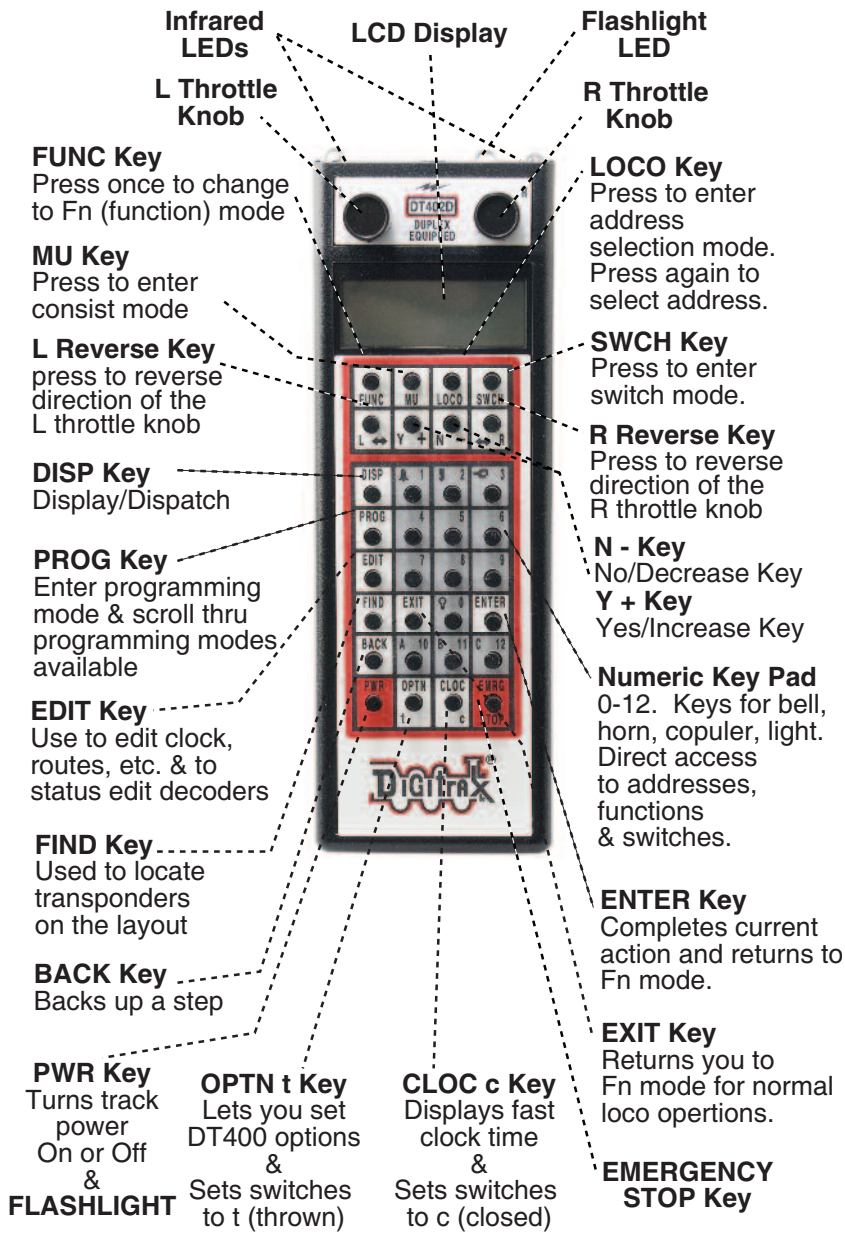

Remember, the EXIT Key will take you back to the Fn Mode for Normal Loco Operations.

10.0 DT402 Series Throttle Control Panel

10.1 General Information

The DT402 series are full function hand held throttles that include 2 independent throttles and a common keypad to control, up to 29 functions (F0-F28), turnouts and programming. The DT402 does not require a battery in normal walkaround operation. If you do not install a battery, the throttle display will be off while you are unplugged from the system. We recommend that you use a battery in all DT402s even when not required. The DT402 requires a known good 9-volt battery for infrared operation. The DT402R and DT402D require a known good 9-volt battery for both infrared and radio operation.

10.2 L (Left) and R (Right) Throttle Knobs

Throughout this manual we refer to the throttle knob on the left side as the **L Throttle** and the throttle knob on the right side as the **R Throttle**. This corresponds to the **L** and **R** that appear on the throttle.

The throttle knobs on the DT402 use “encoders.” They give very smooth, fine speed control. In 128 speed step mode it takes four complete rotations of the knob to go from stop to full speed. When you select a locomotive that is already moving on either throttle knob, that throttle will continue to run the locomotive at the same speed and in the same direction in which it was traveling before being selected to the throttle.

As you turn the DT402 throttle knobs you will feel a mechanical detent (and hear a beep if your throttle is set up for beeps and clicks). Each time you move the knob, the system processes information. In some cases, the LCD display will not change each time you feel the detent. In the case of increasing and decreasing loco speed, this is because each detent does not equal an increase of 1% speed. If your DT402 is set up for ballistic tracking, the speed with which you move the encoder will affect how the display changes.

You can customize the tracking characteristics of these knobs for either straight line (normal) tracking or ballistic tracking. With straight line tracking each movement of the knob causes a fixed rate of change. With ballistic tracking, the faster you increase or decrease the throttle knob, the faster the data changes in the throttle. Your DT402 was shipped with ballistic tracking as the factory default setting. *To change this setting see Section 16.0 (option: NoBlstic).*

The throttle knobs on the DT402 can also be used to access the recall stack and select a locomotive to run on a throttle or to reverse the direction of the locomotive currently selected on that throttle.

When dialing up numbers with the throttle knobs, the **R Throttle** knob changes 1s and 10s and the **L Throttle** knob changes 100s and 1000s. This makes the throttle knobs easy to use when dialing up four digit addresses.

If you prefer larger throttle knobs, simply remove the standard 1/2” knobs by pulling gently and replace them with larger knobs (up to 1.25”).

10.3 Liquid Crystal Display (LCD)

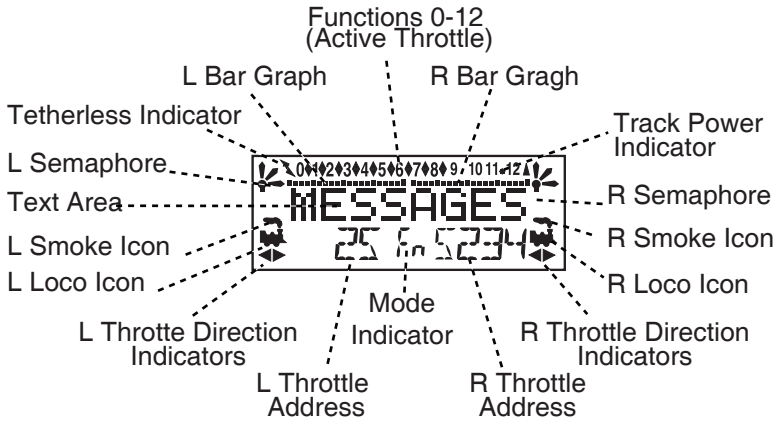

DT402 LCD

10.3.1 Loco Icon

 The L and R Loco icons are used to indicate whether an address is available for selection. A blinking loco icon means that the address is available for selection and a steady loco icon means that the loco address is currently selected or in use by another throttle.

10.3.2 Direction Indicators

◀ The direction indicators are located in the LCD Display of the DT402 directly below the Loco icon. There are separate indicators for the **L** (left) and **R** (right) throttles. If the arrow points to the front of the loco, the throttle is in the forward direction. If the arrow points to the back of the loco, then the throttle is in the reverse direction. If there is not a locomotive selected on a throttle the loco icon will not appear.

 = Forward Direction  = Reverse Direction

Note: These direction indicators are for decoder equipped locos only. They will indicate direction based on the normal direction of travel that you set up for your decoder equipped loco. If you are using an analog loco, the direction indicator may or may not match the actual direction of the analog loco.

10.3.4 Smoke Icon

The Smoke Icon is located just above the Loco icon. Both the **L** and **R** Throttle have a smoke icon. If a loco is selected on either throttle, the Loco icon will appear beside the address of that loco. If nothing is selected, there will be no Loco icon and the address area will show SEL. The blinking smoke icon indicates which throttle is currently active (having its function states displayed in the top line of the LCD). Since both throttles must share the keypad, only one

at a time can have access to the keypad and function controls. The active throttle has access to the function controls and the status of the functions for the active throttle are displayed in the top line of the LCD. To make either throttle the active throttle simply click it once or turn the Throttle knob a little.

No Loco Icon = nothing selected on this side of the throttle



Loco with steady smoke = Keypad and function display not active for locomotive address selected on this throttle.



Loco with flashing smoke = Keypad and function display active for the locomotive address selected on this throttle.

10.3.4 Mode Indicator

The mode indicator, located at the bottom center of the LCD, shows the DT402's current mode of operations.

The DT402 automatically defaults to the Fn mode and returns to this mode when ever the EXIT Key is pressed. **The Mode indicator usually shows what the numeric keys are associated with.** For example, in Fn mode, any entry on the numeric keypad will affect functions. In Sw mode, keypad entries will change turnouts and in Lo mode, entries on the keypad will enter loco address numbers, etc.

The following table provides a list of the Mode indication displayed, the mode name and the use of the mode by the DT402.

Display	Mode	Used For
Fn	Function	Normal locomotive operation functions available on the keypad
Lo	Loco Selection	Locomotive Address Selection Mode
Mu	MU	Multiple unit (consist) operation set up and break up
Sw	Switch	Accessory decoder control (turnouts, etc.) or option switch control
Pw	Power	Turn track power on and off
SE	Status Edit	Change locomotive speed steps to 14, 28, or 128 as needed
Pg	Programming	Paged-Digitrax preferred method
PH	Programming	Physical Register
Pd	Programming	Direct
Po	Programming	Operations Mode (Ops Mode) programming on the mainline.
RE	Recall	Recall one of the last 4, 8, or 16 locomotive addresses used
Fd	Find	Find command issued for active loco, results displayed in text area.
Ec	Edit clock	Edit the time shown on the fast clock
EF	Edit clock rate	Edit the fast clock rate
EA	Edit alarm	Edit the alarm time set for the throttle
Er	Edit routes	Edit routes-shows when your system is running with a DCS100 with routes enabled
E1	Change LocoNet ID	Change LocoNet ID for Infrared or Radio Operation
E?	Other edit modes	Show when your system is running with a LocoNet component that is enabled for additional functionality such as signaling.

DT402 Mode Indicator Display

10.3.5 Text Area

The Text Area of the LCD consists of the eight characters in the middle line of the display. This is where information like locomotive speed, decoder status, turnout position, fast clock, text prompts, messages and programming data are displayed.

10.3.6 L (Left) and R (Right) Throttle Display

The decoder address selected on the **L** Throttle is displayed on the bottom line of the LCD to the left of the Mode Indicator. The decoder address selected on the **R** Throttle is displayed to the right of the Mode Indicator. The address can show as either the 2-digit or the 4-digit decoder address. If no address is selected the display will show "SEL." If a 2-digit address is selected (00-127), the display will show two or three digits. If a 4-digit address is selected (0128-9983), the display will show all four digits including the leading zero.

Throttle in normal operations mode indicated by Fn.
 In Function (Fn) Mode
 Throttle knobs control Loco's Speed & Direction.
 Keypad entries control functions. Track Power Indicator ON

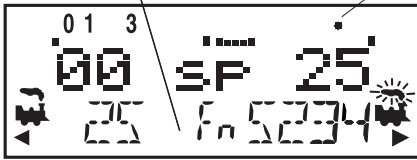

2 digit address 25
 Selected on the
 L Throttle
 Running at 0% speed
 In reverse.

4 Digit address 5234
 Selected on the
 R Throttle
 Running at 25% speed
 In the forward direction
 Functions 0, 1, & 3 on.

10.3.7 L and R Bar Graph

Each throttle has a bar graph located above the text area of the LCD. Each of these indicates the speed setting of the **L** and **R** Throttles graphically from a single dot (0% throttle) to 20 dots (full throttle). This is useful when the text area is showing information other than speed.

Bar Graph showing 50% speed on R Throttle

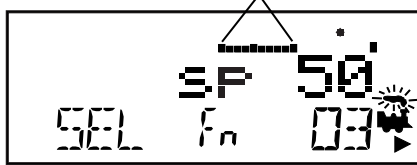

Bar Graph showing full speed on R Throttle

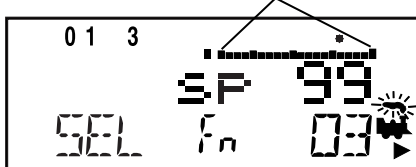

10.3.8 Function Display

Whether functions 0-12 are on or off for the currently active loco address is displayed on the top line of the LCD. In other words, the functions for the active throttle (the one with blinking smoke) are displayed. To view the function status of either throttle, simply press the throttle knob to display the active functions for that throttle.

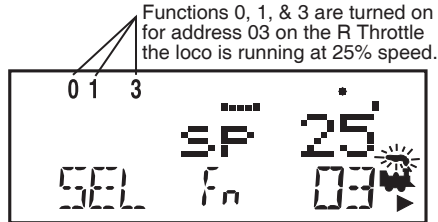

10.3.9 Track Power Indicator

This very small star shaped dot  (shown larger than life) located in the top line of the LCD on the right side indicates the status of the track power.

No indicator = System track power is OFF (Press **PWR** key followed by **N / -** key)

Indicator On Steady = System track power is ON (Press **PWR** key followed by **Y / +** key)

Blinking Indicator and Trk=Idle message = System is in "Idle" and track power is ON (Press **PWR** key followed by **Y / +** key and **Y / +** key again)

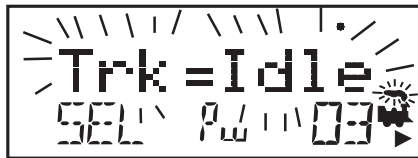

10.3.10 Tetherless Indicator

 The tetherless indicator shows when your throttle is using either infrared or radio communications.

10.3.11 L and R Semaphores-Cab Signaling

 The L and R Semaphores are used when cab signaling is implemented on the layout. More information about signaling and detection will be available on our web site, www.digitrax.com, as these products become available. Information on how to activate these indicators will be included in the manuals for our detection and signaling products. Information will also be available from other LocoNet Certified manufacturers when they have implemented

these features in their software.

The L and R Semaphores will display the following:

 = Clear

 = Approach

 = Stop

10.4 DT402 Keypad

10.4.1 FUNC Key

 The **FUNC** key is used to enter function control mode. Function control mode is the default mode for normal locomotive operation with the DT402. Press this key during any throttle task to return to normal loco operation mode with function controls active on the numeric keypad.

10.4.2 MU Key

 The **MU** key is used to enter consist set up mode. Once the MU Key is pressed, you will be prompted by the throttle to use the **Y / +** or **N / -** keys to add locos to or remove locos from consists.

10.4.3 LOCO Key

 The **LOCO** key is used for selecting loco addresses on to the throttles so that the address is controlled by the throttle. Sometimes people call this “assigning locos to throttles.”

10.4.4 SWCH Key

 The **SWCH** key is used for entering switch control mode. Once this key is pressed, you will be prompted to select a switch address and issue a thrown or closed command. Switch control mode is used in normal operation for operating turnout machines and in set up mode for setting up option switches in the throttle and command station.

10.4.5 L and R Reverse Keys

The L and R Reverse Keys change the direction of travel of the loco on the related throttle when the throttle is in Fn (Normal Operation) Mode.

 The **REVERSE / R** key changes direction of the address on the “**R**” or Right Throttle.

 The **L / REVERSE** key changes direction of the address on the “**L**” or Left Throttle.

10.4.6 Y / + and N / - Keys



Y / + key and



N / - key are used:

- to turn track power on and off,
- to increase or decrease loco speed.
- to link and unlink locos during MU'ing.
- to accomplish tasks using system editors.

These keys can be set up to act in two different ways:

Repeating (also called typematic) so that if you hold a key down it will continue to increase or decrease step by step until you release the key. This option is active when your throttle is set up for ballistic tracking. Your DT402 was shipped from the factory with this feature enabled.

Single Press so that you will must press the key each time you want to increase or decrease. This option is active when your throttle is set up for straight line tracking.

See Section 16.0 (option: NoBlstic) for information on changing this setting on your DT402.

10.4.7 DISP Key



The **DISP** key is used for displaying programming information and dispatching loco addresses.

10.4.8 PROG Key



The **PROG** key is used to enter programming mode and to toggle among the programming modes available for use.

10.4.9 EDIT Key



The **EDIT** key is used to enter the Edit Mode for editing the fast clock, routes, signaling, etc. It is also used to status edit decoders while in locomotive address selection mode.

10.4.10 FIND Key



The **FIND** key is used in conjunction with a layout instrumented for Digitrax Transponding and locos or cars equipped with transponders to find the location of those pieces of rolling stock on the layout.

10.4.11 BACK Key



The **BACK** key is used to go back one step.

10.4.12 PWR Key

 The **PWR** key is used to enter power mode for turning layout power on and off. Once you press this key, you will be prompted to use the **Y / +** key to turn power on or the **N / -** key to turn power off.

The **PWR** key is also used to turn on and off the flashlight feature. The flashlight LED will be on as long as you hold down the **PWR** key.

10.4.13 OPTN / t Key

 The **OPTN / t** key is used to enter the Option Mode to set throttle and system options. It is also used to issue **t** (thrown) commands when the throttle is in Switch mode.

In the case of turnout control:

 **t**=thrown, turnout is set for the diverging route through the curved leg.

10.4.14 CLOC / c Key

 The **CLOC / c** key is used to toggle between displaying and not displaying the current fast clock time. It is also used to issue **c** (closed) commands when the throttle in Switch mode.

In the case of turnout control:

 **c**=closed, turnout is set for the main line with routing through the straight leg of the turnout.

10.4.15 EXIT Key

 The **EXIT** key is used to exit the current throttle task without making changes. Pressing this key will usually return the DT402 to Fn mode for regular locomotive operation.

10.4.16 ENTER Key

 The **ENTER** key is used to complete the current throttle task and return to Fn mode for normal operations.

10.4.17 EMRG STOP Key

 Your DT402 comes from the factory set for “Local” Stop. When you press the **EMRG STOP** key, the loco address that is active on your display (the one with the blinking smoke) will stop. When you press the **EMRG STOP** key again, the loco address on the other throttle of your DT402 will stop.

You can change the DT402’s Option Setting (ES->Idle) to set the **EMRG STOP** key to “Global Stop”. (See Section 16.0.) With the Global Stop option enabled, pressing the **EMRG STOP** key sets the track status to IDLE and stops all locos on the layout. You will see the DT402’s TRACK POWER indicator blinking on and off. To resume operations, press the **PWR** key followed by the **Y / +** key to

return locos to their speed prior to the EMRG STOP. Press **EXIT** key to leave Pw mode and return to Fn mode after turning track power back on with **PWR** key and **Y / +** key.

10.4.18 Full Numeric Keypad

The numeric keys on the keypad are usually related to the throttle mode shown in the LCD's mode indicator area. For example, when the mode is Fn, the numeric keys are used for function control. When the mode is Lo, the numeric keys are used to enter loco addresses. When the mode is Sw, the numeric keys are used to enter switch addresses.

The **0-12** keys allow direct entry of loco and switch addresses as well as Configuration variables (CVs) values during selection and programming. These keys also give direct access to functions 0-12 during normal operation of locos. Special number keys:



The **LAMP / 0** key is most often used to turn on and off the loco's head lights. It can also be used for other functions as desired.



The **BELL / 1** key is most often used to turn on and off the bell sound in locos equipped with sound decoders.



The **HORN / 2** key is most often used to turn on and off the horn sound in locos equipped with sound decoders. This function key is a momentary key that will activate the sound as long as the key is held down. This key also pressure sensitive to allow for the use of sound decoders that incorporate a "playable whistle."



The **COUPLER / 3** key is most often used to activate couplers. It can be used for any function.



The **A / 10**, **B / 11** and **C / 12** keys make it easy to use functions 10-12 and give more flexibility for future features by providing A, B and C as possibilities.

10.4.19 Infrared Emitters

Your DT402 has two infrared LEDs in the cable end of the throttle. These emitters send infrared signals that can be used by LocoNet compatible Infrared receivers to give you tetherless operation. *See Section 14.2 for infrared operation information.*

11.0 How to Select and Run Trains

11.1 Turn track power on and off

The TRACK POWER indicator on your DT402 display shows the track power status. There is also a TRACK STATUS LED on your Command Station. If the TRACK POWER indicator is lit then track power is on. To turn the track power on or off:

1. Press the **PWR** key on the DT402. You will see a screen similar to the one below. You will now be able to toggle the track power on/off:

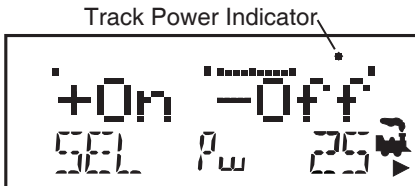

2. Press the **N / -** key to toggle the track power off. The TRACK POWER Indicator on your DT402 and on your Command Station will go off.
3. Press the **Y / +** key to toggle the track power on. The TRACK POWER Indicator on your DT402 display and the TRACK STATUS Indicator on your Command Station will come on solid.
4. Press the **PWR** key again to return the DT402 to the operating mode.
5. If the TRACK POWER Indicator is blinking then the layout is frozen in the "IDLE" state and no locomotives will move. To exit this state simply turn on track power again. This is a common issue with new users, and is easy to correct.

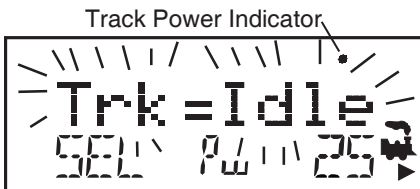

11.2 Select and Run An Analog Loco on Address “00”

1. Place an analog locomotive (one without a decoder) on your layout. While the analog loco is sitting still, you will hear the characteristic “singing” caused by the DCC track signal when it is applied to analog locomotives. Once the analog loco is moving, this sound will change and be less noticeable. (Digitrax recommends that analog locos not be left sitting on DCC powered track for long periods of time when they are not running.)
2. Check the TRACK POWER Indicator is steady on your DT402’s display and the TRACK STATUS LED on Command Station is lit .
3. Activate the DT402’s **R** Throttle knob by turning it a 1/4 turn in either direction or by pressing the **R** Throttle knob once if there is a current loco address and double click* if SEL appears in the **R** address. If there is a loco address, the **R** Loco Smoke will start flashing. If no loco has been previously selected on this throttle it will flash “SEL”.
4. Press the **LOCO** key then 00 on the keypad. You can also use the **R** throttle knob to dial in the number. You will see a display similar to this:

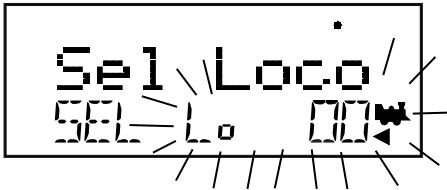

5. Press the **LOCO** key again to select address 00 on the throttle. You can also press the **R** Throttle knob once to select the loco address and return to Fn mode for normal operation.
- Note: The **EXIT** key can be used at any time to return to Fn mode for normal loco operation.
6. Turn the **R** Throttle knob clockwise slowly to increase the speed of the analog locomotive. As the speed increases, the locomotive on the track will begin to move. Your command station’s TRACK STATUS indicator should change color as you change the speed setting.
 7. Press the **REVERSE / R** key on the right side of the DT402 or double click the **R** Throttle knob to reverse the direction of the analog loco. The **R** Direction Indicator will toggle between the left and right arrows. In the case of the analog loco, the indicator only indicates a change in track polarity and the change in physical direction of the loco-NOT THE ANALOG LOCO’S ACTUAL FORWARD OR REVERSE DIRECTION OF TRAVEL.

* To double click the throttle knob, quickly press down on the throttle knob twice within about 1/2 second. You will hear a click each time you press down on the throttle knob.

11.3 Select and Run A Decoder-Equipped Loco

Each decoder has an address. To select a decoder-equipped locomotive and run it on either throttle, you must know its address. Digitrax decoders are set up at the factory with the “default” 03. This means that when you take a Digitrax decoder out of the package and install it in your loco, you can select address 03 on your throttle and run the decoder. The first Configuration Variable (CV) programmed by most users is the decoder’s address since it is not very useful to have all of your locos run on address “03.”

If you do not know the address of the decoder equipped locomotive you want to run, you can simply program the decoder’s address and select it to run using the new, known address. *See Section 16.1 and your Digitrax Decoder Users Manual for a complete discussion of decoder addressing.*

1. Place a decoder equipped locomotive on your layout.
2. Check the TRACK STATUS indicator is steady on your DT402’s display and the Command Station TRACK STATUS LED is lit (track power on).
3. Activate the DT402’s **L** Throttle knob by turning it a 1/4 turn in either direction or by pressing the **L** Throttle knob once if there is a current loco address and double click if SEL appears in the **L** address. If there is a loco address, the **L** Loco Smoke will start flashing. If no loco has been previously selected on this throttle it will flash “SEL”.
4. Press the **LOCO** key. The left side of the display will begin flashing. You will see a display similar to this:

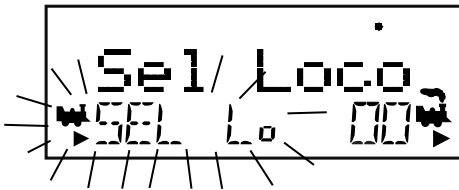

5. Use the numeric keypad to enter 03 or use the **R** Throttle knob to select Address “03” in the left side of the display. (The **R** Throttle knob changes 1s and 10s, the **L** Throttle knob changes 100s and 1000s.)

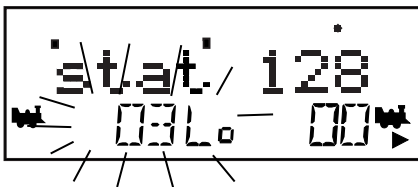

6. Press the **LOCO** key again to select address 03 on the throttle. You can also press the **L** Throttle knob once to select the loco address and return to Fn mode for normal operation.

The illustration below shows the display after address “00” is selected on the **R** Throttle and address “03” is selected on the **L** Throttle, We see the TRACK POWER On Indicator in the top line, the speed bar graphs at 0 speed and the text area also at 0 speed for both throttles.

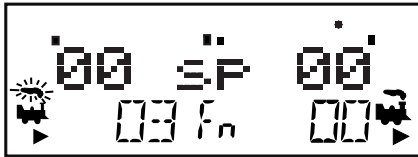

7. Turn the **L** Throttle knob clockwise slowly to increase the speed of the decoder equipped locomotive. As the value in the left display increases, the locomotive on the track will begin to move.
8. Press the **L / REVERSE** key on the left side of the DT402 or double click the **L** Throttle knob to reverse the direction of the decoder equipped loco. The **L** Direction Indicator will toggle between the left and right arrows. In the case of the decoder equipped loco, the arrow indicates locomotive direction (forward or reverse), not the direction on the track.
9. Use the **R** Throttle knob and **REVERSE / R** key to control the analog loco and the **L** Throttle knob and **L / REVERSE** key to control the decoder equipped loco. You can control both at the same time.

Throttle in normal operations mode indicated by Fn.
 In Function (Fn) Mode
 Throttle knobs control Loco's Speed & Direction
 Keypad entries control functions

Track Power Indicator ON

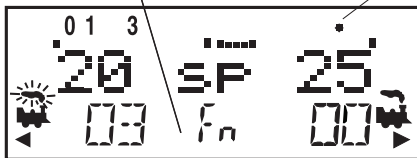

2 digit address 03
 Selected on the
L Throttle
 Running at 20% speed
 In reverse
 Function 0, 1, & 3 on.

An analog loco address 00
 Selected on the
R Throttle
 Running at 25% speed
 The direction arrow below
 the Loco Icon **does not**
 indicate actual direction
 for Analog locos.

Notice as you use each throttle knob or direction key that the loco with the “blinking smoke” will change to that side of the throttle. The side with the “blinking smoke” indicator is the active throttle. To control the headlight or other functions, the locomotive must be on the active throttle.

11.4 Releasing An Address From A Throttle

When you are finished running a locomotive address, release it from your throttle so that it is available for other throttles to select and run.

Simplex Radio and Infrared Throttles must be plugged in to LocoNet to release an address from your throttle. You can disable this safety feature by setting your DT402's Options to allow tetherless release (See Section 15.0 for instructions). Duplex Radio throttles can release addresses without plugging in.

1. Use the throttle to make the locomotive's speed zero (this step is optional but strongly recommended as the loco will continue to move if speed is not reduced to zero).
2. While the loco's address and speed information is displayed, press the **LOCO** key to go into Lo select mode. This will release the address from your throttle immediately.
3. The address will begin to blink in the display. Press the **DISP** key to dispatch the address on the throttle and the locomotive will be released to the system and marked as a dispatched address. The display on your DT402 will show SEL for the throttle. See Dispatching below.
4. If you press the **LOCO** key again, the throttle will begin flashing the address you just released. You can re-select that address by pressing the **LOCO** key or you can use the throttle knobs or key pad to browse to a new address and select it instead.

11.5 Dispatching addresses or consists

Dispatching is a special feature incorporated in the LocoNet language to meet the needs of operators that wish to enforce a strict discipline in how operators gain access to locomotives during an operating session. Dispatching also lets you run consists with basic throttles that can't set up their own consists and run four-digit addresses on basic throttles that only have two digit capability. It lets you have newcomers run trains on the layout without giving them access to the entire operation.

When you dispatch a locomotive address or consist to your LocoNet system, you make it available to be acquired by another throttle. Only one address at a time can be marked as a dispatched address in the system. The dispatched address can be a single locomotive address, either two digit or four digit, or a consist that was set up by the DT402. The TOP locomotive in a consist or MU can be dispatched to transfer control of the entire consist to another throttle.

To dispatch a locomotive address using a the DT402

1. Press the **LOCO** key to enter address selection, browse to the address you want to dispatch.
2. Press the **DISP** key to dispatch it to your LocoNet system.!

NOTE: DT402R and DT402 throttles must be plugged in to LocoNet to dispatch loco addresses. DT402D does not have to be plugged in to dispatch.

11.6 Recall a Loco

Your DT402 stores the last 4, 8, or 16 unique loco addresses used by the throttle in a recall stack. Your DT402 defaults to a 4-address recall stack. See Customizing Your Throttle Section 15.0 for information on how to change the recall stack depth.

For example if you have your DT402 set up for an 8 deep recall stack and the last 8 addresses you selected were: 00, 1987, 52, 0678, 03, 8819, 25, and 2500, these addresses will be in the recall stack. If you have selected any of these addresses more than once, it will not be stored twice, only the addresses not already stored will be added to the stack. The recall stack is not stored in numeric order. Recall makes it convenient to select locos that you have used previously without having to enter the address again.

To Recall the last 4, 8, or 16 addresses on the R Throttle

1. Press and hold the **R** Throttle knob. The word "Recall" will appear in the text line in the middle of the display.
2. When "Recall" appears in the display, release the knob. "RE" will appear in the mode indicator in the center of the bottom line on the display. The right side address display will begin to flash prompting you to select a locomotive.
3. Turn the **R** Throttle knob to browse through the last 4, 8, or 16 addresses selected in the system. Whether you browse 4, 8 or 16 addresses depends on how you set up your throttle's options. As you browse through the addresses, the throttle will display their current speed on the bar graph and their status in the text line of the display. Addresses are displayed in the order they were used by the throttle (not in numeric order).
4. Press and release the **R** Throttle knob or the **LOCO** key to select the desired loco address. Once the locomotive is selected the **R** Throttle knob will be able to control the speed control and direction of that locomotive.

Follow the same steps for recall on the **L** Throttle.

11.7 Stealing: Forcing An Address Selection

If you try to select a loco address that is already selected on another throttle the DT402 will display "Steal?=Y" in the text area. This is a safety interlock to prevent operators from taking control of locos that are already selected on other throttles. Occasionally it is necessary to override this interlock to gain control of a loco that is "lost" for whatever reason. This override is called stealing and can result in having a single loco address selected on two different throttles at the same time.

To steal an address with the DT402:

1. Press the **LOCO** key to enter selection mode.
2. Enter the address of the loco you want to steal and press the **LOCO** key again.

3. The DT402 will display “Steal?=Y” in the text area if the loco can be stolen.
4. Press **Y / +** key if you want to steal.
5. Press **N / -** (or any other key) if you do not want to steal.

Once a throttle has “stolen” a loco address, the slot following mode becomes active and both throttles will update speed and direction information for the loco address. This can result in seemingly strange locomotive behavior especially if one throttle is trying to stop the loco and the other is trying to speed it up at the same time.

When you have gained control of the stolen loco and are finished running it, release it from your throttle by setting the loco’s speed to 0 and pressing the **LOCO** key followed by the **DISP** or **EXIT** Key.

11.8 Slot Following

When a DT402 detects that a loco address that is in-use on one of its throttles is being changed by another throttle or computer, it will cause the DT402 to “click” every time it sees a remote throttle change its locomotive settings. If that locomotive is in the active throttle, its speed display will also show the changes. This is called slot following. This allows two throttles to run a single locomotive address with both throttles being able to send commands to the loco. Both throttles will show the current speed and direction of the locomotive in their displays.

Slot following is useful for training new operators. The supervisor can “steal” a locomotive that is selected on a trainee’s throttle and be able to “look over the trainee’s shoulder” and closely supervise that locomotive’s control. The supervisor can gain instant override control without having to physically “grab” the trainee’s throttle. This lets you have unskilled visitors participating and enjoying operations without too much anxiety for either party.

Slot following also allows a computer on LocoNet to run CTC and routing control programs with automated control over locomotives. The computer can control speed and stop engines automatically while letting the engineer with the throttle in his hand know what is happening.

Note: Slot following does not update continuously when DT402D is used in Duplex Power Save Mode (as shipped from the factory). For continuous slot following updates, change Option DxRxLPwr to OFF. This will significantly increase battery consumption when slot following is in use.

11.9 “slot=max” Message

If the text area of the DT402 shows the message slot=max during the selection process this means that the Command Station reached the limit of locomotive addresses that it can manage at one time. If you want to select additional addresses, you will need to release one or more loco addresses to continue the selection process.

12.0 Stop

12.1 Setting A Loco to Zero Speed

Turn the Throttle Knob that the loco address is selected on counterclockwise until the speed display shows 00 and the loco stops moving. This lets you slow down your loco and stop it prototypically.

If you have set up deceleration for the loco and you move the throttle knob to 0% speed, your loco will slow down and come to a stop at the programmed deceleration CV value. We strongly recommend that you run your locos with the factory default of no deceleration until you are familiar with your system.

If the deceleration CV value you set for a particular loco is very large, this can make it look like the loco is not stopping on command because the deceleration CV value is causing the loco to take a long time to come to a stop.

12.2 Emergency Stop

DT402s have two ways of handling an emergency stop command. This is set up in Throttle Option Set Up. When you use emergency stop, the deceleration rate programmed into the decoder will not have an effect and the stop will be immediate.

12.2.1 Local Stop-Factory Default

To stop only the locos in the local DT402 display.

1. Press the **EMRG STOP** key to stop the loco that is active in the DT402's display. To resume operation, use the throttle knob associated with that address to increase the loco's speed.
2. Press the **EMRG STOP** key again to stop the loco that is associated with the other throttle on the DT402. To resume operation, each operator must use their throttle to set their loco's speeds back to the desired speed.

12.2.2 Global Stop-Optional Setting

1. See Customizing Your Throttle, Section 15.0 (option ES->Idle), for setting the DT402 Options to use the **EMRG STOP** key for Emergency Stop.
2. Press the **EMRG STOP** key to stop all locos on the layout.
3. To resume operations, press the **PWR** key followed by the **Y / +** key again and the locomotives will start running again at the same speed they were running prior to STOP mode.
4. To exit PWR mode, press the **PWR** key or the **EXIT** key.

12.2.3 Track Power Off Stop

To stop everything on the layout.

1. Press the **PWR** key followed by the **N / -** key while the track power is on. This will turn track power off and will cause all locos to stop.
2. Press the **PWR** key followed by **Y / +** key again and the locomotives will start running again at the same speed they were running prior to STOP mode. To exit **PWR** mode, press the **PWR** key or the **EXIT** Key.

13.0 Controlling Functions

The DT402 Throttle will control up to 29 (F0-F28) functions when operating in walkaround and radio mode. When operating in IR mode the DT402 throttles will control up to 9 functions (F0-F8). The numeric keypad is always active in the normal Fn operation mode. The functions that are currently on for the active loco will be displayed on the top line of the DT402 display. The following figure shows an example of how the display looks when functions 0 and 1 are turned on for loco 1652 on the **R** Throttle.

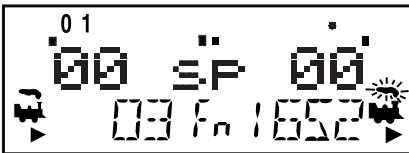

13.1 Controlling Functions F0-F12

1. Determine which throttle you want to control functions on and make it the active throttle by single clicking the Throttle knob or by turning the Throttle knob a couple of clicks.
2. If the Mode indicator in the center of the bottom line of the display (between the loco addresses) does not show **Fn**, press the **FUNC** key once to enter the function mode for the active throttle.
3. The DT402's numeric keypad is always active in function mode during normal loco operations. When the mode indicator on your DT402 shows **Fn**, simply press any number on the keypad to activate or deactivate any function from 1 to 12. The function is on for the active loco when the function number is displayed on the top line of the display.

Function 0 (F0)

Press the **LAMP / 0** key to toggle F0 between on and off. Each time the **LAMP / 0** key is pressed while in function mode, F0 will change from off to on or vice-versa. The top line of the display will display a 0 when the F0 is on and will be blank when F0 is off. F0 is most often used for reversing head lights but can be set up for other functions as well.

Function 2 (F2)

Press the **HORN / 2** key on the numeric keypad. F2 is labeled with a whistle icon to remind you that this is the preferred function for whistle or horn operation.

F2 is a special non-latching function. This means that F2 can be used to control a whistle or horn sound from the decoder. It will only sound when F2 is being held down. This lets you vary the length of time that the whistle blows, just like the prototype.

Functions 1, 3, 4, 5, 6, 7, 8, 9, 10, 11, and 12

Press the button on the numeric keypad that corresponds with the function number you want turn on/off. The top line of the display will display the numbers of the functions that are on for the active loco address.

F1 is labeled with a bell icon to remind you that this is the preferred function for bell operation and F3 is labeled with a coupler icon to remind you that its preferred function is coupler operation.

Note: DT402 may process functions slightly differently depending on command station capabilities.

13.2 Controlling Expanded Functions F13-F19

The DT402 series throttles can address additional functions F13-F28. To address the upper function ranges, the throttle design incorporates a '+10' and '+20' key action. These keys, along with the standard numeric keypad, permit the full function range to be addressed. Here's how it's done:

1. While holding the **FUNC** key down, press the **1** key then release both keys simultaneously. The throttle will go into the '+10' mode and display will show the following:

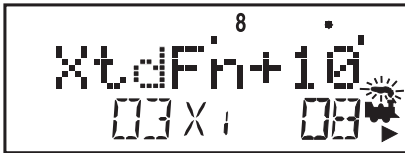

2. Select the second digit from the throttle's numeric keypad and you're done.

Example: To turn on function 18, just hold the **FUNC** key down while pressing the **1** key then releasing both keys simultaneously. Next press the **8** key to turn on function 18. Just press the **8** key again to toggle off. The figure '8' on the top line of the display will toggle on and off as will the locomotive's function.

3. Press the **FUNC** key once to exit the '+10' function mode and return to the normal single digit function address mode. Please Note that you will have to return to the '+10' mode in order check whether any functions in the +10 range are active.

13.3 Controlling Functions 20-28

1. While holding the **FUNC** key down, press the 2 Key then release both keys simultaneously. The throttle will go into the '+20' mode and display will show the following:

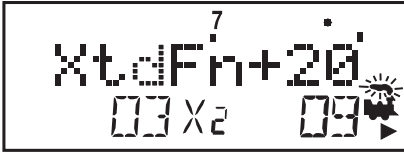

2. Select the second digit from the throttle's numeric keypad and you're done.

Example: So if you want to turn on function 27, just hold the **FUNC** key down while pressing the **2** key then releasing both keys simultaneously. Next press the **7** key. That's it. You've just turned function 27 on.

3. Press the **FUNC** key once to exit the '+20' function mode and return to the normal single digit function address mode. Note that you will have to return to the '+20' mode to check whether any functions in the +20 range are active.

13.4 Controlling Functions On Consisted Locomotives

Even though an individual locomotive is part of a consist and you can't control its speed and direction separately from the consist, you can still control its function outputs independently as follows:

1. Press the **LOCO** key and select the address of the locomotive that is a part of a consist for which you want to control functions.
2. Press the **LOCO** key again to select the loco address on your throttle. The speed value will show "cn" to remind you that you can only control functions on the loco and not its speed.
3. Use the steps described in Controlling Functions Sections 13.1 through 13.3 to turn on or off the functions on the consisted loco.

14.0 Tetherless Operation

14.1 General Tetherless Operations

All DT402s can operate with out plugging in to LocoNet. This allows you to disconnect from the LocoNet and still control your locomotives while walking around your layout.

- The DT402/402R/402D are all “InfraReady.” All come with IR LEDs that send infrared signals to the layout. To use this InfraReady capability, you just need to install one or more infrared capable receivers (UR90, UR91 or UR92) on your layout. You’ll also need a new or known good 9-volt battery installed in the throttle.
- The DT402R is a simplex radio equipped throttle. To use your DT402R as a simplex radio throttle, you will need to install a UR91 simplex radio receiver on your layout. You’ll also need to install a new or known good 9-volt battery in the throttle.
- The DT402D is a duplex radio equipped throttle. To use your DT402D as a duplex radio throttle, you will need to install a UR92 duplex radio transceiver on your layout and a new or known good 9-volt battery in the throttle.

14.1.1 Selecting a Locomotive-Safety Selection

While tetherless, the DT402 (IR only), DT402R (IR and Radio) and DT402D (IR only) operate as one-way transmitters. In these cases, the DT402, DT402R & DT402D (in IR mode) must be plugged into LocoNet to select an available locomotive address. After an address is selected, you can unplug from LocoNet and run the selected addresses with infrared or radio. The throttle will automatically convert to infrared or radio operation, all speed, direction, function, operations mode programming, and switch commands.

The DT402D throttle has full duplex capabilities. Once the DT402D has been configured to communicate in duplex mode with a UR92, the full functionality of the 402 series throttles can be enjoyed without ever plugging in to the layout, including joining a Duplex Group, programming decoders, selecting, running and releasing locomotives and other layout features.

14.1.2 Releasing An Address Using IR or Simplex Radio

Releasing a locomotive address makes it available for use by other throttles in the system. Two options are available for tetherless release. These options are set by DT402 Option setup, *see Customizing Your Throttle, Section 16.0*.

No tetherless release allowed: if the **LOCO** key is pressed while the DT402/R is running in tetherless mode, the addresses selected will not be released unless the throttle is plugged in to LocoNet. This is the factory default, but can be changed in the throttle’s option setup (see *Section 16.0*).

Tetherless release allowed: if the **LOCO** key is pressed while the DT402 and 402R are running in tetherless mode, the address selected on that side of the

throttle will be released immediately and that throttle will become inactive. To re-select this loco address plug your DT402/R in to LocoNet and select the loco address on the throttle.

14.1.3 Multiple Unit Operations

Consists must be assembled and broken up while the DT402/R is plugged in to LocoNet. MU operations are locked out while the DT402/R is running tetherless. Once a consist is assembled, it can be operated normally using the DT402/R in tetherless mode.

14.1.4 Programming while tetherless

Ops mode programming is the only programming method that will work while the DT402/R is operating as a simplex radio throttle. If you press the **PROG** key to enter programming mode, the DT402 running as tetherless will default to the Po mode (ops mode programming). The DT402 must be connected to LocoNet to use service mode programming and access any of the other programming modes available. Duplex throttles can program without plugging in any mode.

14.1.5 Switch Mode

The DT402 will operate in Sw mode while tetherless. It can operate turnouts and routes using the **OPTN / t** and **CLOC / c** keys in the normal manner.

14.1.6 Ballistic Tracking

While running tetherless, ballistic tracking will feel slightly different from when the throttle is connected to LocoNet.

14.1.7 Fast Clock

When using the fast clock option, the DT402/R will keep track of and display fast time based on the last synchronized system fast time when the DT402/R was connected to LocoNet. If the fast time is edited by another throttle connected to LocoNet, the DT402/R will not see this change until it is plugged into LocoNet at which time its display will be updated.

14.1.8 Throttle Keypad Lock

While the DT402/R/D are being used tetherlessly, there are occasions when you may want to disable the throttle's controls to prevent accidental commands being sent to the railroad. For example, your train is in a siding waiting for another train to pass. You put your throttle in your pocket and go take a break. By locking the throttle controls, you will not be able to accidentally start your train if you bump your throttle knob or press the **Y / +** key.

To lock/unlock the controls on your DT402

1. Press both the **Y / +** and the **N / -** keys at the same time. When you are locking the keypad be sure to press both the **Y / +** and **N / -** keys AT THE SAME TIME to avoid sending a speed command to the active loco.
2. The throttle will display "Lock=+&-" in the display and none of the controls will function until you unlock them.

3. Press both the **Y / +** and the **N / -** keys at the same time again. This will return the throttle to normal operation.
4. Plugging the throttle into LocoNet will also unlock the throttle.

14.2 Using the DT402 Series Throttle in IR Mode

1. For Infrared operation, plug in at least one Digitrax IR receiver (UR90, UR91 or UR92) to your working LocoNet. Because infrared signals are line of sight, more than one receiver may be necessary for optimal performance in your layout room. *See wireless IR receiver manual for more information about installing UR90, UR91 or UR92s on your layout.*
2. Plug your DT402 Throttle (with battery inserted) into the LocoNet and it will verify that at least one infrared is connected to LocoNet. The throttle will display Ir followed by the current LocoNet ID. The example below shows that the DT402 has detected a Ir receiver and that the current LocoNet ID is 01. The throttle has loco addresses 03 and 1280 selected.

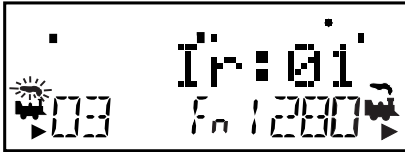

3. Unplug the DT402 from the LocoNet. The tetherless indicator on the display will come on and the tetherless message will display for a few seconds indicating whether the throttle is running in Ir (infrared) mode. It will also display the LocoNet ID (00-07) that the throttle is logged on to.
4. When you single click or turn either throttle knob to activate it, the DT402 will show the normal operating mode Fn display with the tetherless indicator lit in the upper left corner of the display.



If an untethered DT402 operating as a tetherless throttle detects no user throttle activity for about 3 minutes, it will enter power save mode. The display will show:

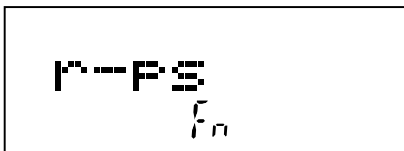

The throttle may flash the Fn mode indicator about every 60 seconds. This

happens when the throttle “pings” the system to let the command station know that it is still part of the system. This keeps the system from releasing that locomotive back to the system and making it available to be selected by another throttle.

Press and hold the **PWR** key to bring the throttle out of power save mode without making any changes to throttle settings. Any key strokes or movement of the throttle knobs will also bring the DT402/R out of power save.

14.2.1 LocoNet ID Change

Your DT402R will log on to the LocoNet ID offered by compatible infrared or duplex radio transceiver it sees when plugged in to LocoNet. The default LocoNet ID is 00. It may be necessary to change the LocoNet ID if more than one club is operating in close proximity at a train show so that the commands sent by one club will not interfere with the commands sent by other clubs. LocoNet ID Change does not pertain to DT402D/UR92 operation, see Duplex radio instructions for those products. To change a LocoNet ID:

1. Disconnect a DT402/R from the LocoNet for which you want to change the LocoNet ID. If you are operating several throttles on your layout, it is necessary only to disconnect one throttle.
2. Press and hold down the **EDIT** key on the DT402/R and then plug it back in to LocoNet. Release the **EDIT** key after plugging in the throttle.
3. The DT402/R will display E1 in the Mode Indicator and the current LocoNet ID “lr:0n” where “n” is the current LocoNet ID. Use the **R** throttle knob to change the LocoNet ID. You can set the LocoNet ID to be any number from 00 to 07. In the example below the LocoNet ID has been set to 03.

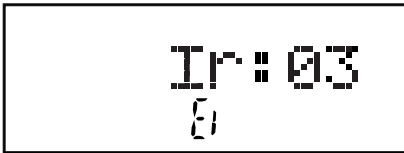

4. Press **ENTER** key to set the system to the new LocoNet ID.
5. The DT402/R used to change the LocoNet ID will automatically log on to the new LocoNet ID.
6. Unplug and reconnect any other DT series infrared or radio throttles that will be used on this system so that they can log on to the new LocoNet ID number and be able to operate on the system.

14.2.2 Adding a new UR90, UR91, or UR92 to the LocoNet

If you add a new UR90, UR91 and/or UR92 to the system you must re-synchronize the IDs by setting the LocoNet ID (00-07) as described above AFTER all the UR91, UR91 and UR92s you are adding are connected to LocoNet. If

you are operating in an area where more than one LocoNet system is operating nearby, be sure to coordinate with other layouts so that each one has its own unique LocoNet ID before beginning operations.

14.3 Using the DT402R in Simplex Radio Mode

1. For Radio operation with the DT402R, plug in at least one Digitrax Simplex Radio receiver UR91 to your working LocoNet. Most layouts only need one UR91. *See the manual with your wireless receiver for more information about installing UR91s on your layout.*
2. Plug your DT402R (with good battery inserted) into the LocoNet and it will verify that at least simplex radio receiver is connected to LocoNet. The throttle will display rA followed by the current LocoNet ID. This example shows that the DT402R has detected a simplex radio receiver and that the current LocoNet ID is 01. The throttle has loco addresses 03 and 1280 selected.

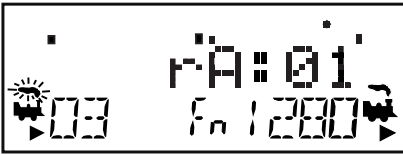

3. Unplug the DT402R from the LocoNet. The tetherless indicator on the display will come on and the tetherless message will display for a few seconds indicating whether the throttle is running in rA (radio) mode. It will also display the LocoNet ID (00-07) that the throttle is logged on to.
4. When you single click or turn either throttle knob to activate it, the DT402R will show the normal operating mode Fn display with the tetherless indicator lit in the upper left corner of the display.



If an untethered DT402R operating as a tetherless throttle detects no user throttle activity for about 3 minutes, it will enter power save mode. You will see:

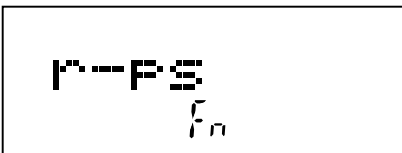

The throttle may flash the Fn mode indicator about every 60 seconds. This

happens when the throttle “pings” the system to let the command station know that it is still part of the system. This keeps the system from releasing that locomotive back to the system and making it available to be selected by another throttle.

Press and hold the **PWR** key to bring the throttle out of power save mode without making any changes to throttle settings. Any key strokes or movement of the throttle knobs will also bring the DT402/R out of power save.

Note: Fast clock caution. If you use power save mode, the DT402’s local fast clock copy will deviate from the LocoNet system clock. The fast clock will re-synchronize with your LocoNet system fast clock when it is plugged in again.

14.4 Using the DT402D Throttle in Duplex Radio Mode

There are three elements involved in duplex radio operation between the DT402D and the UR92: Duplex Group Name, Duplex Channel, and Duplex Group Password. These elements can be configured to provide a unique connection when operating in a multisystem environment.

See the Quick Start guide on *Section 2.0* for setting up the UR 92 and Joining the DT402D to the Duplex Group. There are several additional operation and configuration options for the Duplex Group covered below.

14.4.1 Join a Duplex Group In Duplex Radio Mode

The DT402D will remember the last Duplex Group that it joined and display that Group Name upon startup. If the Duplex Group is available, the DT402D will rejoin the Group. If the Group is not available, you will get an Idle screen. To select a Group, follow these instructions

1. Make sure there is a battery installed in the DT402D. Press the **OPT / t** key. (If you are starting from the Idle screen hold the key down for 3 seconds to power up the Throttle.) You will see:



2. Press the **FIND** key to display the rf search mode and scan the last active channel. ScanNets will briefly appear on the display and if there is no Group available on the last Channel used (19 in our example) you will see:

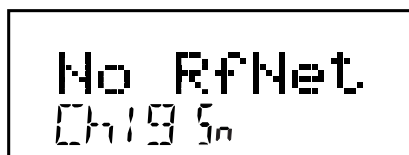

3. Press the **Y / +** or **N / -** key to change the Channel up or down. At each channel the display will show “hit Find” to search for a Duplex Group name operating on that channel.

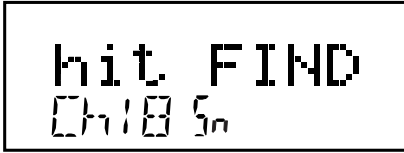

4. When the DT402D discovers a Duplex Group the name will blink in the display. In the example below, the Group Name is the default (Dtx0048) for a UR92 that has been installed in another system.

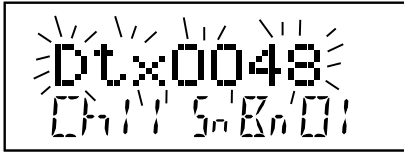

5. Press the **ENTER** key to join the Group and then select the loco address you want to run on the layout. You are now ready to run your train.

14.4.2 Configuring the Duplex Group name

The UR92 ships from the factory with a default Duplex Group name of “Dtxnnnn”, where nnnn is the serial number. It is easily changed using the following steps:

1. Plug a DT402D throttle into the UR92.
2. Press the **EXIT** key.
3. Press the **OPT / t** key then the **EDIT** key.
4. Turn the **L** Throttle knob to position the cursor. The character will blink to show it has been selected.
5. Turn the **R** Throttle knob to choose the character. The character will continue to blink until you move to the next position or press the **ENTER** key.



6. Repeat steps 3 and 4 until desired name is obtained.
7. Press the **ENTER** key to change the Duplex Group name. DT402D throttles will need to rejoin on the new Group name.

14.4.3 Configuring the Duplex Group Channel (11-26)

The UR92 ships from the factory with the default Duplex Group default radio channel set to 11. You can select channels 11 through 26 for the radio channel.

1. Plug a DT402D throttle into the UR92.
2. Press the **EXIT** key.
3. Press the **OPTN** key then the **EDIT** key.
4. Press the **Y / +** key to increase the channel number, or
5. Press the **N / -** key to decrease the channel number. In the example below, we have changed the Group name to JBS&J RR and entered 21 for the channel number.



6. Repeat step 4 or 5 until desired channel is obtained
7. Press the **ENTER** key to change the **Duplex Group Channel#** for the UR92. DT402D throttles will need to rejoin on the new channel#

14.4.4 Configuring the Duplex Group Password

The UR92 ships from the factory with the default Duplex Group password of 0000, *the value that disables password requirements*. You may have an occasion when operating in a multi system environment when you may want to restrict access to your layout and operating system via a tetherless Duplex Throttle. The password for your Duplex Group may be activated or changed:

1. Plug a DT402D throttle into the UR92.
2. Press the **EXIT** key.
3. Press the **OPTN** key then the **EDIT** key.
4. Enter a 4-digit number using the numbers on the keypad (0001-9999). In the example below we have entered 1981 as the Duplex Group Password.

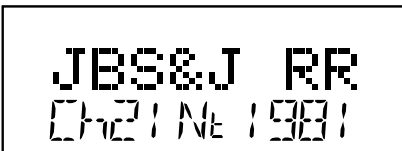

5. Press the **ENTER** key to change the Duplex Group password for the UR92. The throttle will save the new settings in the UR92 and revert to normal operation.

15.0 Advanced Operations Capabilities

15.1 Multiple Unit Operations

Digitrax command stations offers three methods of consist control:

1. **Basic Consisting**
2. **Advanced Consisting**
3. **UniVersal Consisting (the Digitrax preferred method)**

By definition, Digitrax always adds loco addresses to the “TOP” loco address in a consist.

The “TOP” loco is special, in that it is the address that receives the speed and direction commands for the entire consist.

All non TOP loco addresses added to the consist are controlled by commands sent to the “TOP” loco.

The TOP locomotive does not have to be a physical loco on the track, it can be a phantom.

Digitrax defines the TOP loco as the loco on the R Throttle Knob at the time when the MU add is performed.

All loco addresses in a consist will have the same status as the TOP loco. They will all be common, in-use or idle based on the state of the TOP loco.

Each loco within a consist maintains its original advanced 28/128 or standard 14 speed step mode setting.

A consist can be released by one throttle and then selected and run by any other throttle.

A consist TOP address can be dispatched and acquired on another throttle just like any other address. *See Section 11.0.*

15.1.1 Adding a Locomotive To A Consist

DT402 and DT402R throttles must be plugged in to LocoNet to add loco addresses to consists. DT402D may perform this without plugging in.

1. Select the loco address of the TOP loco on the **R** Throttle knob.
2. Select the address of the loco you want to consist to the TOP loco on the **L** Throttle knob.
3. Move the two locomotives into position. The locomotives can be headed in either direction. They can be adjacent to each other in the train or one unit can be the mid train helper or a pusher on the end of the train.
4. Before consisting the locos, make sure that both are traveling in the **SAME PHYSICAL DIRECTION ON THE TRACK**. (The direction indicators may or may not match, the important thing is that the locomotives are set up to move in the same direction and are not pulling against each other.)

5. Press the **MU** key, the display will show the following:

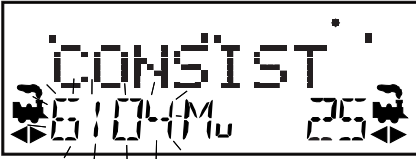

the MU mode indicator on the display is lit. The loco address in the **L** side of the display will blink to show that it is the address that will be consisted to the address on the **R** Throttle.

6. The DT402 display will prompt you to press the **Y / +** key to add the loco address or the **N / -** key to remove the loco address from the consist controlled by the TOP loco address selected on the **R** Throttle. You will see the display alternate between the following two screens to remind you of which key to press.

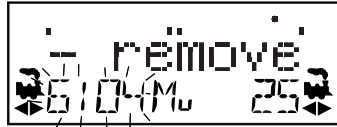

7. Press the **Y / +** key to add the left address to the consist.

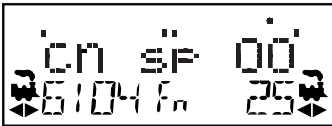

The **L** Throttle display shows the address of the loco that was added to the consist with a **cn** in the text line above it. The **R** Throttle display shows the address of the TOP loco address and its current % of full speed. The **R** Throttle is now in control of the speed and direction of both locomotives in the consist.

8. Once a consist is set up and linked to the TOP locomotive, this TOP loco can be released and selected to run from either throttle on your DT402. The consist can also be dispatched to another throttle.

You can access the functions of any loco in the consist by selecting the consisted loco to a throttle and using the function keystrokes outlined in *Section 13.0*. You will not be able to change the speed or direction of any loco that is part of a consist but is not the TOP loco, while it is consisted.

15.1.2 Removing A Loco From A Consist

DT402R and DT402 throttles must be plugged into LocoNet to remove loco addresses from consists. A DT402D may perform this without plugging in.

1. Select the loco address that you want to remove from a consist on the **L Throttle**.
2. Press the **MU** key to enter consist mode.
3. Press the **N / -** key to remove the loco address from the consist.
4. The **L Throttle** automatically becomes active with the loco you just removed from the consist. If you remove the loco from the consist while the consist is moving, the removed loco will be broken out of the consist at the same speed and direction that it was moving in the consist. You can uncouple and run the removed loco as an independent loco again!

15.1.3 Nested Consisting

The loco that was selected in the **L Throttle** to be added to the consist can itself be the “TOP” loco of another consist. When it is added to the current **R Throttle** “TOP” loco it will become a “nested” consist. In this case the whole nested consist is linked and becomes part of the new consist.

The loco that is selected in the **L Throttle** to be removed from the consist can itself be the “TOP” loco of a nested consist that was linked into the current **R Throttle** “TOP” loco. In this case the whole nested consist is removed from the consist and returned to the **L Throttle** as a consist.

15.1.4 MU of Mismatched Locomotives

If all the locomotives in the consist have performance characteristics that are closely matched, you can run all the consisted locomotives in 128 step mode. If the units are completely mismatched (for example if you are running two different brands of locos with noticeably different characteristics), then we recommend speed matching the locos by programming Loadable Speed Tables (See your Mobile Decoder Manual more information).

15.2 Sw (Switch) Mode

Switch mode is used for sending commands to accessory decoders and for changing option switches in your LocoNet system. The most common use of switch mode is for operating turnouts. When you enter Switch mode, the throttle knobs and direction keys will continue to control the loco addresses running on the throttle. Loco speed will be displayed on the bar graph and loco direction will be displayed on the direction indicators for each throttle.

15.2.1 To change the position of a switch or turnout

- 1 Press the **SWCH** key to enter Sw (switch) mode.
- 2 The last switch decoder address selected by your throttle is displayed on the text line followed by a “**t**” or “**c**”.
- 3 The display indicates the switch position using the “**t**” or “**c**” as follows:
 - “**t**” indicates that the switch is “thrown”
(for a turnout, the diverging route is set)
 - “**c**” indicates that the switch is “closed”
(for a turnout, the mainline route is set)

If the “**t**” or “**c**” indicator is flashing it means that the LocoNet Command Station does not know the current switch position. A steady “**t**” or “**c**” indicates that the command station knows the position of the switch.

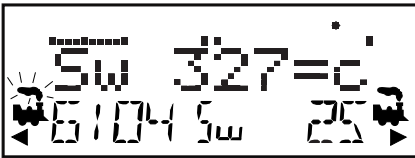

- 4 Use the numeric keypad to enter switch number and the **OPTN / t** and **CLOC / c** keys are used to tell the switch in which direction it should operate. Use the numeric keypad to enter the switch address you want to change.
- 5 Once the desired switch address appears in the text area of the throttle, you will see either “**t**” or “**c**” on the right side of the = sign in the display. If the “**t**” or “**c**” is flashing, the command station does not know the position for this turnout. Press the **OPTN / t** key to move the switch to the “thrown” position OR the **CLOC / c** key to move it to the “closed” position.
- 6 If the switch you selected is a turnout connected to an accessory decoder, it will change position from closed to thrown or vice-versa. If the switch you selected is an option switch setting for your command station, the software switch inside the command station will be changed.

7. After commanding the switch “closed” or “thrown” the switch position display will stop flashing, since the command station now knows the current switch position.
8. When you have finished your Sw (switch) operations you can return to Fn (Normal Operating Mode) by pressing the **EXIT** key or the **FUNC** key .
9. The next time you enter Sw mode, the DT402 will remember where you left off and start at the last switch address and position you accessed.

Note: that the accessory decoders in the system are accessible to all throttles or control devices with switch control capabilities and are not reserved in-use to a single throttle like locomotive decoders.

15.3 Fast Clock

The DT402 throttle can edit system functions like the fast clock and routes. Both of these features can be enabled or disabled by your command station. Digitrax command stations ship with fast clock enabled and routes disabled.

15.3.1 Fast Clock Basics

Many operators use a fast clock during operating sessions to simulate prototypical operations. Traditionally, this clock is on the wall and is set up to run at a faster than normal rate. LocoNet has its own networked fast clock for all Digitrax throttles connected to your system.

The fast clock display is a 4 digit 12 or 24 Hour format clock. To display the fast clock simply press the **CLOC / c** key. The fast clock display will remain active while you are running trains until you initiate another throttle task such as loco address selection, programming, MU, Switch mode, etc. To stop displaying the fast clock and return to the default display, press the **CLOC / c** key again. This is the display you will see:

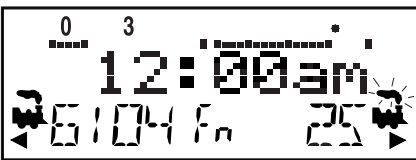

Any DT series throttle (including your DT402) that is plugged in to your LocoNet system will update its fast clock time and rate to be synchronized to the rest of the system a couple of seconds after it is connected to LocoNet.

Each DT402 can be set up with an alarm. When the current fast clock time matches the private alarm time set in any DT402, that DT402 will beep and flash the message “Alarm” to indicate that the alarm time has elapsed.

The fast clock rate for the fast clock is user selectable from 1:1 to 100:1 in steps of 1. The most popular range of values is 4:1 to 8:1.

15.3.2 Stop the Fast Clock

Setting the clock rate to 00 will stop the fast clock for the entire system at the currently displayed time. Fast time will re-start when a new non-zero rate value is set.

The current fast clock time, fast clock rate and the DT402 alarm time can be changed by using the Edit mode.

15.3.3 Edit Fast Clock Time, Rate and Alarm

DT402 must be plugged in to LocoNet to edit the fast clock settings.

1. From Fn mode, press the **EDIT** key to change to Edit Mode.
2. Press the **EDIT** key to scroll through the different things you can edit.
3. The first time you press the **EDIT** key, the mode indicator in the center of the bottom row of the display will show Ec (Edit Clock Mode) and the text area will show a 12 hour time. See Customizing Your Throttle, *Section 16.0 (12HrClock)* for setting the clock for 12 or 24 hour operation.
4. Use the Throttle knobs to dial up the “current” time. Use the **L** Throttle for hours and the **R** Throttle for minutes. You can only move time forward. Press the **EDIT** key again to set the time and move on to edit the fast clock rate.
5. When you press the **EDIT** key the second time, the mode indicator will display Ef (Edit Fast Rate) and the text will show Rate=nnn where nnn is the clock rate. Use the throttle knobs to dial up a clock rate that is between 000 and 120 (the throttle will let you dial up to 255 in this case but values above 120 have no meaning to the system). Press the **EDIT** key again to set the fast clock rate and move on to edit the throttle alarm time.
6. Once the time and fast clock rate are set, the mode indicator will display EA (Edit Alarm) and the text will show a 12 or 24 hour time. Use the throttle knobs to dial up the alarm time. Press the **EDIT** key again to set the fast clock alarm. NOTE: The fast clock alarm can't be turned off.
7. Once the time, fast clock rate and alarm are set, you will automatically return to Fn Mode unless your system is enabled for other types of editing such as routes. If you are set up for command station routes, the clock editing screens will be followed by Er for editing routes as described in the system manual for command stations that support internal routes. To exit Edit mode at any time simply press the **EXIT** key.

15.4 Route Basics

You can use your DT402 with a DCS100 to set up routes that are triggered by operating a single turnout address to make it either **c** (closed) or **t** (thrown). Setting up and operating routes is similar to consisting locomotives because you can cause more than one unit to operate based on a single command sent to the system. We call the turnout address to which other turnout addresses are "consisted" to the TOP address. To operate a route, use Sw (Switch) mode to select the TOP turnout address in the route and move it to either **c** (closed) or **t** (thrown) to initiate the route you have previously set up in your route list. The TOP turnout address does not need to be physically present on the layout, it can be a "phantom" turnout address.

The DCS100 supports up to 32 routes. Each route consists of a list that contains a TOP turnout address and its position **c** or **t** and up to 7 other turnout addresses and their positions. Routes are stored in the DCS100's memory and can be operated by any throttle in the system that can send switch commands. Each of these 32 routes is operated by setting the TOP turnout address to the position saved in the route list. When a route is triggered, a route can include a switch that is the Top of another route and all the entries in the second route will be added to the string of turnout commands the initial route request generates. The second route called is a "nested" route.

From the initial route you can "nest" up to 3 levels deep. Note that a route that itself does not contain another Top switch (i.e., another route) will not increase the nest depth. Knowing this, you can assemble up to 120 switch commands in a single route if you are careful when you set up your nesting.

If the DCS100 determines that you have exceeded these limits, it will beep 5 times to alert you to the problem. Note that if a route contains the same switch command more than once and this causes the route to "loop back" on itself, this will also generate a 5 beep route error indication and no switch commands will be issued to the layout. In this case you will need to edit the route and correct the errors in the list before trying the command again.

15.4.1 Enabling Routes

Before you can set up routes, you must set the DCS100's OpSw #26 to **c** (closed). See your DCS100 manual for instructions for changing OpSw's.

You can erase all current routes in the DCS100 by setting OpSw 37 to **c** (closed).

15.4.2 External Routes

The DS64 stationary decoder can also generate cascade switch message commands or routes independently of the DCS100's capability. See the appropriate manuals of these products for further details.

15.4.3 Edit Routes

To go to the Edit Routes (Er) mode you must pass through the clock editor:

1. Start in Fn mode. Press the **EDIT** key to enter Edit Mode.

Press the **EDIT** key again to enter Ec (Edit Clock) mode.

Press the **EDIT** key again to enter EF (Edit Fast Rate) mode.

Press the **EDIT** key again to enter EA (Edit Alarm) mode.

Press the **EDIT** key again to enter Er (Edit Routes) mode.

The DT402's display will show the following screen when you enter the Edit Routes mode.

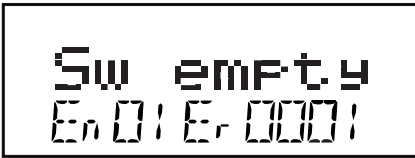

This display shows Er (Edit Routes) in the Mode Indicator area on the bottom row to let you know you are in Edit Routes mode.

The right side of the bottom row shows which route you are working with. This can be any number from 01 through 32.

The left side of the bottom row of the display shows which entry within the route you are working with. The En (entry) number can be any number from 01 through 08.

En01 is the TOP or controlling turnout address. The position, "t" or "c", that you set for this turnout address is the one that will operate the route.

The text area shows "Sw empty" to let you know that nothing has been entered for Entry 01, Route 01.

2. Use the **R** Throttle knob to dial up the Route number you want to work with. The bottom right display will show the route number. The DT402 will allow you to dial up above route 32 but please **DO NOT USE** route numbers outside the range of 01-32.
3. Use the **L** Throttle knob to dial up the Entry number within the chosen route that you wish to work with. The bottom left display will show the entry number.



This display shows Entry 01, Route 11 as empty.

4. Press the **ENTER** key and “Sw” in the text area will begin to flash, use the Throttle knobs to dial up the turnout address you want to add to the route. Use the **L** Throttle knob for 100s and the **R** Throttle knob for 10s and 1s. Once you make changes to the turnout address number or the position of that address, the entire text area will begin to flash. The key pad is not active during this throttle task even though some keys may change the display.
5. When the turnout address you want is on the screen use the **OPTN / t** key to set the turnout to **t** (thrown) or the **CLOC / c** key to set the turnout to **c** (closed).

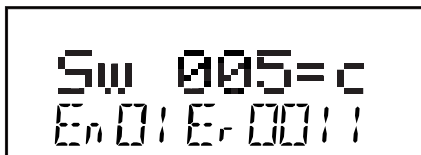

This display shows Entry 01, Route 11 with turnout address 005 set for **c** (closed). In this case address 005 is the TOP address for this route because it is Entry 01 for the Route.

6. If you don't want to make any changes to the route and entry selected, simply press the **BACK** key or either of the Throttle knobs to exit turnout address/position editing and return to selecting a different route/entry number (step 2 above).
7. Once your selection is complete, press the **ENTER** key to save the turnout address in the position selected into the route.
8. Continue entering route entries in this manner until your route is complete. You can toggle back and forth between selecting route and entry numbers and entering turnout addresses and positions by pressing either Throttle knob or the **BACK** key.
9. Once you have finished editing routes, press the **EXIT** key to exit the Er (Edit Routes) mode and return to Fn (Normal Operating) mode.
10. To operate the routes that you have set up, simply press the **SWCH** key, key in or dial up the TOP turnout address for the route and press the **OPTN / t** key or the **CLOC / c** key to issue the appropriate **t** (thrown) or **c** (closed) command. When you select the TOP turnout address in a route and the position command (**c** or **t**) you issue matches the position that is stored in the route, the route will operate. If you select the opposite position from that stored as the route, the TOP turnout address will change to that position and the route will not operate.

15.5 FIND Key and Digitrax Transponding

On layouts set up for Digitrax transponding with transponders in locos and rolling stock and transponder receivers installed on the layout, the DT402's **FIND** key is used to turn on the find command. This lets you see the zone location of transponders on the layout in your throttle display. To use the FIND Command:

1. The layout must have Digitrax transponder receivers (BDL168 and RX4s) installed and configured.
2. The loco or other rolling stock that you want to track must have a transponder installed. This can be either a transponding decoder or a stand alone transponder.
3. Select the address of the transponder you want to track on the active throttle on your DT402 (the one with the flashing smoke icon). Find can only be active for one address at a time.
4. Press the **FIND** key, the display will show a screen similar to one of the following examples:

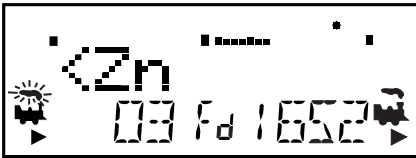

This example shows a DT402 in FIND mode for address 03 selected on the **L** Throttle. The system is not able to find address 03 so there is no display after the <Zn. Either the loco or rolling stock with address 03 is not present on the layout or it does not have a transponder or it is located in a zone that does not have a transponder receiver.

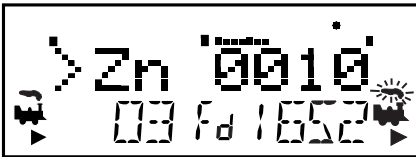

This example shows a DT402 in FIND mode for address 1652 selected on the **R** Throttle. The system sees address 1652 in Zone 0010 moving at about 50% of full throttle. When address 1652 moves to another Zone, the display will automatically update to show the new Zone location.

5. Find will remain active until you press the **FIND** key again to disable find mode.

16.0 Customizing Your Throttle - Step-by-Step

16.1 Changing the Throttle Options

You can change the option settings for each DT402 throttle to customize the way it operates. Option setting changes can be made on your DT402 either tethered into the LocoNet for power or untethered with a battery installed.

Following the instructions on accessing the Options menu is a chart listing, in menu order, the Option name as it appears in the DT402 display, a brief description of the Option and the factory default for each. There is also room on the chart for keeping track of your changes to the default settings.

The **FactoryD** option allows you to easily set the DT402 Options all back to factory defaults. To change the settings:

1. Press the **OPT / t** key to access the Options menu.



2. Use the **R** Throttle to scroll through the Options. They are in the same order as the following charts. The Option names will blink during this part of the process.
3. Use the **Y / +** or the **N / -** key to toggle through the values for each option until the desired value appears on the screen.
4. To change another option, repeat steps 2 and 3.
5. Press **EXIT** key at any time to cancel all of your changes
6. When you are satisfied with the changes, press the **ENTER** key to set all of the changes at once.
7. You can return to the factory defaults by resetting the last option, FactoryD to On and pressing the **ENTER** key.

Note: If you change the IR, Simplex RF or Duplex options you will need to power cycle the throttle after pressing the **ENTER** key so the new options are reloaded. Unplug the throttle, remove the battery and then repower to complete this startup re-configuration.

DT402 Option Screen	Description	Options (Default in Bold)	My Setting
IR mode	On enables IR mode when disconnected and IR receiver detected on LocoNet	Off On	
RF1 mode	On enables Simplex radio (for DT402R)	Off On	
Clicks	On enables clicking when making any key-pad or knob changes	On Off	
Fclock	On enables Fast Clock i center display	Off On	
12HrClock	On selects 12Hr vs 24Hr clock display mode	On Off	
NoBlstic	Off provides rate-sensitive knob steps so faster turning gives bigger step changes	Off On	
STimeout	On shortens the amount of time before the throttle kicks into Power Save when no changes have taken place	On Off	
F3Static	On makes F3 key On/Off action	On Off	
F2 Mom	On makes F2 key momentary action	On Off	
F2Analog	On enables optional F2 key pressure-sensitive analog mode for use with playable whistle feature	Off On	
MsgFilter	On stops throttle messages from displaying when selecting locomotives	On Off	
SLFollow	On enables slot following mode for locomotives selected in multiple throttles	On Off	
ES->Idle	On (Global Stop) stops all locomotives when Emerg-Stop key pressed. Off (Local Stop) stops only locomotives selected in throttle	Off On	
PWRSaver	On enables Radio/IR mode power save on throttle inactivity	On Off	
IRRelease	On allows IR/Simplex locomotive release when untethered	Off On	

DT402 Option Screen	Description	Options (Default in Bold)	My Setting
DplxBad	On enables white flashlight LED to blink when repeated Duplex radio messages fail.	On Off	
DxRxLPwr	On enables maximum Duplex power saving. Disables slot following updates.	On Off	
NewTypes	On allows throttle to override command station new-type loco speed step settings	On Off	
Nu Type=	128 speed step setting 14 speed step setting reserved 28 speed step setting Advanced 128 speed step setting reserved Advanced 28 speed step setting	128 14 tR1 28 128A RES 28A	
Recall#	Recall stack set at last 4 entries Recall stack set at last 8 entries Recall stack set at last 16 entries	RC04 RD08 RC16	
BackLite	Maximum backlight brightness-highest power consumption Maximum backlight brightness-lowest power usage	2 MAX 1 MIN	
RF1 Freq	RF1 channel- info only	A B	
Throt ID	Optional unique throttle ID#	427F	
XPFnHold	On allows multiple expanded function keys per X1 or X2 choice	On Off	
XP Slots	reserved	On Off	
Duplex RF	On enables RF24 to operate in Duplex mode. Off turns off Duplex choice	On Off	
FactoryD	Select ON and press ENTER key to force all options settings to factory defaults	On Off	

17.0 Programming Configuration Variables (CVs)

The decoders installed in your locomotives provide you with the ability to create a more realistic operating experience through the configuration variables (CVs for short). The DT402 series throttles support configuration of up to 1024 CVs!

It is a good idea to run your decoders with the default CV values that come pre-programmed in your decoders until you get used to the performance characteristics and how they work on your layout. Once you are comfortable with running the trains, then you can begin customizing loco characteristics.

Each CV (configuration variable) controls a specific characteristic of the decoder, which in turn controls how the locomotive performs. See your decoder manual for a list of the most commonly used CVs and their meanings.

Each decoder comes pre-programmed from the factory with the default settings outlined in your decoder manual. You can change your decoder's performance characteristics by changing the CV values entered in the CVs you want to change. Each of these CVs can be set up when your command station is in the programming mode. The CVs are remembered in the decoder until it is reprogrammed to with a different CV value. Please refer to your Digitrax Mobile Decoder Manual for a complete listing of the CVs supported by each decoder.

Important Note on Programming:

Programming decoder CVs is most commonly and easily done on an isolated programming track and the following examples use that method. *See Section 6.1 for details on setting up the programming track.*

Simplex Radio and infrared throttles must be plugged into LocoNet to program CVs on the programming track. Ops Mode Programming can be done without plugging simplex radio throttles into LocoNet. IR throttles must be plugged in for Ops Mode Programming. Duplex throttles can program without plugging in on both the programming track and in Ops mode.

The latest information on Digitrax Decoders is available online for download at **www.digitrax.com** in the Manuals and Instructions section.

17.1 Programming Mobile Decoder Addresses

1. Be sure that only the loco you want to program is on the programming track (see Section 6.1). If you are using operations mode programming, the loco you want to program can be anywhere on the layout but it must have a decoder that is capable of ops mode programming installed.
2. Press the **PROG** key to enter programming mode. The DT402 will display the following to show you are in the Program mode:

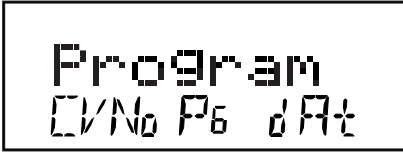

“CVNo” on the left side indicates that configuration variable numbers will show on the left and “dAt” on the right side indicates that CV values or data will show on the right side of the display.

The mode indicator in the center of the bottom line of the display shows which programming mode the throttle was using the last time it was in programming mode. Press the **PROG** key to cycle through the following options:

P_G = Paged mode (Digitrax Preferred Programming Mode)

P_H = Physical register mode

P_d = Direct mode

P_o = Operations mode (See your Command Station manual).

3. After a few seconds, the display will display the last CV and CV Value you programmed. If the display does not show Ad2=???, turn the **L** Throttle knob counterclockwise until you see Ad2 in the left side of the display:

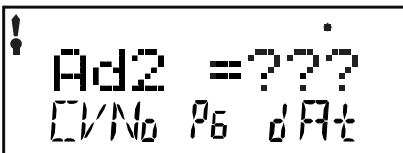

4. If you want to program a 4-digit address, press the **R** Throttle knob once to change the display to:

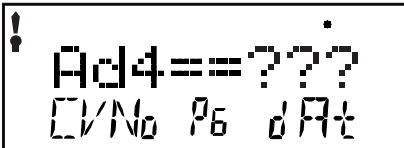

You can toggle between 2- and 4-digit address programming by pressing down on the **R** Throttle knob.

- Use the **PROG** key to select which programming mode you wish to use. Press the **PROG** key to toggle between PG, PH, Pd, and PO. Digitrax recommends using the Pd, or Direct mode for programming all Digitrax decoders when using service mode on the programming track.
- To program a 2-digit address, use the **R** Throttle knob to dial in the address or use the keypad to enter the address. In the example below we have pressed the 3 and 9 keys to enter the loco address, 39. Press the **ENTER** key to program the decoder.

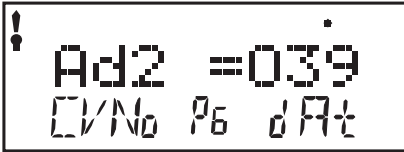

Note, when programming a 2-digit address, the decoder automatically enables 2-digit addressing.

- To program a 4-digit address, simply enter it on the keypad. In the example below we have simply pressed **9, 9, 8, 3**, on the keypad to enter the loco address, 9983.

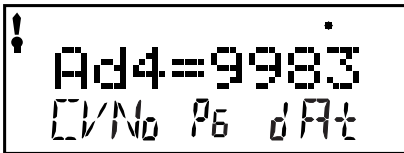

Alternatively, you can use the DT402's Throttle Knobs to dial in the 4 digit address you want to program. Use the **L** Throttle to dial up 1000s and 100s and the **R** Throttle to dial up 10s and 1s. Press the **ENTER** key to program the decoder

- When the **ENTER** key is pressed, the throttle will beep and display Ad2=0wr or Ad4=0wr followed by a blinking square during programming. If you programmed a 2 digit address, you can proceed to the next section to program other CVs or you can exit programming mode and run trains.
- If you are programming a 4-digit address, there is one more step: the throttle will display Ad4on?=y. Press the **Y / +** key to enable the 4-digit address and automatically set CV29 to the value of 038. The display will show the 4-digit address that you just programmed and enabled.

10. Press the **EXIT** key to quit programming mode and return to normal operations. Or if you want to continue programming additional CVs, see the next section.
11. If your command station is a DB150 and you are using any method other than Operation mode for programming, you will need to turn track power back on after you complete programming. Press the **PWR** key, then press the **Y / +** key, then press the **PWR** key to exit power mode. The DCS50 and the DCS100 do not require this step.

17.2 Programming CVs Other Than Addresses

There are 1024 different CVs that have been defined to handle many characteristics you might want to use for your locomotives. Your decoder manual has a complete listing of CVs that are available in specific decoders, what they do and suggested values for each CV.

1. Place the decoder equipped locomotive you want to program on the programming track. If you are using operations mode programming, the loco you want to program can be anywhere on the layout but it must have a decoder that is capable of ops mode programming installed.
2. Enter Program Mode by pressing the **PROG** key. The display will show the last CV and CV Value you programmed. In the case below, it is the last loco address

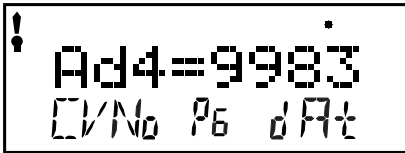

3. Select the programming mode you wish to use by pressing the **PROG** key until the method you want appears in the Mode Indicator. Digitrax recommends using the Pd, or Direct mode for programming Digitrax decoders when using service mode on the programming track.
4. Turn the **L Throttle** to begin selection of the CV# you want to program.

You will see the **!** icon displayed on the left of the DT402 display when you are entering CV Numbers. You can dial up the number using the **L Throttle** or you can use the keypad to enter CV#s 01 through 1024.

- Press the **R** Throttle to activate the CV value. You will see the **!** icon displayed on the right of the DT402 display when you are entering CV Values. Use the **R** Throttle to dial up or the keypad to enter the CV value you want. CV values are displayed as decimal numbers (0-255) by default.

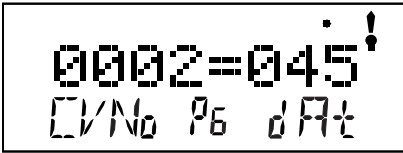

Remember that you can press the **R** Throttle knob to toggle the CV value display between decimal and hex as shown below.

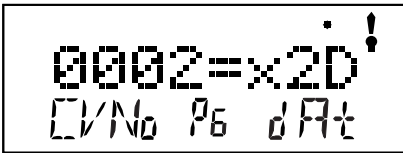

- Press the **ENTER** key to program the selected CV value into the selected CV number.
- Press the **EXIT** key to quit programming mode and return to normal operations. You can program as many CVs and their values as you want in a session. When you are finished, press Press the **EXIT** key to quit programming mode and return to normal operations.
- If your command station is a DB150 and you are using any method other than Operation mode for programming, you will need to turn track power back on after you complete programming. Press the **PWR** key, then press the **Y / +** key, then press the **PWR** key to exit power mode. DCS100 does not require this step.

17.3 Operations Mode Programming

Operations mode programming lets you program CVs in decoder equipped locomotives equipped with Extended Packet Format decoders while they are on the mainline. A typical use for Ops mode programming would be to change the acceleration rate (CV03) or the deceleration rate (CV04) of your locomotives to simulate the weight and braking capability of the train to compensate for changing the number of cars or power units on a train.

Your DT402 can use ops mode programming to change the CV value in ANY CV, including 2-digit and 4-digit addresses.

Ops mode programming can be performed by any DT402 at any time since the throttles are not competing for usage of the single programming track.

DT402 throttles must be plugged in for Ops Mode. DT402D and DT402R throttles can do Ops Mode Programming wirelessly.

When you enter programming mode with a DT402R, Ops mode is the only programming mode that will be available unless you plug in to LocoNet.

How to use Operations Mode Programming

1. Select the loco address that you want to program on either the **L** or **R** Throttle. Be sure that the address you want to program is the active throttle, the one with the blinking smoke when you enter programming mode.
2. Enter Program Mode by pressing the **PROG** key to enter programming mode. The display will show the last CV and CV Value you programmed.
3. Press the **PROG** key until the “Po” appears in the Mode Indicator area of the display. If you are using an untethered infrared or radio throttle, the display will automatically show Po. The DT402 display will show the address that was selected on the active throttle in the right side of the bottom line of the display. This is the address that you are preparing to program.
4. Use the **L** Throttle knob to dial up the CV you want to modify. Use the **R** Throttle knob to dial up the CV value you wish to program for the CV. The example below shows CV04 set to a value of 003 for loco address 597.

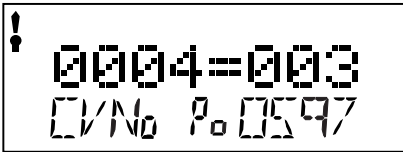

5. Press the **ENTER** key to program the selected CV value into the selected CV number. You can program as many CVs and their values as you want in a session.
6. Press the **EXIT** key to quit programming mode and return to normal operations.
7. With ops mode programming, the command station does not turn off track power. If you are using a DB150, you do not need to turn track power back on after programming with ops mode like you do with service mode programming.

17.4 Busy or Fail Message

If you get a “Busy” message in response to any programming task, the system is temporarily busy and you will have to try the task again until you get a “Good” response.

If you get a “Fail” message in response to any programming task, check to be sure that there is a loco on the programming track and that the programming track is powered.

To end a programming read back that is taking too long, simply press the **BACK** key.

17.5 Reading Back CV Values Programmed

DCS100 and DCS50 command stations allow read back of the configuration variable values programmed into your decoders. Since you must use the programming track for this, DT402 and DT402Rs must be plugged into LocoNet to read back CV and their values. The DT402D can read back while not plugged in.

Systems with a DB150 command station are not able to read back CV Values programmed into decoders.

1. Place the decoder-equipped locomotive you want to program on the programming track. You can also do an ops mode read back with Digitrax transponding decoders if you have a LocoNet device that allows ops mode read back plugged in to LocoNet.
2. Enter Program Mode by pressing the **PROG** key to enter programming mode. The display will show the last CV and CV Value you programmed.
3. Select the programming mode you wish to use by pressing the **PROG** key until the method you want appears in the Mode Indicator. You can read back in PG, PH, Pd, or Po modes with the following restrictions:

PG - Paged Mode no restrictions

PH - Physical Register Mode can only read CV01-CV08. You should not rely on values in the display for CVs above 08 when reading back in physical register mode.

Pd - Direct Mode no restrictions

Po - Operations Mode read back can only be used with Digitrax decoders that are capable of ops mode read back when there is a device attached to LocoNet that supports ops mode read back. Digitrax transponding decoders and DCS100 would allow ops mode read back.

4. To read back the CV value programmed for the *two-digit address*, use the **L** Throttle knob to dial up Ad02 (CV01) on the left side of the text area and then press the **DISP** key. The text area will show Ad2=rd followed by a flashing box. When the read back is finished, the CV value (the 2-digit address) will be displayed on the right side of the text area.
5. To read back the *4-digit address* that is programmed into the decoder use the **L** Throttle knob to dial up Ad02 on the left side of the text area, then press the R throttle knob to change to Ad4. The text area of the display will show Ad4=???? (disregard any value that appears at this time). Press the **DISP** key and the display will change to Ad4=8rd followed by the flashing box. When the read back is finished the 4 digit address will be displayed on the right side of the text area.

6. To read back any other CV start at AD2=??? (Use the **L** Throttle knob to dial in Ad2 on the left side of the display or if you were in four digit addressing, press the R throttle knob once). Use the **L** Throttle knob to dial up the CV you want to read back or use the numeric keypad to enter the CV Number. Press the **DISP** key the display will show the CV number=rd followed by the flashing box. When the read back is finished, the CV value for that CV will be displayed in the Right side of the text area.
Note: You can abort any read back in progress by pressing the **BACK** key.
7. Once you have read back any CV, you can change its value by dialing in the CV value you want and pressing the **ENTER** key.
8. Press the **EXIT** key to quit programming mode and return to normal operations (Fn Mode). You can read back and re-program as many CVs and their values as you want in a session. When you are finished, press Press the **EXIT** key to quit programming mode and return to normal operations.

18.0 How the DCS100 Manages Addresses

Your command station has a finite number of “slots” available in its memory. The factory default is set for 22 addresses. Once the slots available in your command station are full, the system will display the “slot=max” or “FF” message to let you know that you need to release some locos if you want to select and run others. *See Section 9.0 (OpSw 44) for details on changing the default value and for how many slots the DCS100 command station can handle.* The section also explains how your command station handles purging of addresses from the system to allow for more addresses to be selected and run.

18.1 Purging of addresses:

Purging is the process by which the DCS100 changes the status of decoders that are either not being used or are unattended to make room for other addresses to be selected and refreshed by the command station. *See Section 9.0 for setting the DCS100 OpSw to purge addresses.*

19.0 Decoder Status

The command station assigns status codes to each locomotive address in the system. Addresses are either selectable or not selectable. Decoders are not selectable if they are in-use on another throttle or if they are part of a consist. If you try to select an in-use address, you will be prompted to “Steal” the address. If you select a decoder that is part of a consist, you will be able to send function commands but you won’t be able to control its speed or direction. The text line in the DT402 display will show “top”, “cn” or “mid” if the address is part of a consist, otherwise it will show “stat”. This display is followed by the status code for one of the following modes of operation.

Display	Meaning
28	28 Speed Step Mode
14	14 Speed Step Mode
128	128 Speed Step Mode - Digitrax Preferred Mode
*28 FX	28 speed step-enable advanced consist mode
x01	Reserved, Do not use
x02	Reserved, Do not use
*128 FX	128 speed step-enable advanced consist mode

Status editing is used most often when you are running non-Digitrax decoders that do not have 128 speed step capabilities. If you can’t get a non-Digitrax decoder to work on your layout and you are sure you are using the correct address for the decoder, you probably need to status edit it to run in 14 or 28 speed step mode.

19.1 Status Editing a Decoder

1. Press the **LOCO** key to enter address selection mode, the display will begin flashing the address on the active throttle and will display “Sel Loco” in the text area to prompt you to select an address. Lo will also be flashing.
2. When you use the Throttle knobs or key pad to enter the address of the locomotive you want to select, the display will show the current status of the decoder. To display the status code of the loco address that is flashing in the display when you enter selection mode, just turn the throttle knob up one address and then back to the original address and the status code will display on the Display.

- To change the status of the decoder simply press the **EDIT** key the flashing Lo will change to SE and the current status code of the address will be displayed. Use either Throttle knob to scroll through the status codes shown in the table above.

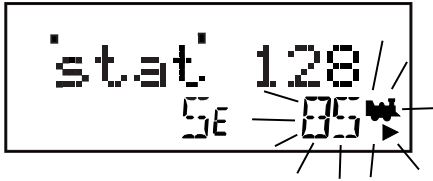

- Once the status code you want to use for the address is displayed in the text area of display, press the **ENTER** key to change the status code of the locomotive and to select it to run on the active throttle knob.
- If the loco address is in-use on another throttle or in a consist when you press the **ENTER** key to complete the status edit process and select the loco on the active throttle, the DT402 will prompt you to Steal=Y. If you want to steal the address, press the **Y / +** key to complete the status edit. If the loco is part of a consist, it will not be selected and will remain part of the consist when the status is edited.

19.2 Note for Non-Digitrax Decoder Users

If you have a decoder that does not have advanced 28/128 speed step mode available, you must “status edit” that locomotive to standard 14 speed step mode before running it with your Digitrax system. Changing the decoder’s status will cause the system to handle this decoder as a 14 step decoder. Status editing does not reprogram anything in the decoder.

20.0 UR92 Additional Information

20.1 Advanced UR92 Installation

Adding UR92s will provide better signal coverage for complex layouts. If you are adding more than one UR92 be sure to connect all of the units to LocoNet before changing the Duplex Group name or channel number. This will prevent the units from automatically re-negotiating these values with each addition.

- Add the UR92(s) to your LocoNet. (See UR92 Installation section.)
- After adding extra UR92s, use the DT402D to turn OFF layout track power and then turn track power back ON. This forces all the UR92s to automatically negotiate a common Duplex Group name and channel number. (Your Group name may change with each UR92 addition.)
- Rejoin the DT402Ds by either the tethered (described above) or untethered method (described in the DT402 manual) to use the newly established Duplex Group name and channel.

Setting Duplex Group Name: You can use the DT402D to edit the UR92's Duplex Group name to one you choose. This change is optional, and the UR92 factory default will work out of the box with no change. You should have all UR92s connected to the layout before changing the Duplex Group Name or they will automatically renegotiate and may change the preferred name to a default.

1. Connect the DT402D to the front RJ12 jack of any UR92 on the LocoNet.
2. On the DT402D press the **OPTN** key and then the **EDIT** key.
3. The 8 character Duplex Group name will appear in the display center.
4. Use the **R** Throttle knob to change the first character value. It will blink as it is changed. When the desired character is seen, use the **L** Throttle knob to move across and select a character to modify.
5. Press the **ENTER** key to update the current displayed characters as the new UR92 Duplex Group Name. To skip making any changes, simply press the **EXIT** key.
6. After changing the Duplex Group Name, your other DT402Ds will need to rejoin to use this new Group Name. **Note:** As long as Duplex Group Name is unique, it is generally possible to run dozens of different layouts on the same channel number in close proximity.

Setting the Duplex Group Channel: You can use this capability to move the duplex channel away from signal interference caused by other devices.

1. Connect the DT402D to the front RJ12 jack of any UR92 on LocoNet.
2. On the DT402D press the **OPTN** key and then the **EDIT** key. The Group channel number (11-26) will now show in the lower left hand side of the display.
3. Use the **Y / +** key to change to a higher channel in the available range of 11 through 26. The **N / -** key will change to a lower channel.
4. Press the **ENTER** key to update the currently displayed channel as the new UR92 channel to be used with the Duplex Group Name.
5. After changing the channel all DT402Ds will have to rejoin to use this new channel. To skip making any changes, simply press the **EXIT** key.

Note: If you suspect a Wireless LAN or other device is causing interference and limiting range, you can change the channel as above, and search through all available 16 channels to find one that gives the best coverage.

See additional resources at www.digitrax.com. There are additional utilities to let you scan the layout environment for any signals using the installed UR92's as scanners and to easily update your Duplex Group name, channel and to set up a Password to protect your Group from unauthorized access.

20.2 Troubleshooting UR92 Installation

To get the best performance from your duplex radio installation, walk around

the layout and check Duplex operation for adequate signal coverage.

Depending on the layout size, geometry and surrounding materials it is often possible to move the UR92(s) to better cover dead spots. Experimenting with UR92 location will usually help you locate a position that is best for your layout. Note that DT402D orientation and body position of you and your operators may also affect the UR92's range and reception.

On very large layouts or layouts with problem areas, it is possible to add more than one UR92. Adding extra units will automatically provide space-diversity coverage and reliability. Adding multiple UR92s is covered in the Advanced Installation and Customization section of these instructions.

If duplex range is poor, it may be due to interference from a Wireless LAN or similar device operating continuously on the same channel. The next section outlines several ways to avoid interference and congestion from other devices.

20.3 Resetting UR92 To Factory Defaults

You are unlikely to encounter a problem that will require a factory reset. One such instance may occur if you set a Password for your Duplex Group Name and forget what it is. Resetting to factory default condition is an easy way to correct the situation.

1. Disconnect the UR92(s) from the LocoNet. If you have more than one UR92 in your layout, you must disconnect all of them to do a full factory reset on each unit as follows.
2. Disconnect any throttle that is plugged into the UR92.
3. Leave the PS14 power supply connected to the UR92 and to the wall outlet.
4. Press and hold the button (next to the power supply jack) for two seconds or until both the red and green LEDs begin to blink. Release the button.
5. When the lights stop blinking, unplug the power supply.
6. Reconnect the PS14 DC power supply to the UR92. The green and red LEDs will blink and then the red LED will stay on.
7. Connect the UR92 to your working LocoNet system using one of the RJ12 jacks at the rear of the UR92. The red LED will go off and the GREEN **RADIO** LED will blink at a 2-second interval to indicate that it is set up for duplex radio operation and is working.
8. The UR92 is now set to the factory default Group Name of Dtxnnnn (where "nnnn" is the unit serial number) and Channel 11.

21.0 Troubleshooting Problems

21.1 I'm lost!

If your DT402 display isn't showing you what you expect based on the manual, press the **EXIT** key to return to normal operating mode Fn. Then try the throttle task again.

21.2 Runaway train or layout!

- Press the **PWR** key followed by the **N / -** key, OR
- Flip the MODE switch to “SLEEP” on the DCS100 Command Station.

Either way, the layout will stop to give you a chance to regain your composure.

To resume operations where you left off

- Press the **PWR** key followed by the **Y / +** key, OR
- Flip the MODE switch to “RUN” on the DCS100 Command Station.

21.3 Nothing is responding

Is track power turned on? Is your throttle in Idle or stopped and displaying a flashing TRACK POWER indicator and Trk=Idle in the throttle display?

Press the **PWR** key followed by the **N / -** key then **Y / +** key then **PWR** key to toggle the track power off then on. You should see the TRACK POWER indicator on the DT402 come on solid.

21.4 Can't select a loco on my throttle

Is the loco in use by another throttle

Did the throttle ask you “STEAL=Y?”.

Is the loco part of a consist?

Do you see a cn in the display when you try to select it? A loco in a consist cannot be selected and run separately. You can still control some Functions.

Have you changed the loco address?

You can read back the loco address to see if it has been changed. *See Section 17.5.*

Does your throttle say “slot=max”?

This means that the system's capacity to handle operating locos is full. The DCS100 default setting can run up to 22 addresses at the same time. If you have the “slot=max” message, be sure that all locos that are not running are released from throttles or set DCS100 OpSw 44 to “c” (closed) to increase the number of addresses to 120. *See Section 9.0 for setting OpSw. A quick way to free up slots when using the DT402 throttle is to address a loco you've been running and then press the EXIT key. As an example, the key sequence LOCO-1-1-8-EXIT releases loco address 118 from the system and thereby frees a slot.*

21.5 Clean Track

The majority of intermittent operation problems can be traced to bad connections and poor or noisy wheel pickups on locomotives. Check track cleanliness and quality of wheel pickups.

21.6 The Quarter Trick

If your track does not have adequate power supply to the locomotives, then the signal won't get through either. Take a quarter or screwdriver blade and go around your layout creating electrical shorts every 10 feet. Your DCS100

should beep 4 times and shutdown when the short is present. When the short is removed, the booster should beep once within 2-3 seconds and return to normal operation. If this does not happen, then you need to add more feeders. *See Section 6.3.*

21.7 The LT1 Tester

Check your LocoNet cables with the LT1 tester to be sure you don't have any cables that were made incorrectly. *See Section 5.8.*

21.8 Decoder Won't Respond

Is the loco on powered track?

If the TRACK POWER indicator on the DT402 is off or flashing, press **PWR** key and the **Y / +** key to turn on track power.

Use the "Quarter Trick" above to test for track power at several locations around the loco. If there is not track power, check your layout wiring.

Can you select the loco on your throttle?

If not, is the loco in use by another throttle or is it part of a consist (do you see a cn in the display when you try to select it)? *See Section 11.0.*

Do the settings in CV29, the configuration register, match the command station output?

If your decoder is a 14-step decoder running on any Digitrax system using factory defaults, status editing will be needed for that decoder. *See Section 19.1.*

Have you reset any CVs since the last time you ran the loco

If so, go back and change them to their default CV values and then try to run the loco. It is possible to set acceleration so high that it will take 10 minutes for the loco to start moving. To reset to factory default, see the Decoder Manual for a full listing of CVs.

Was the loco running just before it stopped?

If the decoder is very warm it may be in thermal shutdown. Let it cool off and see if it starts again. Also check for localized track problems. *See Quarter Trick on previous page.*

Are there burn marks on the decoder?

You'll need to send it in for repair!

If all else fails, reprogram the decoder address and reset CVs to default values.

21.9 "Strange" Locomotive Lights

If you can't control the operation of the lights in your locomotive with the DT402 (in default 128, or 28 speed step mode), be sure that the decoder is programmed in advanced 28 speed step mode.

Do this by programming CV29 with a value of 06. *See your Decoder Manual for more information about programming decoders.*

Glossary

128 Speed Step Mode: the motor voltage/speed curve of the decoder equipped loco from stop to full speed has 128 discrete speed steps. This means that you have 128 discrete speed steps at your disposal for excellent speed control, especially at very low speeds. 128 speed step operation will give a significant improvement in speed control over 14 or 28 step operation.

2-Digit Address: decoder address between 01 and 127 which is expressed as a 2 digit number. Addresses above 99 are expressed as hexadecimal numbers. The DT402 translates these numbers into three digit numbers 100-127. Technically a 2 digit address is a 7 bit address and is the baseline packet format for DCC addresses. It is sometimes called the short address.

4-Digit Address: decoder address between 0128 and 9983. Not all 4 digit addresses in this range are actually available for use. Your DT402 can access 0128 through 9983. Digitrax handles addresses below 0128 as two digit addresses to avoid confusion. Technically a 4 digit address is a 14 bit address and is considered an extended packet format DCC decoder address. Sometimes this is called the long address.

+: plus or add, used to increase speed or other numbers in DT402 display. Also used to add loco addresses to consists.

-: minus or remove, used to decrease speed or other numbers in the DT402 display. Also used to remove loco addresses from consists.

AC or Alternating Current: An expression used to describe an electrical wave form that cycles or alternates above and below 0 volts. In the U.S., household electricity is 60 cycle, alternating 60 times a second, 110-120 volts.

Acceleration: The rate at which the decoder increases from one speed step to the next in response to a new increase speed command. Use CV03 to set this value for each decoder. This feature is used to simulate train weight and to cause your model to respond more prototypically when you increase the throttle.

Active throttle: Digitrax DT throttles are actually two throttles in one. Each handheld can control two different addresses or consists at a time one on the right side or R Throttle and the other on the left side or L Throttle. The DTs display is shared by the two sides of the throttle. The side for which information is currently in the display is called the active throttle.

Address, Decoder: an identifying number programmed into a particular mobile or stationary decoder. The system uses the decoder address to send commands to the appropriate loco or accessory decoder.

Address Range: Analog address range is 00. 2 digit address range is 01-127, 4 digit address range is 0128-9983.

Advanced (EPF) Consisting Method: consist information is stored in each decoder. Locos can be added to and deleted from the consist in any orientation. This method requires that all locomotives in the consist be equipped with decoders that support this feature (EPF decoders). This method lets you set up a consist that is “transportable” from one layout to another. The problem is that you must be sure to put the locos back on the track in the same order and orientation you programmed them for or you can get some unexpected results.

Advanced Mode (28 Speed Step Mode): the motor voltage/speed curve of the DCC loco from stop to full speed has 28 discrete speed steps. This means that speed control will be limited to 28 steps. 28 speed step mode gives fine speed control. Increasing to 128 speed step operation will give a significant improvement in speed control, especially at very slow speeds needed for prototypical switching operations. Advanced mode is offered in most command stations because there are decoders on the market that are not capable of 128 step mode operation.

Analog Loco: A locomotive operating on a DCC layout without a DCC decoder installed. Also called a Conventional Loco.

Analog Mode Conversion: When a Digitrax decoder does not see DCC packets on the layout it changes automatically to DC operation. Not all DCC systems support this feature so you may have to program non-Digitrax decoders to operate on analog layouts. Automatic analog mode conversion can be disabled by programming CV29.

Autoreversing: a feature of Digitrax boosters that allows a train to enter and exit reversing sections automatically without the need for the operator to throw a switch to match track polarities on either side of the reversing section.

Ballast Lamp: For use as a buffer between DC and DCC track sections, a ballast lamp is connected across one of the double gaps separating the two track sections. For most model railroad applications a 12 volt automobile brake lamp wired in series is used for this purpose.

Basic Consisting Method: Program all the locomotives in a consist to the same address and run them on one throttle. In this case all the locos must be running in the same direction unless you have set up normal direction of travel as reverse or have rewired the motor on locos that you want to run “backwards” in the consist.

Booster: Boosters receive the control signal from the Command Station, ampli-

fy it and put it on the track as the power that runs the locos. You can have several boosters on a system, each driving its own track section. You can have both regular or auto reversing boosters depending on your needs. Also called Power Booster, Power Station.

Browsing: scanning sequentially through locomotive or accessory decoder addresses and statuses in you throttle. Browsing is done with the DT402 by turning the throttle knobs or using the Y+ or N- Keys.

c: closed, indicates that the turnout is in the straight through position, set for the mainline. For op switch set ups, consult your manual for the meaning of c and t.

Cab: See Throttle.

Command Station: Most systems have one Command Station that generates the commands that are sent to the decoders. The command station also produces Rail Sync so that all the devices on your LocoNet work together.

Common (Loco Status): a locomotive that is not currently “in-use” by a throttle connected to LocoNet but is still being refreshed by the command station. A loco with a status of “common” is selectable by any throttle on LocoNet.

Common Rail Wiring: A wiring system in which one side of all the track power supplies are connected. The common rail concept simplified block wiring in conventional DC systems, but is not recommended for DCC wiring. (see Direct Home Wiring).

Compatibility: the ability of equipment made by various companies to operate together on the same layout. DCC compatibility extends to decoders and boosters but not to throttles, command stations, system architecture and advanced features that are not DCC related.

Complete Train Control: the integration of many technologies including DCC for total layout control. Since DCC covers only limited aspects of layout control, the hybrid Digitrax Complete Train Control goes beyond the basics of DCC to provide you with a total layout control system.

Configuration Register (CV29): this special CV controls several different decoder characteristics including:

1. Whether the decoder uses standard 14 speed step mode or advanced 28/128 speed step mode
2. Whether or not the decoder will automatically convert to DC operation when no DCC signal is present.
3. In the case of Digitrax FX decoders, the normal direction of loco-

tive travel

4. Whether the decoder uses loadable speed tables and
5. Whether the decoder uses the 2 digit address or the 4 digit address.

Configuration Variables (CVs): these are special storage locations or “pigeonholes” in your decoders. By programming values into various CVs, you can control each decoder’s performance characteristics. CVs store information like the decoder’s address, start voltage, mid-point voltage, loadable speed tables and many more. Once you have programmed these characteristics, the decoders “remember” them until you change them again. The NMRA Standard and RPs define the usage of many CVs while others are defined by manufacturers.

Conformance Seal: issued by the NMRA after a product has passed the tests established and administered by NMRA volunteers to “prove” that a particular product follows exactly to the letter the Standards and RPs set up by the NMRA that pertain to that product. Conformance seals do not insure interoperability or the quality of the products, only manufacturers provide warranties on the equipment they sell.

Consisting: linking more than one locomotive together to be controlled by a single throttle and or address. Also called multiple unit operation, MU’ing, multiple unit lash ups, etc.

Constant Brightness Lighting: because DCC runs with constant track voltage, locomotive lights stay on even when the loco is not moving, just like the prototype.

Conventional Loco: A locomotive operating on a DCC layout without a DCC decoder installed. Also called an Analog Loco.

DCC: Digital Command Control.

DC or Direct Current: An expression used to describe an electrical wave form in which the voltage remains more or less at a value above or below 0 volts. DC is used by most model railroad locomotives. Sometimes referred to as Analog.

Deceleration: The rate at which the decoder decreases from one speed step to the next in response to a new decrease speed command. Use CV04 to program the deceleration value for each decoder. This feature is used to simulate train momentum so that, just like the prototype, your model won’t stop immediately when the brakes are applied.

Decoders, Mobile: the electronic device installed in each locomotive that

receives the signal from the command station through the track, decodes it and tells the loco what to do. Mobile decoders can also include function control, speed stabilization (back emf), transponding and other features.

Decoders, Stationary (Accessory or turnout): the electronic device for the turnouts or other accessories that receives the signal from the command station through the track, decodes it and tells the turnout/accessory what to do.

Decoder Status: the Digitrax command station assigns each decoder a status based on whether it is new to the system, in-use on a throttle, common in the system and available for selection or idle. The decoder status determines how the system treats that address.

Direct Home Wiring: A wiring system in which the DCC booster powers each rail through an individual conductor or wire. Each booster is wired to its own power district and there is no common connection between boosters. Digitrax strongly recommends direct home wiring.

Direct Programming: A type of service mode programming.

Directional Lighting: loco lights can be set up to automatically change so that the forward lamp is lit when the loco is moving forward and the reverse lamp is lit when moving in reverse.

Dispatching: use your DT throttle to set up a loco or consist you want to be run by another operator and then using a couple of keystrokes, dispatch the loco from the DT throttle and acquire it on the other throttle.

Duplex Transceiver. two way radio operation allows a duplex equipped throttle to send and receive information to the command station via a radio transceiver while not plugged in to the LocoNet.

EPF or Extended Packet Format: an extension of the baseline DCC format that allows us to use four digit addressing and other expanded decoder features.

Fn: Shorthand for Function

F0: Shorthand for Function 0. F0 is two functions in one. F0 Forward controls the white function lead and F0 Reverse controls the yellow function lead. Digitrax ships all decoders set up for automatically reversing head/tail lights using F0 Fwd and F0 Rev. These can be programmed to operate separately and be controlled by the operator if you do not want automatic operation.

F1: F1 is usually used to operate the bell if sound is being used.

F2: F2 is a special key set up to act as a momentary function key. When you

press F2 the function will remain active for as long as you hold the key down. This momentary feature is important if you are using a whistle or horn. F2 can also be latched on if you are not using it for a horn.

F3-F28: these are regular on/off function keys. F3 and F4 can be turned on and off by pressing them after the FN F0 Key is pressed and you are in function mode. F7 and F8 can be accessed by pressing and holding the FN F0 Key (use this key as a “shift” key) and then pressing the F3/F7 or F4/F8 Key.

Fast clock: used by many operators during operating sessions to simulate prototypical operations. Traditionally, the fast clock is on the wall and is set up to run at a faster than normal time so that you can “get in a full day’s work on the railroad in a fraction of the time.”

Functions, Decoder: function leads are extra decoder wires that you can connect to any device on the loco that you want to control from the hand held or other input device such as a computer. These can be used for locomotive lighting, sound units, smoke units, and other locomotive animation tasks.

FX Functions: specially designed functions (available on Digitrax FX and FX³ series decoders) that let you set up lights on your loco to simulate Mars lights, Gyra lights, ditch lights, rotating beacons, single or double pulse strobes, flashing lights, random firebox flicker and more. CVs 49-63 are used to set up these special light effects.

Idle (Loco Status): a locomotive that has been addressed by the system previously, is currently selectable by a throttle on LocoNet, and is not being refreshed.

In-Use (Loco Status): a locomotive that is currently selected on a throttle connected to LocoNet. An in-use loco is having its data refreshed by the command station and is not selectable by other throttles on LocoNet. The exception to this is if a throttle “steals” an in-use loco

L: Left throttle, Left reverse key, Left side of DT402 display

Loadable Speed Table: use CV65 through CV95 to enter a value for each discrete speed step in a 28 speed step curve. This feature allows you to customize a loco’s performance curve and makes speed matching of locomotives possible. With this feature you can limit the top speed of a loco. Once you have programmed CV65 through CV95 to set up the table, you will also need to set up CV29 to enable it. This allows you to enable and disable the table at will and to keep the table stored even when it is not in use. Digitrax FX and 4th generation decoders go one step further and give you 128 speed step resolution with loadable speed tables.

LocoNet: Digitrax's powerful communications network especially designed for model railroad operation.

LocoNet ID:

Mid-Point Voltage: the value programmed into CV06 specifies the voltage to apply to the motor at speed step 15 in a 28/128 step system and step 7 in a 14 speed step system. This allows you to make a quick adjustment to the motor voltage/speed curve without setting up a loadable speed table.

MU: Multiple unit operations. See Consisting.

N: No, use the **N** / - key to respond to DT400/DT402 series throttle text messages.

New (Loco Status): a locomotive that has not been addressed by the system. A new loco is selectable by throttles on LocoNet and is not refreshed.

Operating Mode: 14 or 28/128 speed steps. See also, Speed Steps, Standard Mode, Advanced Mode and 128 Speed Step Mode.

Operations (OPS) Mode Programming: lets you program CVs in DCC locos equipped with EPF decoders while they are on the mainline. A typical use for ops mode programming would be to change the acceleration rate (CV03) or the deceleration rate (CV04) of your locos to simulate the weight and braking characteristics of the train to compensate for changing the number of cars and power units in the train.

Paged Programming: Digitrax preferred method of service mode programming.

Physical Register Programming: A primitive type of service mode programming. This method is limited to programming 2 digit address, acceleration, deceleration and start voltage.

Power Booster: See Booster

Power District and Power Sub-district: A power district is the power wiring, components and equipment attached to that wiring, driven by a single properly isolated booster. A power sub-district is a sub-division of a power district.

Power Station: See Booster

Power Supply: a transformer that provides power to the layout control system.

Programming: entering values into configuration variables (CVs) available in DCC decoders or option settings for the throttle or command stations.

Programming Track:

Purging: the process by which Digitrax command stations automatically release locomotives from “in-use” to “common” when they are not selected on a throttle connected to LocoNet. This makes locos that have been “forgotten” by their operators available to be selected by other operators to prevent problems during an operating session.

PWM: Pulse Width Modulation.

R: Right throttle, Right reverse key, Right side of DT402 display.

Recall stack: Digitrax

Release:

Refreshed (Data): Digitrax command stations re-send data to decoders many times to be sure that the signal is not lost and that you have reliable operation. All in-use and common locos in the system will continue to be refreshed until they become idle.

Route: a group of turnouts and their specified positions that will be triggered by the activation of a single “TOP” switch address to a specified position.

Scaleable Speed Stabilization (back EMF): a decoder that uses back EMF to maintain constant speed but can also buffer the speed changes to allow for optimal operation. A speed stabilized decoder that is not scaleable will cause a locomotive to maintain the speed you set no matter what grade the loco encounters. It’s like “cruise control for your loco.” If speed stabilization is not scaleable, you can have the pushy pusher problem if you run consists.

Select: To assign a decoder address to a throttle in the system so that the address can be controlled by that throttle.

Selectable: a DCC decoder is selectable when it is not currently in-use on another throttle.

Service Mode Programming: service mode programming information sent by the command station or programmer as a broadcast signal that goes out to all decoders on the track.

Slot Following: when more than one DT throttle has a single loco address selected, both DT throttles will have control of that address and both throttle displays will be updated with the same information. In other words, both operators will see what the other is doing.

Speed Steps: because DCC is a digital system, locomotive speeds are defined as discrete speed steps. This means that as motor voltage is increased, the speed of the locomotive increases in a straight line from stop to full speed with discrete speed values at each voltage.

Split field Motor: Another term for AC motor

Standard Mode (14 Speed Step Mode): the motor voltage/speed curve of the DCC loco from stop to full speed has 14 discrete speed steps. This means that speed control will be limited to just 14 steps. 14 speed step mode gives reasonably good speed control. Increasing to 28 speed step operation will give much better speed control and going to 128 speed step operation will give really excellent speed control. Standard mode is offered in many command stations because there are some decoders on the market that are not capable of 28 or 128 step mode.

Start Voltage (V-start): the voltage added to the motor drive voltage at the first speed step. This adjustment allows you to trim the loco to compensate for its motor efficiency.

Status Editing Decoders: a DCC decoder's status can be manually changed by a Digitrax command station at any time the decoder is selectable.

Stealing a Loco: overriding the in-use interlock and forcing the throttle to select an in-use loco. This can result in having two throttles logged on to and controlling one address. See also Slot Following.

t: thrown indicates that the turnout is set for the diverging route. For op switch set ups, consult your manual for the meaning of c and t.

Throttles: Throttles are input devices that tell the Command Station what you want the decoders to do. You can have many throttles on your system. The number is determined by the capabilities of the Command Station you are using. You can also use a computer to create "soft" throttles. Sometimes throttles are also called "Cabs."

TOP Locomotive: Digitrax calls the locomotive that other locomotives are consisted to, the TOP locomotive because it is not necessarily the lead loco in the consist. The TOP locomotive address controls the speed and direction of all locomotives consisted to it.

Transponding: The use of transponders installed in rolling stock and transponder detectors installed in the layout to allow the system to determine the location of a particular piece of rolling stock on the layout. Other information about the rolling stock such as speed, direction, etc. can also be determined. Transponding is useful for automation of staging yards, dispatching and for realistic sound systems.

Universal Consisting: the command station handles all consist information and lets you consist locos with any DCC decoder as well as analog locos. The locos can be added to and deleted from the consist in any orientation head to head or tail to tail.

Y: Yes use the **Y / +** key to answer questions in the DT402 text message display.

Zero-Stretching: incorporates a time period between packets to give you an effective DC offset between the two rails. This allows you to control a DC locomotive along with the DCC locomotives on a DCC system.

FCC Information

Radio or TV Interference: (this information is MANDATED by the FCC) This equipment has been tested and found to comply with the limits for a Class B digital device, pursuant to part 15 of the FCC rules. These limits are designed to provide reasonable protection against harmful interference in a residential environment. This equipment generates, uses and can radiate radio frequency energy and, if not installed and used in accordance with the instruction manual, may cause harmful interference to radio communications. However, there is no guarantee that interference will not occur in a particular installation. If this equipment does cause harmful interference to radio or television reception, which can be determined by turning the equipment off and on, the user is encouraged to try to correct the interference by one or more of the following measure

- Reorient or relocate the receiving antenna.
- Increase the separation between the equipment and the receiver.
- Connect the equipment into an outlet on a circuit different from that to which the receiver is connected.
- Consult the dealer or an experienced radio/TV technician for help.

Note that any modifications to the equipment not expressly approved by Digitrax voids the user's authority to operate under and be in compliance with CFR 47 rules, as administered by the Federal Communication Commission. Digitrax believes any conscientiously installed equipment following guidelines in this manual would be unlikely to experience RFI problems.

The DT402R is certified for "unlicensed" operations within the United States by the US FCC and has the identifier as displayed on the unit case. Canadian ID for DT402R is displayed on the unit case. See unit case for certification identifiers from other countries.

Important Note: The DT402R is certified by the FCC and by Industry Canada using a 12" LocoNet cable only. Any modification to the cable may void the certification. For convenience an extension cord may be attached with a 6 pin adapter for tethered use only.

For Canadian Users:

"This digital apparatus does not exceed the Class B limits for Radio noise emission from digital apparatus set out in the Radio Interference Regulation or the Canadian Department of Communications."

Le present appariel numerique n emet pas de bruits radio-electriques depassant les limites applicables aux appareils numeriques de la classe B prescrites dans le Reglement sur le brouillage radioelectrique edicte par le ministere des Communications du Canada.

FCC Information for RF24 module

FCC ID LV3RF24

IC 3015A-RF24

Warranty and Repair Information



Digitrax gives a one-year “no worries” warranty against manufacturing defects and accidental customer damage on all Digitrax products. That’s it! Simple, straightforward warranty, no tricky language!

All warranties on Digitrax products are limited to repair or replacement of Digitrax products at the discretion of Digitrax. Except to the extent expressly stated, there are no warranties, express or implied, including but not limited to any warranties of merchantability or fitness for a particular purpose.

For items that are no longer covered under warranty, whenever possible we will make repairs to units at fair and reasonable rates.

Please visit our warranty and repair page at www.digitrax.com/warranty for warranty and repair information and procedures.

Digitrax, Inc. reserves the right to make changes in design and specifications, and/or to make additions or improvements in its products without imposing any obligations upon itself to install these changes, additions or improvements on products previously manufactured.

Digitrax, Inc. is not responsible for unintentional errors or omissions in this document.

INDEX

2-digit address 53, 94, 98, 104
4-digit address 53, 93, 94, 98, 104

A

acceleration 96, 103, 104
address 00 16
analog locomotive 8, 16, 27
AR1 33
automatic reversing 22, 32, 33

B

BACK Key 87, 97
ballistic tracking 49, 71
Bar Graph 53, 82
battery DCS100 40, 43
Battery Installation-DT402 11
Battery Replacement-DCS100 41
battery-DT402 49, 70, 72, 76, 89
beeps 15, 38, 40, 41
Bell / 1 key 58
blinking smoke 14, 18, 50, 54, 97
Busy or Fail Message 97

C

change a LocoNet ID 74
Clean Track 102
CLOC / c 43, 44, 71, 82, 83, 87
closed 82, 106
Common 106
Common (Loco Status) 106, 111
Common Rail Wiring 27, 28, 106
CONFIG 31
Configuration Variables (CVs) 28, 92, 107, 110
Consist 71, 79, 81
Control Panel - DCS100/200 35
Control Panel - DT402 49
Coupler / 3 key 58

D

DB150 Booster 30
DCC address 104
DCS100 Audible Sounds 40
Deceleration 107, 110

Decoder Address 27, 28, 53, 111
Decoder Status 52, 100, 108
Decoder Won't Respond 103
Direct Home Wiring 28, 106, 108
Direct mode 93, 95, 98
Direction 8, 14, 16, 18, 49, 79, 107, 112
Direction Indicator 14, 16, 18, 50, 79
DISP key 98
Dispatch 19, 80, 108
Display - DT402116 14, 50
DT402 SeriesThrottle Controls At A Glance 14
double click 16
DT402 13, 14
Duplex Radio 9, 10, 70, 76, 91
duplex radio transceiver 25

E

event driven network 21

F

Fast clock 76, 83, 109
FCC Information 114
feeder wires 29
FIND Key 88
Function 14, 54, 108, 109
Function Mode 14

G

Glossary 104
GROUND 29, 31

H

Horn / 2 key 58

I

Infrared 70, 72

K

Keypad and Knob Clicks 90

L

LAMP / 0 key 58
Layout Wiring 34, 103
LCD 50
Liquid Crystal Display 50
local area network 21
Loco Icon 50
LocoNet 1, 21, 110
LocoNet Cables 24
LocoNet Connection Jacks 25
LocoNet ID 74, 110
LocoNet Wiring 24

M

mechanical detent (DT402) 49
mechanical problems 34
Mode Indicator 51
MU 110
multiple unit 107, 110

N

Nested Consisting 81
Network Speed 22
No tetherless release allowed 70
non-Digitrax decoder 94, 100, 101, 105
Numeric Keypad 58

O

OFF LINE Indicator 38
Operations Mode 27, 70, 93, 95, 96, 97, 98
Ops mode programming 27, 93, 95, 96, 110
OPT / t key 89
option settings 34, 43, 70, 89, 110
Option Switch 43, 82
Option Switch Tables 44

P

Paged 93, 94, 98, 110
Peer to Peer 21
Physical Register 93, 98, 110
PM42 33
polled buses 21

power districts 27, 29, 30, 33, 38, 110

POWER IN 8

Power Sub-district 110

PROG A 28

PROG B 28

Programming 92, 93, 95, 110

Programming CVs Other Than Addresses 95

Programming Mobile Decoder Addresses 93

Programming Track 27, 28, 92, 93, 95, 98, 111

Purging 45, 99, 111

Q

Quarter Trick 102, 103

R

Reading Back CV Values 98

recall stack 49, 91, 111

release 70, 80, 99, 111

Resuming your session 19

Reverse Key

reversing section 28, 31, 105

Route 85, 86, 111

RUN 19

Safety Selection 70

SEL Message 17

Select Address 16, 17

Semaphores 54

S

service mode programming 28, 71, 108, 110, 111

short circuit alarm 15

Shut Down 19

Slot Following 111

slot=max 99, 102

Smoke Icon 50

speed control 14, 104, 105, 112

Status Edit 100, 112

Stealing 112

Stop the Fast Clock 84

straight line tracking 49

Strange” Locomotive Lights 103
Sw (Switch) mode 43, 82, 85
switch decoder address 82
System Architecture 21

T

t 43, 112
Testing LocoNet Cables 24
tetherless release 70
Tetherless release allowed 70
Text Area 52
Throttle 14, 49
throttle ID 91
Throttle Jacks 25
Throttle Knobs 49
thrown 82, 112
Track power 15
track power indicator 15, 54
TRACK STATUS Indicator 15, 37
Track Wiring 29
Transformer 110
Transponding 88, 113
Troubleshooting 34, 38, 101

U

UP5 Universal Panel 25, 26
UR90 Infrared Receiver 26, 70, 72,
74
UR91 Radio Receiver 25, 26, 70,
72, 74, 75
UR92 Duplex Radio Receiver 9,
25, 26, 70, 72, 99

W

Warranty and Repair 115
wire sizes 29