



**Premium Advanced Digitrax Complete
Train Control Starter Set Manual**

Includes Instructions for:
DCS210 Command Station Booster
DT500 Series Throttle
Duplex Radio Operation with UR92 & DT500D
Infrared Operation with UR90 & DT500
Walkaround Operation with UP5



Digitrax, Inc.
2443 Transmitter Road
Panama City, Florida USA 32404
Support: helpdesk.digitrax.com
www.digitrax.com

Digitrax Manuals & Instructions are updated periodically.
Please visit www.digitrax.com for the latest version of all
manuals & for available firmware updates.

Introduction

Congratulations on your purchase of a Digitrax Evolution Advanced Digitrax Complete Train Control Starter Set!

The design of the Digitrax Complete Train Control® system lets you operate your layout the way you choose. With LocoNet® you simply connect system components to build the layout control system that you've always wanted! The Digitrax system reduces and simplifies layout wiring.

Your Super Evolution Starter Set has several components:

- **DCS210** is your system's advanced command station. It generates the information packets that tell the decoders what to do.
- **DCS210** is also a booster. Boosters receive signals from the command station, amplify them and put them on the track along with the power from the power supply to run the locomotives. You can have several boosters on your layout to provide additional power to run more locos.
- The **DT500** or the **DT500D** is the throttle that comes with your Evolution Starter Set. Throttles are the handhelds you use to tell the command station what you want the decoders to do. You will probably have several throttles on your layout if you have more than one person running trains at a time.
- A **UP5** Universal Panel for memory walkaround operation or a **UR92** Duplex Radio Transceiver for duplex radio or IR operation.
- A **PS615** 15 volt, 6 amp DC power supply to provide the power to your DCS210 and layout.
- **LT1** LocoNet and Decoder Tester.
- A 2' LocoNet Cable so you can get started right away.

In addition to your Evolution Starter Set you'll need:

- One or more mobile decoders for your locomotives.

This manual contains information about running your layout with DT500 tethered, infrared and/or DT500D Duplex Radio operation.

There are many different combinations of Digitrax components that can be used to set up a layout control system that is right for you. You can combine Digitrax products with compatible decoders, boosters and computer software made by other companies that build compatible equipment.

Your success with & enjoyment of our products are very important to us. After all, this is a hobby and it is FUN!!! Please read this manual carefully before installing your system. We have included lots of hints and operating ideas based on our experience. If you have questions not covered by this manual please contact your dealer or visit our web site at www.digitrax.com where the Digitrax online Tech Support Depot is always open!

1.0	DCS210 Quick Start Guide	8
1.1	Connect the DCS210 to the power supply	9
1.2	Connect Your Throttle to the DCS210	9
2.0	Evolution Duplex Radio Quick Start Guide	10
2.1	UR92 Installation/Quick Start.....	10
2.2	Join Your DT500D Throttle to the Duplex Group.....	10
3.0	DT500 Battery Installation.....	12
4.0	Additional Quick Start Basics.....	13
4.1	DT500 Powering ON and OFF	13
4.2	DT500 Series Throttle Keyboard Layout.....	15
4.3	DT500 Series Throttle Controls At A Glance.....	16
4.4	Turn track power on and off	17
4.5	Select and Run An Analog Loco on Address “00”.....	17
4.6	Select and Run A Decoder Equipped Loco	18
4.7	Shutting Down the System	20
4.8	Resuming your session.....	21
4.9	Quick Start Problems?	21
4.10	What’s Next?	22
5.0	LocoNet: The Digitrax Difference!.....	23
5.1	System Architecture	23
5.2	Event Driven or Polled?	23
5.3	Network Speed	24
5.4	LocoNet Personal Edition	24
5.5	LocoNet Expansion for Complete Train Control	24
5.6	LocoNet Wiring Components.....	26
5.7	Making LocoNet Cables.....	26
5.8	Testing LocoNet Cables with an LT1	27
5.9	LocoNet Throttle & Connection Jacks.....	27
5.10	Installing the Universal Panel (UP5).....	27
5.10.1	Hooking up the UP/UR’s Track Status Indicators	28
6.0	Advanced Installation On Your Layout.....	29
6.1	Setting Up A Programming Track	29
6.1.1	Ops mode programming	29
6.1.2	Service mode programming	30
6.2	Direct Home Wiring vs. Common Rail Wiring	30
6.3	Recommended wire sizes	31
6.4	Other Track Wiring Considerations	31
6.5	Layout Power Districts	31
6.5.1	Number of Locos.....	32
6.5.2	Short Circuits.....	32
6.5.3	To set up power districts & sub-districts:.....	32
6.5.4	Do I have enough power to run my trains?.....	32
6.6	Adding a Booster	32
6.7	Reversing Section Wiring	33
6.8	Power Managers for Sub-Districts & AutoReversing.....	33

- 6.9 Using AR1 for AutoReversing33**
- 6.10 Troubleshooting Layout Wiring.....33**
- 7.0 DCS210 Control Panel35**
- 7.1 Power (PWR) Indicator35**
- 7.2 Power In Barrel Plug (5A) or Terminals (“+” and “-“ 8A)....35**
- 7.3 Program A and B terminals (PA and PB)36**
 - 7.3.1 Program A and B terminals as a Braking Section.....36**
- 7.4 Program (PROG) Indicator36**
- 7.5 Ground (GR) Terminal36**
- 7.6 Rail B (RB) and Rail A (RA) Terminals.....36**
- 7.9 TRACK STATUS Indicator37**
- 7.10 LOCONET Jacks A, B and C37**
- 7.11 SCALE Switch (O/G, N, HO)37**
 - 7.11.1 DCS210 Voltage Trim Settings.....37**
 - 7.11.2 Heat Dissipation39**
 - 7.11.3 Troubleshooting DCS210 Shutdowns39**
 - 7.11.4 DCS210 Safe Operation Mode.....39**
- 7.12 MODE Switch40**
- 7.13 NET Indicator40**
- 7.14 LOCO RESET Button40**
- 7.15 Easy Routes (EZ RTS) button40**
- 7.16 DCS210 Audible Sounds41**
- 7.17 DCS210 Indication Lights.....42**
- 8.0 Customizing DCS210-Option Switch Setup43**
- 8.1 Changing DCS210 Option Switches.....43**
- 8.2 DCS210 Option Switch Tables45**
- 9.0 DT500 Series Throttle Control Panel.....51**
- 9.1 General Information51**
- 9.2 L (Left) and R (Right) Throttle Knobs51**
- 9.3 Liquid Crystal Display (LCD)52**
 - 9.3.1 Loco Icon52**
 - 9.3.2 Direction Indicators52**
 - 9.3.3 Smoke Icon52**
 - 9.3.4 Mode Indicator.....53**
 - 9.3.5 Text Area53**
 - 9.3.6 L (Left) and R (Right) Throttle Display53**
 - 9.3.7 L and R Bar Graph54**
 - 9.3.8 Function Display56**
 - 9.3.9 Track Power Indicator.....56**
 - 9.3.10 Tetherless Indicator56**
 - 9.3.11 L and R Semaphores-Cab Signaling56**
- 9.4 DT500 Keypad57**
 - 9.4.1 FUNC Key.....57**
 - 9.4.2 MU Key57**
 - 9.4.3 LOCO Key57**

9.4.4	SWCH Key	57
9.4.5	L and R Reverse Keys	57
9.4.6	Y / + and N / - Keys	57
9.4.7	DISP Key	58
9.4.8	PROG Key	58
9.4.9	EDIT Key	58
9.4.10	FIND Key	58
9.4.11	BACK Key	58
9.4.12	PWR Key	59
9.4.13	OPTN / t Key	59
9.4.14	CLOC / c Key	59
9.4.15	EXIT Key	60
9.4.16	ENTER Key	60
9.4.17	EMRG STOP Key	60
9.5	Full Numeric Keypad	60
9.6	Infrared Emitters	61
10.0	How to Select and Run Trains	62
10.1	DT500 Powering ON and OFF	62
10.2	Turn track power on and off	63
10.3	Select and Run An Analog Loco on Address "00"	64
10.4	Select and Run A Decoder Equipped Loco	65
10.5	Locomotive Speed Control	67
10.6	Releasing An Address From A Throttle	67
10.7	Dispatching addresses or consists	68
10.8	Recall a Loco	68
10.9	Stealing: Forcing An Address Selection	69
10.9.1	StealZap	70
10.9.2	Slot Following	70
10.10	"slot=max" Message	71
10.11	SlotZero	71
11.0	Stop	72
11.1	Setting A Loco to Zero Speed	72
11.2	Emergency Stop	72
11.2.1	Local Stop-Factory Default	72
11.2.2	Track Power Off Stop	72
12.0	Controlling Functions	73
12.1	Controlling Functions F0-F12	73
12.1.1	Function 0 (F0)	73
12.1.2	Function 2 (F2)	73
12.1.3	Functions 1, 3, 4, 5, 6, 7, 8, 9, 10, 11, & 12	74
12.2	Controlling Expanded Functions F13-F19	74
12.3	Controlling Functions 20-28	75
12.4	Controlling Functions On Consisted Locomotives	75
13.0	Tetherless Operation	76
13.1	General Tetherless Operations	76

13.1.1	Selecting a Locomotive-Safety Selection	76
13.1.2	Releasing An Address Using IR	76
13.1.3	Multiple Unit Operations While IR Tetherless	76
13.1.4	Programming While Tetherless	76
13.1.5	Switch Mode	77
13.1.6	Ballistic Tracking.....	77
13.1.7	Fast Clock	77
13.1.8	Throttle Keypad Lock	77
13.2	Using the DT500 Throttle In IR Mode	77
13.2.1	LocoNet ID Change	79
13.2.2	Adding More UR90, UR91 and UR92s To LocoNet.....	79
13.4	Using the DT500D Throttle in Duplex Radio Mode.....	80
13.4.1	Join a Duplex Group.....	80
13.4.2	Configuring the Duplex Group name	81
13.4.3	Configuring the Duplex Group Channel (11-26).....	82
13.4.4	Configuring the Duplex Group Password (Key)	82
14.0	Advanced Operations Capabilities.....	83
14.1	Multiple Unit Operations.....	83
14.1.1	Adding a Locomotive To A Consist	83
14.1.2	Removing A Loco From A Consist.....	85
14.1.3	Nested Consisting.....	85
14.1.4	MU of Mismatched Locomotives	85
14.2	Sw (Switch) Mode	85
14.3	Fast Clock and Routes	87
14.3.1	Fast Clock Basics	87
14.3.2	Stop the Fast Clock.....	87
14.3.3	Edit Fast Clock Time, Rate and Alarm	87
14.4	Route Basics	88
14.4.1	DCS210 Routes OpSW	89
14.4.2	External Routes	89
14.4.3	Setting up Routes using the EZ RTS button	89
14.4.4	Edit Routes Using Your DT500 throttle.	90
14.5	Query Mode	92
14.5.1	DCS210 Reported Statistics.....	92
14.6	Input Mode	94
14.7	FIND Key and Digitrax Transponding	95
15.0	Customizing Your Throttle - Step-by-Step	96
15.1	Changing the Throttle Options	96
16.0	Programming Configuration Variables (CVs).....	99
16.1	Programming Mobile Decoder Addresses	100
16.2	Programming CVs Other Than Addresses	102
16.3	Operations Mode Programming	103
16.4	Busy or Fail Message	104
16.5	Reading Back CV Values Programmed	104
17.0	How the DCS210 Manages Addresses.....	106

17.1 Purging of addresses:	106
18.0 Decoder Status	107
18.1 Status Editing Decoders.....	107
18.2 Note for Non-Digitrax Decoder Users	108
19.0 Updating the DCS210 to the latest firmware	108
20.0 UR92 Additional Information	108
20.1 Advanced UR92 Installation.....	108
20.2 Troubleshooting UR92 Installation.....	110
20.3 Resetting UR92 To Factory Defaults.....	110
21.0 Troubleshooting Problems	111
21.1 I'm lost!.....	111
21.2 Runaway train or layout!	111
21.3 Nothing is responding	111
21.4 Can't select a loco on my throttle	111
21.5 Clean Track.....	111
21.6 The Quarter Trick	111
21.7 The LT1 Tester.....	112
21.8 Decoder Won't Respond	112
21.9 "Strange" Locomotive Lights	112
Glossary	113
FCC Information	123
Warranty and Repair Information	124
Index	125

1.0 DCS210 Quick Start Guide

These instructions will get you up and running in just a few minutes! A full description of all controls and technical reference information are included later in this manual. This section assumes that you are using a new set straight out of the box. If your set is duplex equipped, we recommend that you follow this quick start guide without using duplex radio to learn the basics. When you are successfully running your duplex throttle tethered to the system, then continue with the Quick Start Duplex section that follows to learn how to operate in the Duplex Radio mode

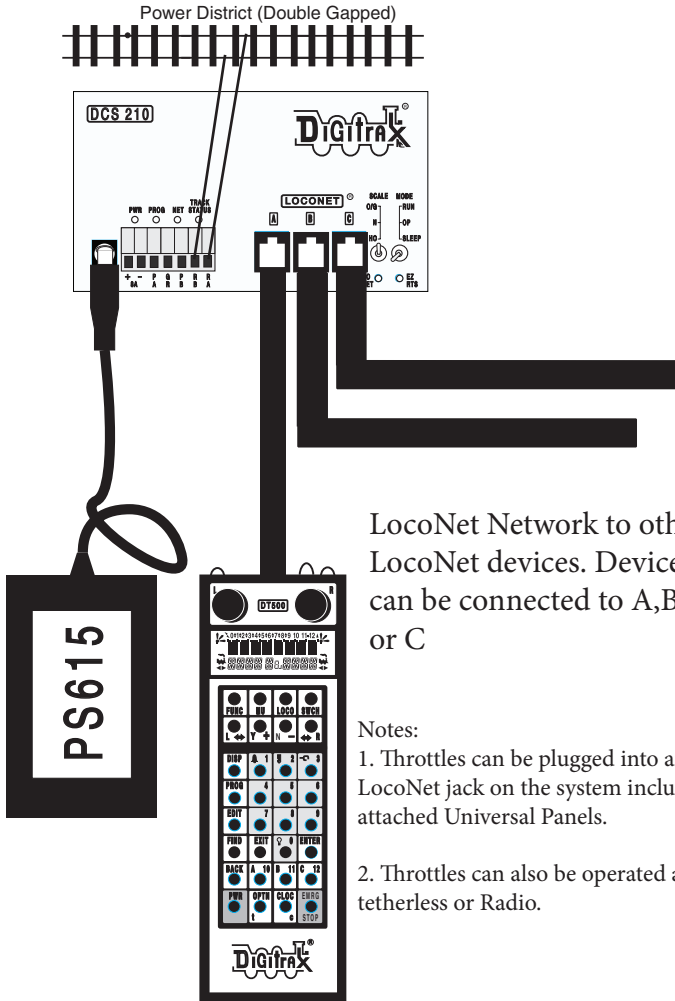

LocoNet Network to other LocoNet devices. Devices can be connected to A,B, or C

Notes:

1. Throttles can be plugged into any LocoNet jack on the system including attached Universal Panels.
2. Throttles can also be operated as IR tetherless or Radio.

DCS210 Quick Start Hook Up

1.1 Connect the DCS210 to the power supply

1. Set the DCS210's SCALE switch to the scale you are running: N, HO, O/G. Use the lowest setting that will run your layout.
2. Set the MODE switch on the DCS210 to the RUN position.
3. Plug the PS615 power supply into the DCS210 using either the barrel plug connector
4. Plug in the PS615 power supply to power up your DCS210.
5. DCS210 will beep twice and its PWR indicator will light GREEN winking off every 3 seconds as a "Heartbeat".

1.2 Connect Your Throttle to the DCS210

1. Plug the DT500 series throttle into the LocoNet "A" jack on your Digitrax Command Station.
2. Press the **PWR** key then the **N / -** key on your throttle. The TRACK STATUS LED on the command station should be off.
3. Press the **Y / +** key on your throttle. The TRACK STATUS LED should come on green.
4. Turn the **R** Throttle Knob of the throttle about 1/4 turn. You should see the right side "SEL" in the display begin to blink.
5. Press the **LOCO** key, then the **LAMP/0** key, then the **LOCO** key. You should see "00" replace the blinking "SEL".
6. Turn the **R** Throttle Knob clockwise to "99".
7. Press the **REVERSE / R** key and look for a change in brightness (or color) of the TRACK STATUS LED on the command station. Turn **R** Throttle Knob counterclockwise to "00".
8. Connect the RAIL A and RAIL B terminals from your Command Station to your test track and place an analog locomotive (without a decoder) on the track. The loco should "sing". Use the **R** Throttle Knob to control speed and the **REVERSE / R** key to control direction.
9. Place a locomotive with a decoder with a known address on the track. Turn the **L** Throttle Knob. You should see the left side "SEL" in the display begin to blink. Press the **LOCO** key, then the numbers for the address, then the **LOCO** key. The loco address will replace the blinking "SEL".
10. Use the **L** Throttle Knob to control speed and the **L / REVERSE** key to control direction of the decoder equipped loco and the **R** Throttle knob and the **REVERSE / R** key to control the analog locomotive.

Enjoy running your trains!

2.0 Evolution Duplex Radio Quick Start Guide

2.1 UR92 Installation/Quick Start

The UR92 Duplex Radio transceiver/IR receiver is simple to install and begin using on your layout.

1. In most cases the UR92 should be situated near the physical center of your layout. One UR92 usually covers a circle of about 150+ feet across. Some layouts may require additional UR92s for adequate signal coverage.
2. Connect the PS14 DC power supply to the UR92 via the DC power jack on the side of the UR92. Plug the PS14 into a 110 V outlet. The green and red LEDs should blink and the red LED should stay on.
3. Connect the UR92 to your working LocoNet using one of the RJ12 jacks at the rear of the UR92. The red LED will go off and the GREEN **RADIO** LED will wink at a 2-second interval to indicate that it is configured for duplex radio operation.
4. If your layout has UR91s and or UR90s installed, re-set the LocoNet ID by plugging in any DT500 throttle while holding down the **EDIT** Key. Release the **EDIT** Key. Use the R throttle knob to set the LocoNet ID (00-07) you want to use and press the **ENTER** key to complete LocoNet ID set up. As simplex and infrared throttles plug in to LocoNet, they will log on to the LocoNet ID automatically and all three technologies will work together.

That is all that is required for UR92 installation! You are now ready to join the Duplex Group with your DT500 Duplex Throttle! See UR92 installation guide for additional information on setup and troubleshooting.

2.2 Join Your DT500D Throttle to the Duplex Group

The following plug in method of joining the UR92 Duplex Group is convenient and will always work to join any Duplex throttle to a particular UR92 Group. See Section 13.4 for instructions on tetherless operation of the DT500D, including how to join a Duplex Group without plugging in to LocoNet.

1. Install a known good 9v battery in your DT500D Duplex Radio Throttle. Connect the DT500D Duplex Radio Throttle to the front RJ12 jack of the UR92 and wait until the throttle re-initializes.
2. Disconnect the DT500D from the LocoNet jack. The DT500D will briefly display battery power then, an 8 character Duplex Group name and the Channel number (#11 through #26) being used by the Group. The Duplex Group name is not important at this point, it is simply used by the DT500D to join this Duplex group on its particular Duplex channel. Note: If your DT500 throttle displays "Idle" at this point, simply plug in to LocoNet again and allow your throttle to re-initialize.
3. The DT500D has now joined the Duplex Group and can be operated as if it were plugged in to LocoNet.

4. Use the DT500D throttle to select one of the locomotives on your system. The UR92's GREEN **RADIO** LED will blink to show that good duplex messages are being received. If the RF transmissions are not acknowledged by the UR92, the DT500D will blink its white "flashlight" LED to show that there is a duplex radio communication problem. This usually indicates a range or interference issue. (See the UR92 manual for more information on troubleshooting duplex radio issues.)
5. DT500Ds remember the last Duplex Group they joined, even if the unit is turned off or the batteries are removed. When re-powered they will automatically rejoin this particular Group if it is within duplex radio range without being plugged in to the system.

You are now ready to run your trains in Duplex Radio mode!

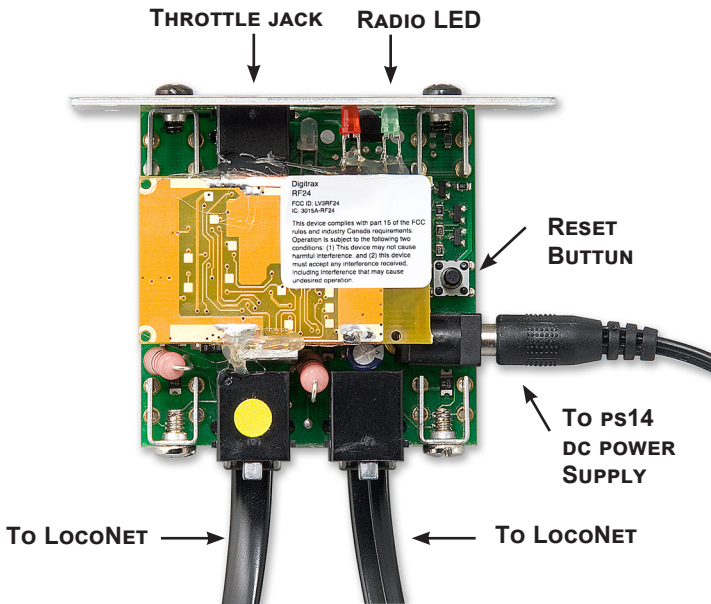

3.0 DT500 Battery Installation

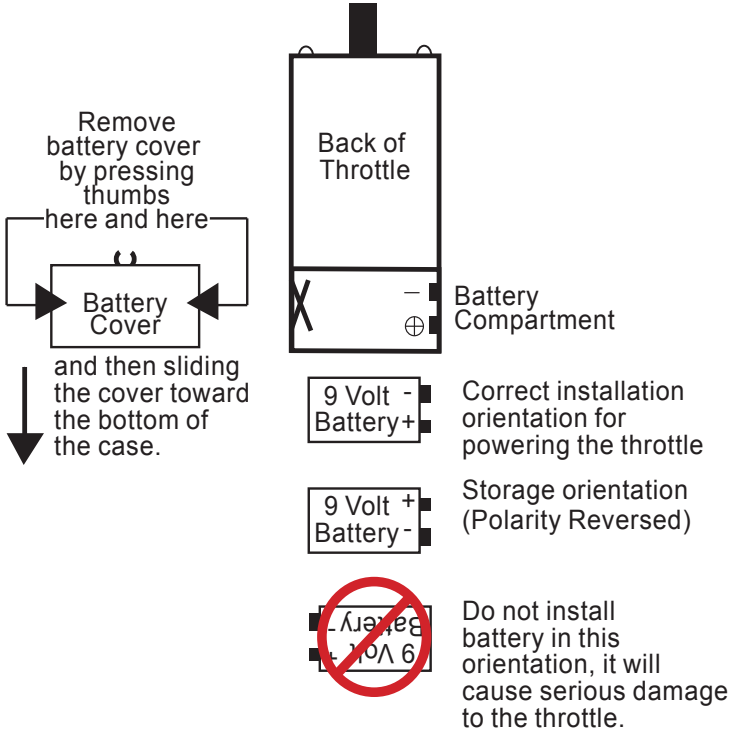

It is recommended that a battery be used in you DT500, especially if you operate your DT500 as a walkaround throttle. The unit will function when plugged in without a battery, however the display will go off when you're not plugged in to LocoNet. Therefore, for the best operating experience the DT500 should always be operated using a battery.

Your DT500D must have a 9-volt battery installed for proper tetherless operations. When you install the battery press and hold the **PWR** key to turn your throttle on, the throttle will report the battery voltage then display the last screen displayed before the throttle was powered off.

When unplugged from LocoNet your throttle can be turned off to conserve battery life.

DT500 throttles are shipped with the maximum power save options enabled. To make your batteries last even longer, you may choose to turn off the display backlight. Your throttle can also be set to power OFF after being in Power Save mode for 20 Minutes. See Section 15.0 for throttle customization options.

4.0 Additional Quick Start Basics

4.1 DT500 Powering ON and OFF

DT500 throttles have the capability of being powered OFF and ON in order to save battery power while unplugged without having to remove the battery. A throttle will automatically power ON when it is plugged into an active LocoNet. While plugged into a powered LocoNet the DT500 cannot be powered OFF.

To power on your throttle:

1. After Installing a known good battery into your throttle Press and hold the **PWR** key until the display comes on.

2. The DT500 will briefly see the DT500 splash screen:

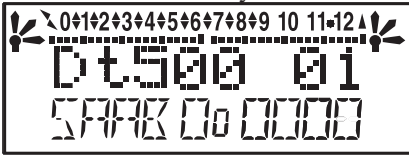

This screen shows the throttle type: DT500 or DT500D and software version number (xx). It is displayed for a few seconds each time you power your DT500.

3. The DT500D will then momentarily display the Duplex Group name and radio Channel.
4. Next you will see the power indicator screen.

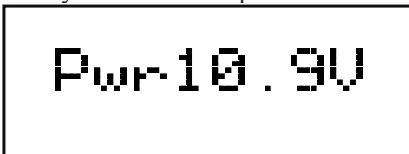

This screen indicates the power available to the throttle. When you are plugged in to LocoNet, this value should be between 9 and 15 volts for proper operation. When you insert a battery or unplug from LocoNet, the value displayed will be the battery power available. When this number is less than 6.2 volts it's time replace your battery. See Section 3.0 for more information about installing/replacing the batteries in your DT500.

5. If you are using a DT500 throttle, the throttle will now go Idle until it is plugged into an active LocoNet. A DT500D throttle will attempt to log onto the last network it was joined to. If it cannot find the network, it will go idle. It will need to be plugged into an active LocoNet or manually joined to a network as outlined in section 13.4.1.

6. Once you are connected to an active LocoNet you will see a screen similar to the following.

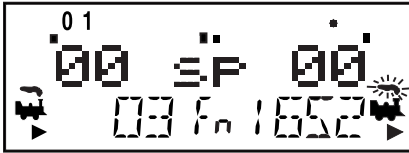

This screen displays current addresses selected on the L and R throttles along with their current speed and direction. The functions that are turned ON for the active throttle (the one with the blinking smoke icon) are displayed across the top of the display.

To power off your throttle:

If your throttle is unplugged and in an Idle state:

1. Press and hold the **PWR** key until the screen displays “Pwr Off”
2. The screen will then briefly display the power indicator screen, then power off completely.

If your throttle is unplugged and operating in IR/Duplex Radio Mode:

1. If the throttle is in power save mode wake the throttle by pressing and holding the **EXIT** key until the throttle screen displays
2. Press the **PWR** Key then press the **BACK** key.
3. The screen will display “Pwr Off”, then briefly display the power indicator screen, before powering off completely.

4.2 DT500 Series Throttle Keyboard Layout

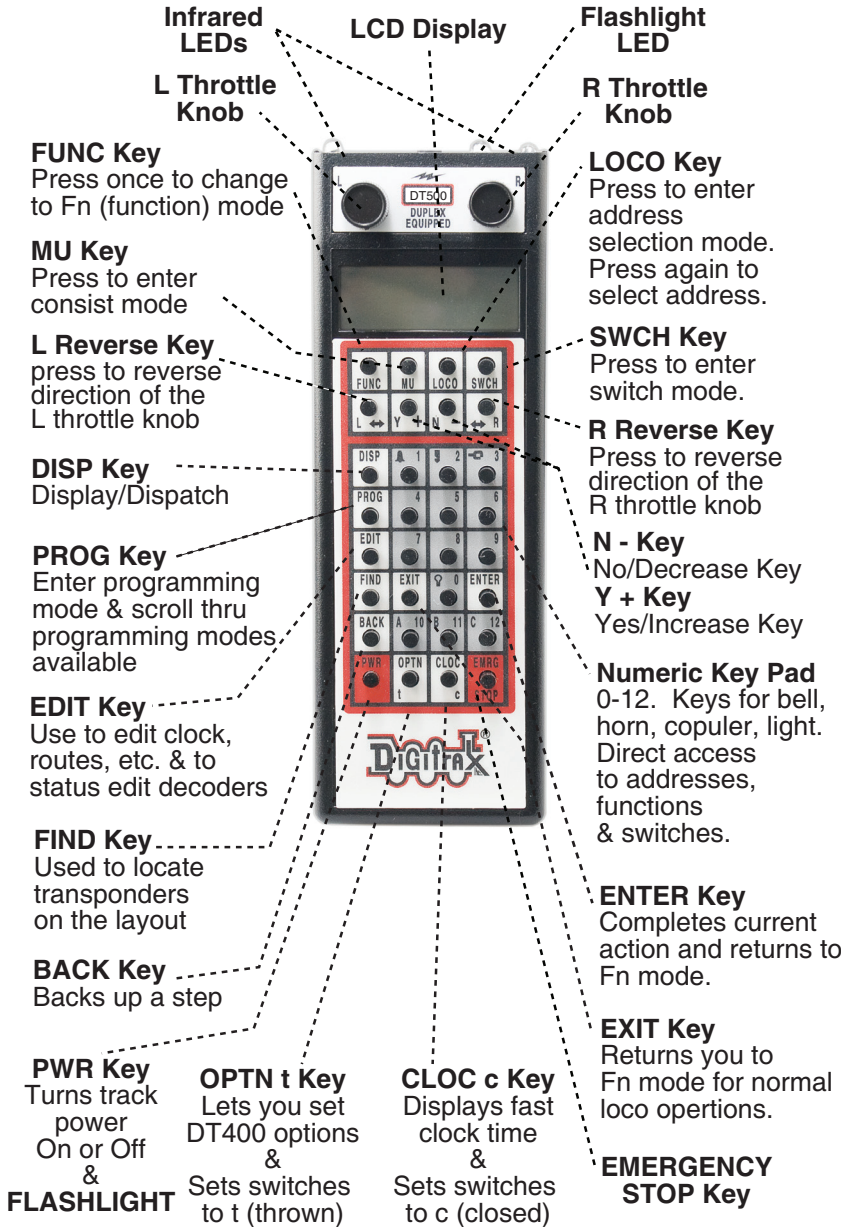

Remember, the EXIT Key will take you back to the Fn Mode for Normal Loco Operations.

4.3 DT500 Series Throttle Controls At A Glance

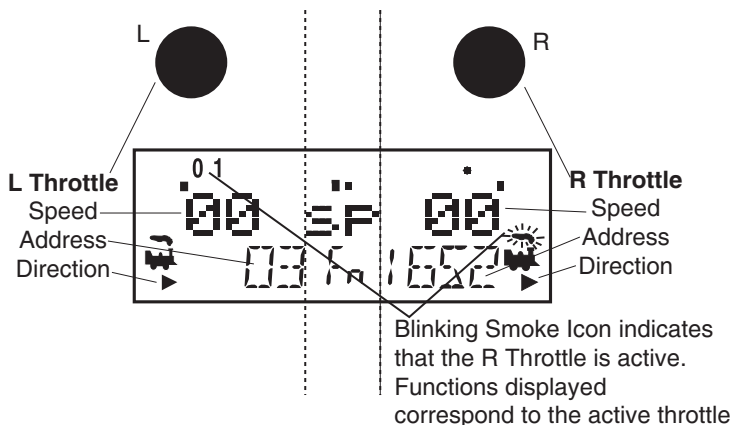

1. The DT500 handheld has two knobs called the **L** Throttle (Left) and the **R** Throttle (Right). The throttles are used for speed control, direction changes, and input of information for operation of your railroad.
2. The row of numbers (0-12) across the top of the display are the functions being used by the active locomotive throttle.
3. The larger numbers in the middle of the screen indicate the speed of the locomotives being controlled by the throttles.
4. The numbers at the bottom of the display are the locomotive addresses, and correspond to the digital decoder that is in each locomotive.
5. There are two locomotives located in the lower corners of the display, one for the **L** Throttle and one for the **R** Throttle. Blinking smoke above the locomotive indicates which throttle is currently active.
6. There are Direction Indicators (arrow heads) located under each locomotive which indicate the direction of travel for each locomotive. The arrows indicate whether the locomotive is moving forward or reverse, not the direction of travel on the track.
7. The function numbers and text information displayed on the display screen is for the active throttle. Keypad entries control functions for the active throttle.
8. The current mode of operation is shown in center of the bottom line of the display. The normal operating mode is Fn or Function Mode for running trains. In this mode, the throttle knobs and direction keys control the speed and direction of the locos. The **Y / +** and **N / -** keys can also be used to increase or decrease speed. The numeric keypad is used for direct access to functions.

4.4 Turn track power on and off

The TRACK POWER indicator on your DT500 display shows the track power status. There is also a TRACK STATUS LED on your Command Station. If the TRACK POWER indicator is lit then track power is on. To turn the track power on or off:

1. Press the **PWR** key on the DT500. You will see a screen similar to the one below. You will now be able to toggle the track power on/off:

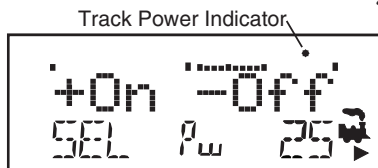

2. Press the **N / -** key to toggle the track power off. The TRACK POWER Indicator on your DT500 and on your Command Station will go off. “tOFF” will flash in the right throttle address area.
3. Press the **Y / +** key to toggle the track power on. The TRACK POWER Indicator on your DT500 display and on your Command Station will come on solid.
4. Press the **PWR** key again to return the DT500 to the operating mode.
5. If the TRACK POWER Indicator is blinking and you see “Idle” flashing in the right throttle address area then the layout is in the “IDLE” state and no locomotives will move. To exit this state simply turn on track power again. This is a common issue, and is easy to correct.

4.5 Select and Run An Analog Loco on Address “00”

1. Place an analog locomotive (one without a decoder) on your layout. While the analog loco is sitting still, you will hear the characteristic “singing” caused by the DCC track signal when it is applied to analog locomotives. Once the analog loco is moving, this sound will change and be less noticeable. (Digitrax recommends that analog locos not be left sitting on DCC powered track for long periods of time when they are not running.)
2. Check the Track Power Indicator is steady on your DT500’s display and the TRACK STATUS LED on Command Station is lit .
3. Activate the DT500’s **R** Throttle knob by turning it a 1/4 turn in either direction or by pressing the **R** Throttle knob once if there is a current loco address and double click if SEL appears in the **R** address. If there is a loco address, the **R** Loco Smoke will start flashing. If no loco has been previously selected on this throttle it will flash “SEL”.
4. Press the **LOCO** key then 00 on the keyboard. You can also use the **R** throttle knob to dial in the number. You will see a display similar to this:

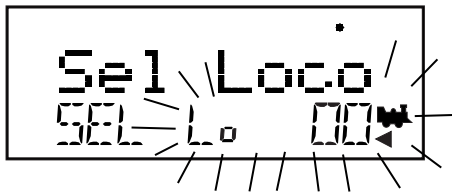

5. Press the **LOCO** key again to select address 00 on the throttle. You can also press the **R** Throttle knob once to select the loco address and return to Fn mode for normal operation.

Note: **EXIT** key can be used to return to Fn mode for normal loco operation.

6. Turn the **R** Throttle knob clockwise slowly to increase the speed of the analog locomotive. As the speed increases, the locomotive on the track will begin to move. Your command station's TRACK STATUS indicator should change color as you change the speed setting.
7. Press the **REVERSE / R** key on the right side of the DT500 or double click the **R** Throttle knob to reverse the direction of the analog loco. The **R** Direction Indicator will toggle between the left and right arrows. In the case of the analog loco, the indicator only indicates a change in track polarity and the physical direction of the analog locomotive-NOT THE ANALOG LOCO'S ACTUAL FORWARD OR REVERSE DIRECTION OF TRAVEL.

Note: To double click the throttle knob, quickly press down on the throttle knob twice within about 1/2 second. You will hear a click each time you press down on the throttle knob.

4.6 Select and Run A Decoder Equipped Loco

Each decoder has an address. To select a decoder equipped locomotive and run it on either throttle, you must know its address. Digitrax decoders are set up at the factory with the "default" address 03. This means that when you take a Digitrax decoder out of the package and install it in your loco, you can select address 03 on your throttle and run the decoder. The first Configuration Variable (CV) programmed by most users is the decoder's address since it is not very useful to have all of your locos run on address "03."

If you do not know the address of the decoder equipped locomotive you want to run, you can simply program the decoder's address and select it to run using the new, known address. With some command stations, it is possible to read back the decoder's address. *See your Digitrax Starter Set Manual for information about reading back addresses and see your Digitrax Decoder Users Manual for a complete discussion of decoder addressing.*

1. Place a decoder equipped locomotive (one with a decoder installed) on your layout.
2. Check the Track Status indicator is steady on your DT500's display and

the Command Station TRACK STATUS LED is lit, so track power is turned on.

3. Activate the DT500's **L** Throttle knob by turning it a 1/4 turn in either direction or by pressing the **L** Throttle knob once if there is a current loco address and double click if SEL appears in the **L** address. If there is a loco address, the **L** Loco Smoke will start flashing. If no loco has been previously selected on this throttle it will flash "SEL".
4. Press the **LOCO** key. The left side of the display will begin flashing. You will see a display similar to this:

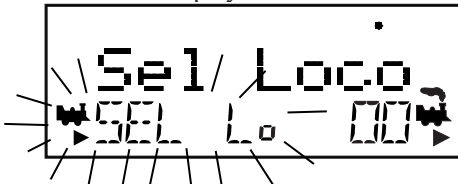

5. Use the numeric keypad to enter 03 or use the **R** Throttle knob to select Address "03" in the left side of the display. (The **R** Throttle knob changes 1s and 10s, the **L** Throttle knob changes 100s and 1000s.)

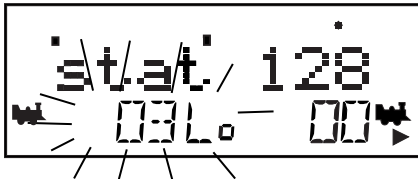

6. Press the **LOCO** key again to select address 03. Press the **L** Throttle knob once to select the loco address and return to Fn mode for normal operation.

The illustration below shows the display after address "00" is selected on the **R** Throttle and address "03" is selected on the **L** Throttle, We see the Track Power On Indicator in the top line, the speed bar graphs at 0 speed and the text area also at 0 speed for both throttles.

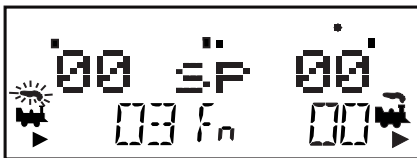

7. Turn the **L** Throttle knob clockwise slowly to increase the speed of the decoder equipped locomotive. As the value in the left display increases, the decoder equipped locomotive on the track will begin to move.
8. Press the **L / REVERSE** key on the left side of the DT500 or double click the **L** Throttle knob to reverse the direction of the decoder equipped loco. The **L** Direction Indicator will toggle between the left and right arrows. In

the case of the DCC loco, the arrow indicates locomotive direction (forward or reverse), not the direction on the track.

- Use the **R** Throttle knob and **REVERSE / R** key to control the analog loco and the **L** Throttle knob and **L / REVERSE** key to control the decoder equipped loco. You can control both at the same time.

Throttle in normal operations mode indicated by Fn.
In Function (Fn) Mode
Throttle knobs control Loco's Speed & Direction
Keypad entries control functions

Track Power Indicator ON

2 digit address 03
Selected on the L Throttle
Running at 20% speed
In reverse
Function 0, 1, & 3 on.

An analog loco address 00
Selected on the R Throttle
Running at 25% speed
The direction arrow below the Loco Icon **does not** indicate actual direction for Analog locos.

Notice as you use each throttle knob or direction key that the loco with the “blinking smoke” will change to that side of the throttle. The side with the “blinking smoke” indicator is the active throttle. To control the headlight or other functions, the locomotive must be on the active throttle.

4.7 Shutting Down the System

When you are finished with your session, shut down the DCS210 by turning off power to the system.

Some users prefer to “dispatch” or release all addresses active in their system before shutting down. This can prevent unexpected results when you power up the layout again. *The dispatch procedure is covered in detail in Section 10.7*

- Press the **PWR** key followed by the **N / -** key, the TRACK POWER Indicator on the throttle and the TRACK STATUS Indicator on your DCS210 command station will go off.
- Move the command station’s MODE switch to the SLEEP position and wait 5 seconds.
- Turn off the power supply to the system.

The power to the command station can be left on all the time if desired. In “sleep” mode, the command station consumes very little energy. In this state the command station provides keep alive power to all throttles that are connected to LocoNet.

4.8 Resuming your session

When you are ready to resume your session:

1. Turn on the power to the system.
2. Switch the DCS210's MODE switch to the "RUN" position. All attached throttles will beep within a couple of seconds to indicate that LocoNet is active again.
3. Check the TRACK STATUS indicator on the DCS210. If it is not lit then turn track power on as follows: Press the **PWR** key followed by the **Y / +** key, the TRACK POWER Indicator on the throttle and the TRACK STATUS Indicator on your command station will come on. By default the DCS210 will resume in whatever state it is powered off in.

4.9 Quick Start Problems?

If you encountered problems at any step in this Quick Start Section:

First, try backing up a step until you get results described. The steps included in this installation procedure are set up so that if you follow them carefully, any problems you encounter will be easy to isolate and correct.

If that does not work or if you have other questions or problems, we encourage you to visit the Tech Support Depot at www.digitrax.com/support. You may also submit help ticket to our tech support staff at helpdesk.digitrax.com.

There are thousands of successful Digitrax installations around the world and we want to be sure that yours is one of them.

Note for users of Digitrax decoders that have already been programmed and decoders not made by Digitrax:

1. The DCS210 command station defaults to 128 speed step operation so, if you are using a locomotive with a decoder that does not have 128 step capability you will have to adjust either the decoder or the DCS210 command station so that both are using the same number of speed steps to communicate. You can status edit each individual decoder or you can change the DCS210's system default and run all of your decoders with fewer speed steps to accommodate these decoders (*see Section 8.2 customizing OpSw 21-23*).
2. If you can't control the operation of the lights in your decoder equipped locomotive with the throttle (in default 128, or 28 speed step mode), be sure that the decoder itself is programmed in advanced 28 speed step mode. Please refer to your throttle manual for instructions on how to correctly status edit your decoder.

4.10 What's Next?

Now that you have successfully set up your Evolution Set, it's time to learn more about the features and options offered by Digitrax Complete Train Control and the LocoNet system. Read the manual and take time to understand and master each topic. Your Evolution Set is the gateway to all the possibilities and options offered by Digitrax so the best advice is to take it step by step and don't try to do everything at once. For additional resources check out the Digitrax web site at www.digitrax.com.

5.0 LocoNet: The Digitrax Difference!

5.1 System Architecture



System architecture is the biggest difference among layout control systems. System architecture is the way the components of a control system communicate among themselves. Digitrax LocoNet is a Peer to Peer local area network (LAN) designed specifically for model railroad operation. LocoNet wiring is cost effective, flexible and expandable to accommodate almost anything you want to do with your railroad today and in the future.

The system architecture used for communication within DCC and other control systems is not standardized. Therefore DCC compatibility encompasses only decoders, command stations and boosters but not throttles and other devices. In addition, devices that require feedback and other types of signals that are outside the domain of DCC, such as detection systems and transponding, are not standardized. LocoNet is a hybrid system that incorporates DCC and other technologies to expand the capabilities of your system. Your Digitrax system gives you the best of both worlds with a system that is compatible with today's DCC standards and also goes beyond those standards to deliver enhanced system performance and advanced features that are far beyond the scope of DCC. With Digitrax, you get Complete Train Control®!

5.2 Event Driven or Polled?

LocoNet is an event driven network. The command station on LocoNet waits for input from other components before sending commands to the layout. For example, if there are 10 throttles on LocoNet and throttle #1 sends a command, the command station sees it and executes immediately. With a distributed network like LocoNet, new features can be added by simply plugging in new hardware or software. Since LocoNet is a peer to peer network, devices on LocoNet can act independently of the command station, too. Feedback is incorporated in LocoNet's communication scheme so you don't need to wire a separate feedback bus or layout control bus.

Other systems typically use polled buses or "networks." In this case, the command station must "ask" each of the throttles or other devices in turn: "Do you have input for me?" The device must wait for the command station to poll all the devices on the bus before it sends the command. This arrangement can slow down response times and limit the number of devices that can be handled by the system as more and more devices are added. With centralized processing in a master/slave control type system like this, adding new features usually means updating the command station software when new components are added since devices can't operate on the system unless the master command station knows how to handle them. To add feedback capabilities to this type of system, a separate feedback bus may also be necessary.

5.3 Network Speed

Is faster network speed better? Not necessarily, it depends on whether the system uses event driven or polled architecture. The NMRA's track control packet format sets the "speed limit" for all DCC systems. Going faster than the "speed limit" won't make a system work any better and causes problems on the network.

LocoNet is engineered for the lowest speed that will get the job done. Because LocoNet is event driven, slower network speeds are possible. With slower network speed, signal distortion on the network is not a problem. Because LocoNet uses a slower network speed, it's free-form wiring scheme is simple and flexible. With LocoNet you can "branch" or "tee" anywhere in your network wiring and no termination is needed.

Polled systems generally have to go a lot faster than the "speed limit" to accommodate the large amount of traffic generated by polling and to prevent delays between the time a command is issued by the throttle and the time the system executes the command. The big problem is that as the network speed increases, so does signal distortion. Polled systems generally use linear terminated bus wiring to solve this problem. Free-form wiring like LocoNet is not usually possible with polled systems.

5.4 LocoNet Personal Edition

LocoNet Personal Edition is available to all model railroaders through our web site. This edition of LocoNet is available so that you can develop your own personal non-commercial LocoNet applications.

5.5 LocoNet Expansion for Complete Train Control

The following figure shows some of the expansion possibilities available with LocoNet. Many different combinations of hardware will work, not all combinations will have all features available. This figure is an extension of the DCS210 setup in Section 1.0. With LocoNet you can add:

- More boosters to give you more power to let you run more trains,
- More throttles for more operators,
- Different types of throttles,
- More throttle jacks for convenient walk-around operation,
- Infrared or radio capability for more freedom for operators,
- Accessory decoders for turnout and accessory control,
- Detection,
- Transponding,
- Signaling,
- A personal computer to automate operations or for dispatching,
- Automatic reversing with a booster or power manager,

With LocoNet, you customize your layout to run the way you want it to run!

5.6 LocoNet Wiring Components

Connecting the LocoNet components is easy to do. Digitrax LocoNet devices are connected using 6-conductor cables with RJ12, 6-pin connectors.

Making your own LocoNet Cables is simple and cost effective. However, we offer Digitrax Pre-Made Pre-Tested LocoNet Cables in a variety of lengths. Cable Maker kits and additional cabling supplies are also available. Other electronic suppliers also have these components available.

We recommend using the LT1 tester that came with your DCS210 to test the cables to be certain they are good before installing them. Many layout problems we see are related to LocoNet cables that were not built or crimped correctly or that have become damaged.

LocoNet can support a total cable length of up to 2,000 feet with no two devices connected by more than 600 feet of cable. LocoNet wiring is totally free-form. We do not recommend looping LocoNet back on itself.

5.7 Making LocoNet Cables

We use the following wiring convention for all LocoNet cables and connections:

Pin #	Wire Color	Name
1	White	Rail Sync +
2	Black	Ground
3	Red	LocoNet
4	Green	LocoNet
5	Yellow	Ground
6	Blue	Rail Sync -

LocoNet cables are wired pin 1 to pin 1. When you hold the plug with the tab up and look into the end of the connector you will see the wires listed above starting at the left side and moving to the right. (This is sometimes called a “reversing cable” in the telecom industry even though it really does not reverse the connection.)



5.8 Testing LocoNet Cables with an LT1

1. Disconnect the wire harness from the LT1.
2. Plug one end of the LocoNet cable being tested into the LT1.
3. Connect the other end to any powered Digitrax booster LocoNet Jack A, B, or C. Be sure you have at least one Digitrax throttle connected to LocoNet.
4. All four LEDs on the LT1 will light if the cable is good. LEDs may not all be the same brightness, this is normal.
NOTE: Only three LEDs will light if no LocoNet throttle is plugged in to the system.
5. If any of the LEDs fail to light, re-crimp the plugs on the LocoNet cable and retest.

5.9 LocoNet Throttle & Connection Jacks

Digitrax LocoNet devices are connected using 6-conductor LocoNet cables. All LocoNet devices have LocoNet Connection Jacks that allow you to daisy chain the network around the layout.

Some Digitrax devices like the Universal Panels also have LocoNet Throttle Jacks. The Throttle Jacks should not be used for connecting LocoNet devices that will be daisy chained beyond themselves or that use rail sync. You can use these jacks for throttles and other accessory devices not requiring rail sync. Consult the installation instructions for the particular device you are installing to determine whether it can use the Throttle jacks or if a Connection jack is necessary.

All Digitrax throttles are memory walk-around throttles, some are equipped with infrared LEDs and others are radio throttles. Even if you use wireless throttles, you will still need to install at least one or two LocoNet throttle jacks on your layout. Any RJ12 6 conductor phone jack can serve as a LocoNet throttle jack. The problem with using RJ12 telephone style jacks is that you will have to wire them and secure them to the layout so that they don't come loose. Digitrax Universal Panels are very cost effective and typically perform better.

5.10 Installing the Universal Panel (UP5)

The Digitrax Universal Panel UP5 or UR92, included with your Evolution Starter Set, provides a simple plug and play alternative to wiring RJ12 telephone style jacks around the layout. This fascia mounted panel provides 2 RJ12 LocoNet throttle jacks as well as a "TRACK STATUS" indicator on the front panel. The back of the panel provides 2 RJ12 LocoNet connection jacks for daisy chaining to the next LocoNet device on the network. An additional RJ12 throttle jack is provided on the side of the UP5 for connecting additional throttles or LocoNet devices. The panels provide a professionally finished look to your layout fascia. UP5, UR90 (infrared receiver), and UR92 (duplex radio

transceiver) all provide additional LocoNet Throttle Jacks and Connection Jacks for your system.

UP5 Panel Assembly

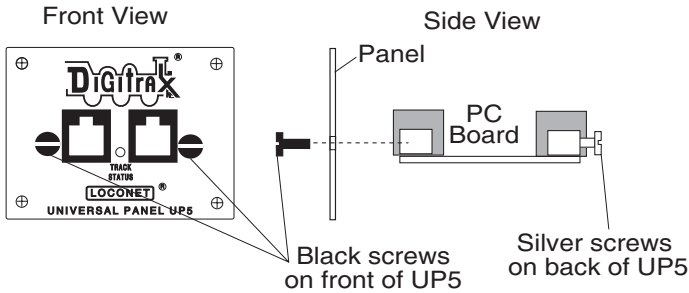

UP5 Assembly and Hook-up

5.10.1 Hooking up the UP/UR's Track Status Indicators (Optional)

The figure below shows how to hook up your UP panel on your layout. Instructions are also included below for hooking up the TRACK STATUS indicator. This is an optional feature and the UPs will work just fine even if you do not hook up the TRACK STATUS indicator to the local track section.

Using one or more UR90, UR91, UR92, or UP5 with a single external DC power supply

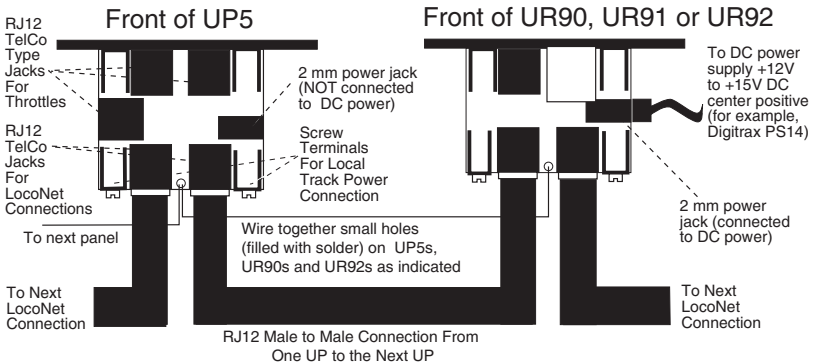

Note: You can run up to 10 UP or UR panels with a single DC power supply by simply connecting the small holes on each panel as indicated in this diagram.

The UP5's, UR90's, and UR92's TRACK STATUS Indicators are bi-color LEDs that show the status of the local track section to which it is attached. **If you are using track detection, do not hook up TRACK STATUS indicators directly to the track bus.** To hook up the TRACK STATUS indicator follow these steps:

1. Attach an 18-26AWG wire to one of the screw terminals on the back of the UP/UR and connect the other end to either rail.
2. Attach another 18-26AWG wire to the other screw terminal on the UP/UR and connect it to the other rail of the track.
3. If you are hooking up more than one UP/UR, be consistent in hooking up all track sections alike with respect to which terminal is connected to which rail. This is not required but strongly recommended.

As you operate your layout, the UP/UR TRACK STATUS Indicator will be lit when the track is powered. The LED glows red or green when you are operating an analog locomotive and the system is “zero stretching.” When you are using DCC only, the LED will glow orange. This color change is a useful diagnostic tool.

Now that you have learned more about LocoNet and how to connect the devices using LocoNet cables, let look at installing Digitrax on your layout!

6.0 Advanced Installation On Your Layout

Early proponents of DCC touted the fact that you can hook up your railroad with just two wires. While this is technically correct, there are some things you will need to consider to get the most out of Digitrax Complete Train Control.

Because the signal and the power that runs the trains are one in the same, you must provide adequate power to all areas of your layout for reliable Digitrax operation. ***If the decoder in the locomotive does not see track power, it will not see the signal and it won't run.*** Digitrax boosters need enough track power to sense short circuits to operate properly. Your layout must have a power bus and feeder system that can safely support the continuous full current rating of any booster anywhere on the layout.

Unless you need to set up power districts on your layout for added power, the only gaps you need are for hard shorts like reverse loops and uninsulated frogs. If you are already wired for block control, you probably don't need to rewire. Just open all your blocks so that the entire track has power and you are ready to go. If you are using common rail wiring, we recommend that you divide the layout into power districts by double gapping between power districts.

6.1 Setting Up A Programming Track

Decoders are programmed when the command station sends programming information to them through the rails. There are two ways of programming decoders.

6.1.1 Ops mode programming

Ops mode programming (*see section 16.3*) is done on the layout with programming directed to a specific decoder address on the layout tracks. Operations mode programming is used to make changes to locos while they are running on the layout.

6.1.2 Service mode programming

Service mode programming broadcasts a message to all decoder equipped locos that are on the programming track. Because this is a broadcast method and will affect all locos, you will need to set up a programming track so that the programming instructions only go to the loco you want to program.

Your DCS210 sends these programming commands using the Program A(PA) and Program B(PB) outputs. See the following figure for hook up information. Program A(PA) and Program B(PB) are actually a second set of outputs that allow you to program decoders while still running the layout on the RAIL A(RA) and RAIL B(RB) outputs. You will need to set up a programming track for service mode programming that will allow you to program a loco without shutting down the rest of the layout during programming. *Follow the steps outlined in Section 16.0 to program your decoder equipped locomotives.*

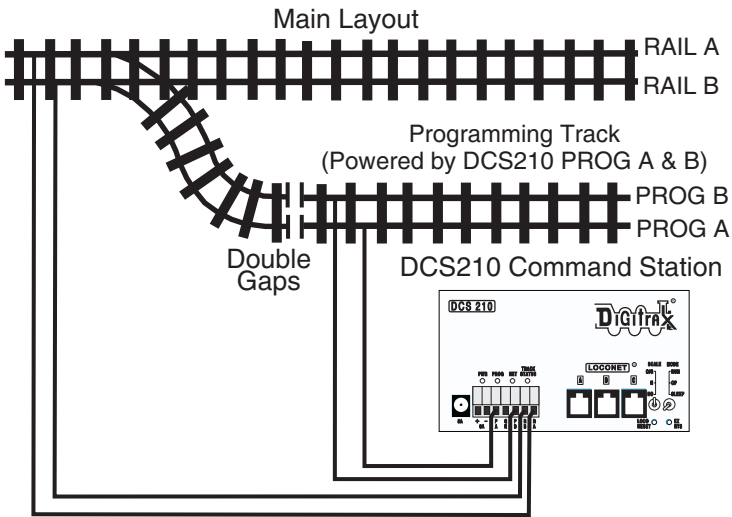

NOTE: Some wiring omitted for clarity

Programming Track With DCS210

6.2 Direct Home Wiring vs. Common Rail Wiring

Digitrax strongly recommends direct home wiring where each power district and its booster are electrically isolated. This type of wiring is safer and more convenient to work with for debugging and for adding reversing sections and detection. *If you are planning to use whole layout common rail wiring you will need to order opto-isolated boosters for your layout.*

Note for detection and signaling wiring common rail can be used within power districts that are wired for direct home and use regular Digitrax boosters.

6.3 Recommended wire sizes

On an average size layout Digitrax recommends that the power bus from the booster be at least 16AWG. When feeding areas up to 50' from the booster, we recommend using 12AWG wire for the power bus.

From the main power bus, we recommend dropping feeders (22-24AWG) approximately every 6 to 10 feet of track. Sets of feeders should be wired to both rails and we recommend at least 2 sets of feeders per power district.

The wire gauge used (AWG) can be increased or decreased, depending on your actual layout dimensions and operating power/current loads. *The wire gauges used should be sufficient so that track short circuits are reliably detected on the whole layout.*

6.4 Other Track Wiring Considerations

1. Power connections to a large layout should be via a parallel conductor power bus similar to that used in most conventional layouts, with feeder wires to the track about every 6-10 feet.
2. When using more than one booster, be sure that the RAIL A(RA) and RAIL B(RB) connections for all boosters are made in the same track orientation, i.e. RAIL A(RA) to left rail and RAIL B(RB) to right rail or vice versa.
3. Do not short either the RAIL A(RA) or RAIL B(RB) output of the DCS210 to GROUND.
4. To minimize the possibility of radio interference, twist all conductors.
5. Circulating ground loops may cause problems with your layout. We often see this on existing layouts that have been added to over the years. If you are experiencing problems in a localized area of your layout, you may need to look for this problem and fix it.
6. Wire the power feeds away from the boosters and command stations, in a radial "star like" configuration to minimize the possibility of creating "magnetic induction" loops.
7. **Do not place ANY filters or capacitors across the track.** These will short out the control signals. Be sure that no capacitors are bridging your power districts.

6.5 Layout Power Districts

A power district is an electrically isolated section of the layout including the power wiring, booster and power supply that drives it. Power districts are used for power distribution, not for train control as with DC blocks. Power districts may be divided into sub-districts for short circuit management within the power district or for auto reversing. Even though blocking is not required for train operation with DC, dividing the layout up into power districts (and sub-districts) is needed for the following reasons:

6.5.1 Number of Locos

Additional power districts may be needed to provide enough power to operate more locomotives than one power supply alone can handle. For example a 5 amp booster and power supply will operate between 10 and 15 average N-scale locomotives and between 6 and 10 HO locomotives. If you wish to run more locos on your layout, then you will need to set up more power districts to provide more total power.

6.5.2 Short Circuits

Additional power districts and sub-districts can be used to prevent the whole layout from shutting down when short circuits (like de-rails or an operator running a switch) occur in any given power district or sub-district. If a short occurs in one district or sub-district, only that area of the layout shuts down, the rest of the layout keeps operating.

6.5.3 To set up power districts & sub-districts:

1. Determine how you want to arrange power districts and sub-districts.
2. Double gap the rails at each end of the power district and single gap for sub-districts within districts.
3. Connect a Digitrax booster and power supply to each district. Use a Digitrax Power Manager (PM42, etc.) with your booster to set up sub-districts.
4. Connect the Digitrax boosters to the command station via LocoNet.

6.5.4 Do I have enough power to run my trains?

Use the “quarter trick.” Once your Digitrax command station and booster(s) are installed and the layout is powered up, use a quarter (or other piece of conductive material) to short both rails at various places on the layout. If you have enough power at that location, the booster for that power district will chirp and shut down. If the booster does not shut down, then you need to add more feeders to allow reliable short-circuit detection.

6.6 Adding a Booster

Your DCS210 is a command station and booster in one unit. The DCS210 is not intended to be used as a booster only. When you are ready to expand your DCS210, we recommend that you add a Digitrax Booster (DB150, DB200+, etc.). Be sure that you follow the directions that come with your Booster to insure that it is properly configured as an Expansion Booster.

If you experience problems with operation after you add a Booster to your system, check to be sure that you have actually set it up as a booster by double checking the booster manual. We have seen this simple mistake cause operating problems with modular layouts when someone added a booster set up as a command station to a layout that was already up and running with another command station. In this case, two command stations can be trying to run the same layout causing some undesirable operating results such as trains that

appear to be running away. The DCS210 has automatic Command Station collision detection. If the DCS210 detects another command station on LocoNet it will issue 10 long beeps and turn off track power. The DCS210 will not allow track power to be turned back on until the offending Command Station is removed from LocoNet or configured properly as a booster.

6.7 Reversing Section Wiring

You can operate reversing sections automatically with Digitrax Complete Train Control using an auto-reversing booster or a reversing section controller such as an AR1 or PM42. You must double gap (completely isolate) both ends of the reversing section just like with any other layout. Note that automatic reversing will not cause analog (non decoder equipped) locos to auto reverse.

To handle auto reversing, you need two devices, one that acts as the system polarity reference and another to detect a polarity mismatch and correct it. For example, if you are using two Digitrax boosters, one acts as the polarity reference and the other handles the polarity reversal for the reversing section. You can also use a DCS210 and PM42 to handle automatic reversing sections.

Note that when the polarity change occurs, decoder equipped locomotives will continue at the speed and in the direction commanded but any analog engines running will respond to the polarity change by reversing direction.

A single Auto Reversing Booster can be used to handle more than one reverse section however, the unit can only fix a polarity mis-match at one gap at a time. If more than one train is entering or leaving the reverse loops connected to a single booster at the same time, a short will occur. More than one train can be in the reverse loop at any time but, only one can cross a double gap at a time.

6.8 Power Managers for Sub-Districts & AutoReversing

If you want the benefits of setting up power districts on your layout but you don't need to add more power to run more trains, you can use a Power Manager like the PM42 to set up sub-districts within booster power districts. With a Power Manager you can separate the output of one or more boosters into multiple sub-districts that can be set up as either auto-reversing or as smart circuit breakers for short circuit management. For more information about this option check our web site at www.digitrax.com.

6.9 Using AR1 for AutoReversing

If you have a single reversing section that doesn't need its own booster, you can use the AR1 single unit auto reverser to set up a reversing section.

6.10 Troubleshooting Layout Wiring

Installing Digitrax, or any other layout control system, on your layout will not fix problems with layout wiring. Layout wiring can be very complex. We see many examples of layouts that have "grown over the years" where wiring was added and changed creating some very interesting electrical systems. If you suspect that layout wiring might be a problem, we recommend that you dis-

connect the Digitrax equipment from the layout and test it on a small section of track not connected to the layout to confirm that the problem is not with your Digitrax equipment. If you find that there is a problem with your Digitrax equipment, contact Digitrax tech support. If you find that your Digitrax equipment is working fine, then it is time to de-bug the layout.

Observe the problem carefully and methodically.

Does it occur with both DC and DCC operation?

If so, check track wiring.

Is it occurring everywhere on the layout or in one particular area?

With your Digitrax system hooked up, a coin or screwdriver to short out the track. If no short occurs, you may not have enough feeders or your power supply may not be adequate. Use your LT1 to test the LocoNet cables attached to the booster in the problem area.

Does it only occur with certain locomotives?

Check the locomotives for mechanical problems and for damaged decoders. If you programmed the decoders just before the problem started, re-program them in case you entered values by mistake that are causing the problem.

Does it only occur with certain throttles, boosters or other equipment?

If the problem happens with just one piece of equipment, then you may need to have it repaired. Check the RJ12 jacks to be sure the pins are not misaligned.

Does it occur only when plugged into a certain LocoNet jack?

Check the wiring to that jack, particularly if you are using telco type jacks that you wired yourself. Use your LT1 to test the LocoNet cable you are using in that area of the layout.

Have you recently changed anything in your layout wiring? If so, try disabling the change to see if they layout will run without the “upgrade.” You may need to debug the upgraded wiring.

Have you changed any of the Command Station or Throttle option settings? Try resetting them to the default values and check to see if the layout will run.

Have you recently installed additional boosters on your layout?

If so, check to be certain that these boosters are set up properly as boosters. If more than one command station is operating on your layout, you may experience unexpected operation when the decoders are taking commands from two different sources (command stations.)

If you have two separate operating LocoNets and you connect them with a LocoNet cable, both command stations can continue to operate and operating problems can occur. Modular layouts are at a high risk of encountering this problem if more than one part of the layout is up and running and then those parts are added together. Be sure in this case that you completely power down

all operating LocoNets before combining them into one big LocoNet.

The DS240 helps eliminate this issue with automatic command station collision detection. If the DCS210 detects another command station on LocoNet at power up or during periodic 2 minute checks, it will issue 10 long beeps and turn off track power. The DCS210 will not allow track power to be turned back on until the offending Command Station is removed from LocoNet or configured properly as a booster.

7.0 DCS210 Control Panel

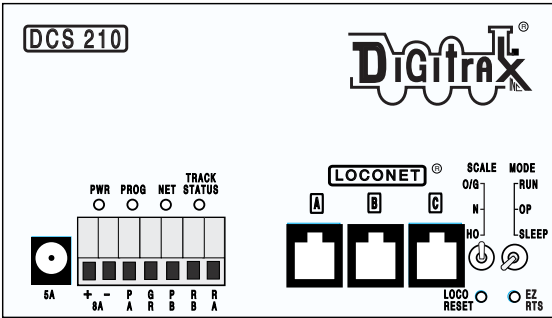

7.1 Power (PWR) Indicator

This LED indicates there is power supplied to the DCS210. It will light either green (command station mode) or red (booster mode). The PWR indicator will light GREEN or RED winking off every 3 seconds as a “Heartbeat” when the unit is in RUN mode. *See Section 7.17 for full light (LED) indication list.*

7.2 Power In Barrel Plug (5A) or Terminals (“+” and “-“ 8A)

The DCS210 may be powered either using the barrel plug connector or the screw terminals labeled “+” and “-“. The barrel plug connector is only rated for a maximum of 5 amps and is for use with the PS615. The screw terminals can be used with any suitable power supply up to the unit’s maximum 8 amps. Make sure your DC power supply is rated for your desired voltage and amperage. When using the screw terminals make sure that the polarity of the power supply matches the correct terminals on the connector. The DCS210 is reverse input protected, however it will not power on if the DC polarity is incorrect.

The DCS210 is for use with DC POWER input ONLY, MAXIMUM INPUT 8 AMPS, 24VDC, 192 VA MAXIMUM CONTINUOUS, DO NOT Exceed 25VDC maximum Input. Minimum Input 13VDC.

There are many DC power supplies that can supply the input power for the DCS210. Most regular DC model railroad power packs are not able to supply sufficient amperage to the DCS210, because they were designed to run only 1 or 2 locomotives in a DC blocked system. With Complete Train Control you’ll be running multiple locomotives in the same power district so, you’ll need to provide more power to each district.

It is recommended that when selecting a DC power supply the voltage should slightly exceed the track voltage you plan to run your layout at. However, the DC input voltage should not exceed track voltage by more than 3V. The PS615 provides 15VDC and is suitable for the N and HO default voltage settings of the DCS210. If the DC supply voltage exceeds track voltage by more than approximately 3V the DCS210 will enter Safe Operation Mode see Section 7.11.3.

NOTE: Please visit our website for special wiring considerations when using the PS2012 to power your DCS210.

Power to the DCS210 should not be rapidly cycled ON-OFF-ON. When power to the unit is switched off, wait 30 seconds before turning on the power again.

7.3 Program A and B terminals (PA and PB)

The PA and PB terminals are the output for the second set of command signals for the programming track that can be used while the rest of the layout continues to run.

7.3.1 Program A(PA) and B(PB) terminals as a Braking Section

PA and PB can also be used with an additional booster to set up braking sections on your layout. This is useful if you want to stop trains at given points on the railroad, for example at a station. Instructions for setting up brake sections can be found on our web site, www.digitrax.com/brakesection/.

7.4 Program (PROG) Indicator

The PROG indicator will blink red when the program track is active.

7.5 Ground (GR) Terminal

The terminal marked ground provides electrical safety features and an RF ground reference for minimum radiated noise. This should be the ONLY point of any DCS210 installation that is connected to the AC safety ground pin provided on most 3 pin 110V AC power sockets. Grounding the system is a sensible safety precaution that should not be ignored.

7.6 Rail B (RB) and Rail A (RA) Terminals

Connect these terminals to the track sections powered by the DCS210. If you are using more than one booster, be sure to use double gaps between each section and always connect the same rail to the same terminal on each booster. For example connect all Rail A terminals to the right rail and all Rail B terminals to the left rail or vice versa on all track sections.

7.9 TRACK STATUS Indicator

The TRACK STATUS indicator shows that there is voltage on RAIL A and RAIL B terminals. The indicator will be lit when there is track voltage, and not lit when track voltage is off. The indicator will change color indicating various degrees of “Zero Stretching” used to operate a conventional (analog) locomotive.

7.10 LOCONET Jacks A, B and C

These jacks let you expand your Digitrax system by simply plugging LocoNet devices in to the system. They can be used for throttles and other LocoNet devices. These jacks are functionally the same and can be used interchangeably.

7.11 SCALE Switch (O/G, N, HO)

This switch sets the nominal track voltage.

7.11.1 DCS210 Voltage Trim Settings.

The DCS210 is capable of custom voltage output ranging from approximately 8v to 24v with a suitable power supply. Each of the 3 scale settings can be trimmed to a custom voltage setting.

The following ranges correspond with each track setting:

	Nominal Voltage default	Nominal Voltage @ max decreased trim	Nominal Voltage @ max increased Trim
O/G	20.4v	18v	24v
HO	14.7v	14.5v	18v
N	12.4v	9v	14.5v

Note: The DCS210 can only OUTPUT approximately as much voltage as it is receiving. Using the PS615 15VDC power supply the maximum voltage provided will be approximately 15V. Higher voltages will need a different DC power supply. Use a power supply that approximates your planned track voltage.

The DCS210 is for use with DC POWER input ONLY, MAX INPUT 8 AMPS, 24VDC, 192 VA MAX CONTINUOUS, DO NOT Exceed 25VDC Input.

To Adjust Voltage Trim:

1. Set Mode Switch to OP. PWR indicator will flash GREEN alternating with the PROG indicator flashing RED.
2. Press the LOCO RESET button. The unit will start beeping continuously.
3. Select Address 00 on a throttle plugged in directly to the DCS210.
4. Set Scale Switch to the Scale voltage you wish to adjust.
5. Using the Throttle with 00 selected, adjust Forward Speed to increase Voltage trim up above default. Adjust Reverse Speed to decrease voltage trim down below default.
6. The voltage can only be adjusted up or down by the range referenced in the chart above. The DCS210 will beep continuously as long as it is in range. When you reach a value that is out of range the DCS210 will stop beeping. Once you decrease the trim UP or Down the DCS210 will beep again once you are in range.
7. To determine the actual track voltage, measure the DC voltage (unloaded) from Rail A to Ground and Rail B to Ground, then add the two values together.
8. Once you have set your desired voltage press the EZ RTS button and the DCS210 will beep once indicating the trim setting is saved. If the button is not pressed voltage changes will be discarded. You may select a different scale and set its trim in the same manner as above before exiting Voltage Trim Mode.
9. To exit Voltage Trim Mode set the Mode switch to RUN.

To Reset to Voltage default:

1. Set Mode Switch to OP. PWR indicator will flash GREEN alternating with the PROG indicator flashing RED.
2. Press the LOCO RESET button. The unit will start beeping continuously.
3. Select Address 00 on a throttle plugged in directly to the DCS210.
4. Set Scale Switch to the Scale voltage you wish to reset.
5. Using the Throttle with 00 selected set speed to 0.
6. Press the EZ RTS button the DCS210 will beep once indicating the trim setting is saved. If you wish to reset other scales voltages repeat steps 4 thru 6.
7. To exit voltage trim adjust set the Mode switch to RUN.

Note: Voltage trim values for all scales will reset if OpSw40 (factory default) is Closed. All other settings will be reset to defaults.

7.11.2 Heat Dissipation

It is normal for the DCS210 to be warm to the touch when it is in use. It is designed to absorb and dissipate the power difference between the input voltage and the selected scale output stabilized voltage, at the current load being drawn. If the unit is not able to dissipate excess heat, over temperature thermal shutdown may occur. When the DCS210 experiences a over-temperature shutdown, the booster will turn off and the DCS210 will beep and the PWR indicator will flash alternating GREEN/RED once a second. We recommend that you locate the unit in a location where it can dissipate heat. If you experience frequent over temperature shutdowns, you can add a small fan to increase airflow over the rear heat sink and cool the DCS210.

7.11.3 Troubleshooting DCS210 Shutdowns

1. Move the DCS210 so that the heat sink has a flow of cool air.
2. Place the DCS210 out of direct radiant heat like sunshine or a room heater.
3. Try direct cooling by using a small fan to blow air onto the heat sink.
4. Lower the track load current.
5. Reduce the input voltage from the power supply.

If the DCS210 beeps 4 times and shuts down briefly and then comes back on again, it is probably being run too close to its pre-set current limit. In this case it may clip or mutilate some outgoing packets to keep the track current within acceptable limits. To solve this problem, reduce the track current load by setting up additional power districts to provide more total power for the layout.

7.11.4 DCS210 Safe Operation Mode

We recommended when selecting a DC power supply, that the voltage slightly exceed the track voltage at which you plan to run your layout. The PS615 is suitable for the default N and HO scale settings on the DCS210. If you want to run at a higher voltage the DC input voltage should not exceed track voltage by more than 3V. If the DC supply voltage exceeds track voltage by more than approximately 3V the DCS210 will enter Safe Operation Mode and proportionally lower the maximum current limit.

In safe operation mode the DCS210 will limit the current available to power the track in order to prevent damage to the DCS210. When the DCS210 is in safe operation mode the PWR indicator will wink off 2 times every 4 seconds. To avoid your DCS210 entering safe operating mode and get the full 5 or 8 amps of power, your power supply voltage should not exceed your track voltage by more than approximately 3V.

7.12 MODE Switch

The MODE switch settings are:

- RUN normal operations.
- OP customize the DCS210 by changing its option switch settings.
- SLEEP shutdown the system and all throttles that are plugged in to the system.

7.13 NET Indicator

The NET indicator is a red LED that displays information about what the DCS210 sees on LocoNet. When your layout is wired correctly and LocoNet is operating properly, the NET indicator will be on and it will wink off any time a good LocoNet message is detected by the DCS210. The table below explains the patterns you will see for this indicator.

NET LED Indication	Meaning
Solid Red	LocoNet OK
On, wink off	DCS210 detects a valid LocoNet message
Off	DCS210 detects low voltage on LocoNet

7.14 LOCO RESET Button

The LOCO RESET button allows you to clear all decoder info and consists from your DCS210. Pressing this button preforms the same function as closing OpSw 36. This button is useful in clearing all locos from the system after a large operating session or if you are getting a slot full error. This button can also be configured to activate Slot Zero, where all locomotives are set to 0 speed and all functions are turned off. See Section 10.11 for more details.

7.15 Easy Routes (EZ RTS) button

The EZ RTS button give your simple access to setting up routes in your DCS210. For information on setting up routes refer to the Routes section 14.4

7.16 DCS210 Audible Sounds

The DCS210 uses several beeps and clicks that can be used as diagnostic tools that help you debug a number of conditions. Some Audible sounds mean different things depending on the DCS210's current mode.

Sound	Meaning
Continuous short beeps	In Voltage Trim Mode, selection is in range.
1 Short Beep	Diagnostic Beep when OpSw41 = c, LocoNet commands incoming. In EZ routes mode indicates a switch has been saved. During operation, DCS210 has recovered from a fault
2 Short Beeps	Initial DCS210 Power on or DCS210 had purged a loco address
3 Short Beeps	Entered quick routes mode
4 short Beeps	Booster short circuit shutdown.
5 Short Beeps	Route Error, looping route
8 Short Beeps	Route Error, Maximum switch commands issued.
1 Long Beeps	In EZ routes, initial Route ID saved
2 Long Beeps	In EZ routes, route saved and exit EZ Routes
3 Long Beeps	When pressing the Loco Reset Button, all loco addresses purged from the system.
4 Long Beeps	Input Voltage is out of the range 13.8V to 24V DC
10 Long Beeps	DCS210 has detected another Command Station on LocoNet and has turned off track power.

DCS210 AUDIBLE SOUNDS

7.17 DCS210 Indication Lights

The DCS210 uses different combinations of the PWR, PROG, NET, TRACK STATUS, and USB indicators to provide information. The indicators can show what mode the DCS210 is in as well as indicate errors and operations.

Indications	Meaning
PWR GREEN winking off every 3 seconds as a “Heartbeat”	The DCS210 is powered on in Command Station Mode, Normal Operation Mode.
PWR RED winking off every 3 seconds as a “Heartbeat”	The DCS210 is powered on in Booster Only Mode, Normal Operation Mode.
PWR off blinking on GREEN or RED every 4 seconds	The DCS210 is in SLEEP mode. (GREEN = Command Station Mode) (RED = Booster Only Mode)
PWR flashing RED, all other indicators off	Input Voltage out of Range 13.8V to 24V DC.
PWR flashing GREEN	DCS210 Internal fuse blown, replace fuse.
PWR RED or GREEN winking off 2 times every 4 seconds	The DCS210 is in Safe Operation Mode. Check your power supply to make sure it is appropriate for your track voltage settings. (GREEN = Command Station Mode) (RED = Booster Only Mode)
PWR flashing GREEN alternating with PROG flashing RED	The DCS210 is in Options Switch Mode.
PWR flashing alternating GREEN/RED once a second	The DCS210 is overheated and has shutdown.
PWR flashing Green alternating with NET flashing RED slow, about once a second	The DCS210 is updating IPL firmware Via LocoNet.
PROG blinking RED	The DCS210 program output is active.
PROG blinking RED slow, once a second	DCS210 is in EZ Routes mode.
TRACK STATUS is lit	Indicates there is power to the track. This indicator will be GREEN or different shades of Yellow/Orange depending on Zero Stretching.
NET indicator Solid RED on	LocoNet OK.
NET indicator Solid on RED, wink off	DCS210 detects a valid LocoNet message.
NET indicator off	DCS210 detects a low voltage on LocoNet.

DCS210 INDICATION LIGHTS

8.0 Customizing DCS210-Option Switch Setup

The Option Switch (OpSw) setup allows you to customize the operation of the unit to meet your layout and operation preferences. The DCS210's power up defaults are fine for most applications and the DCS210 will run "out of the box."

8.1 Changing DCS210 Option Switches

1. See the Option Switch Table below to decide which option switches you want to change.
2. Move the MODE toggle switch on the front of the DCS210 into the "OP" position. The LocoNet Railsync will go inactive and all other boosters plugged in to LocoNet, including the one that is built into the DCS210, will shut down. The PWR indicator will flash GREEN alternating with the PROG indicator flashing RED.
3. Disconnect LocoNet from the DCS210 you are configuring.
4. Connect your DT4xx or later throttle directly to either DCS210 LocoNet A,B, or C.
5. Press the **SWCH** key on your throttle to enter Sw (Switch) mode. Since the DCS210's MODE toggle switch is set to "OP", switch commands from your throttle will now control DCS210 internal option switch settings instead of the accessory decoders (usually turnouts) on the layout.



6. Key in the number of the OpSw. In the example above, we have keyed in 6. As you browse through the OpSws, the right side of the text area will show the current setting for each OpSw, either "c" or "t".
7. Use the **CLOC / c** key to set the OpSw to **c** (closed) or the **OPTN / t** key to set the OpSw to **t** (thrown). In the example above we have changed OpSw 6 from its factory setting of **t** to **c**.
8. Exit DCS210 Option Switch Mode by moving the MODE toggle switch on the DCS210 to "RUN." Remember to reconnect LocoNet to the DCS210. Track power will resume to the state it was in when you entered Option Switch Mode.

Note: Do not adjust any Op Switches marked "Do Not Change"

These option switches are reserved and changing them may cause problems with your system. Do not change any option switches not listed in the table below.

Special Instructions for DCS210 Op Switches 36, 37,39 and 40

For these Op Switches to work properly,

1. Set the OpSw to “**c**” by pressing the **CLOC / c** key.
2. Set the DCS210’s MODE Switch to “SLEEP” mode.
3. Set the DCS210’s MODE Switch back to “RUN” mode.
4. The operation will occur (data will be cleared) and the option switch will reset to “**t**”.
5. Your throttle display will still show “**c**” even though the reset has occurred.
6. The display will update the next time you access the OpSw.

8.2 DCS210 Option Switch Tables

The following tables provide a list of the DCS210 Option Switches and the impact of the change on the system.

Option Switch #	Effect on System operation	Factory Default
OpSw 01	Do Not Change	t
OpSw 02	t = Command Station Mode	t
	c = Booster only Mode (not recommended)	
OpSw 03	t = DCS210's booster normal	t
	c = DCS210's booster is auto reversing	
OpSw 04	Do Not Change	t
OpSw 05	Do Not Change	t
OpSw 06	t = check for decoder before programming	t
	c = program without checking for a decoder	
OpSw 07	Do Not Change	t
OpSw 08	Do Not Change	t
OpSw 09	Do Not Change	c
OpSw 10	Do Not Change	c
OpSw 11	Do Not Change	t
OpSw 12	Do Not Change	t
<i>DCS210 Option Switch Tables</i>		

Option Switch #	Effect on System operation	Factory Default
OpSw 13	t = Loco address purge time 200 seconds	t
	c = Loco address purge time 600 seconds	
OpSw 14	t = Loco address purging enabled	t
	c = Loco address purging disabled	
OpSw 15	t = Purging will not change loco speed	t
	c = Purging will force a loco to 0 speed	
OpSw 16	Do Not Change	t
OpSw 17	t = Automatic advanced decoder assisted [FX] consists are enabled	t
	c = Automatic advanced decoder assisted [FX] consists are disabled	
OpSw 18	t = Normal DCS210 booster short circuit shutdown time	t
	c = Extended DCS210 booster short circuit shutdown time	
OpSw 19	Do Not Change	t
OpSw 20	t = Enable address 00 or analog stretching for conventional locos	t
	c = Disable address 00 or analog stretching for conventional locos	
OpSw 21	OpSw 21-23 set the global system default type for “NEW” loco selections. SW21/22/23 set as follows: c-c-t = 128 step mode c-c-c = 128 step FX mode t-c-t = 14 step mode t-t-t = 28 step	c
OpSw 22		c
OpSw 23		t
<i>DCS210 Option Switch Tables</i>		

Option Switch #	Effect on System operation	Factory Default
OpSw 24	Do Not Change	t
OpSw 25	t = enable Route echo over LocoNet	t
	c = Disable Route echo over LocoNet	
OpSw 26	t = Disable routes	c
	c = Enable routes	
OpSw 27	t = Enable normal switch commands, a.k.a. the “Bushby bit”	t
	c = Disable normal switch commands, a.k.a. the “Bushby bit” Allows attached PC to handle switch control logic	
OpSw 28	t = Enable interrogate commands at power on	t
	c = Disable interrogate commands at power on	
OpSw 29	Do Not Change	t
OpSw 30	Do Not Change	t
OpSw 31	t = Normal route/switch output rate when not trinary	t
	c = Fast route/switch output rate when not trinary	
OpSw 32	Do Not Change	t
OpSw 33	t = Track power off at power on	c
	c = Allow track power to restore to prior state at power on	
OpSw 34	t = Disallow track to power up to run state, if set to run prior to power on	t
	c = Allow track to power up to run state, if set to run prior to power on	
<i>DCS210 Option Switch Tables</i>		

Option Switch #	Effect on System operation	Factory Default
OpSw 35	t = Enables Loco Reset Button	t
	c = Disable Loco Reset Button	
OpSw 36*	c = Clears all mobile decoder info & consists	t
OpSw 37*	c = Clears all routes	t
OpSw 38	t = Loco Reset Button activates OpSw39	t
	c = Loco Reset Button activates Slot Zero (see section 10.11)	
OpSw 39*	c = Clears all internal memory states, including OpSw 36 & 37.	t
OpSw 40*	c = Clears all internal memory states and sets Voltage Trim to default. Resets DCS210 to factory default	t
OpSw 41	t = Diagnostic click disabled	t
	c = Diagnostic click when valid LocoNet commands incoming & routes being output	
OpSw 42	t = Enable 2 short beeps when loco address purged	t
	c = Disable 2 short beeps when loco address purged	
OpSw 43	t = Enable LocoNet update of command station's track status	t
	c = Disable LocoNet update of command station's track status	
OpSw 44	Do Not Change	t
OpSw 45	t = Enable reply for switch state request	t
	c = Disable reply for switch state request	
OpSw 46	Do Not Change	t
<i>DCS210 Option Switch Tables</i>		

Option Switch #	Effect on System operation	Factory Default
OpSw 47	t = Normal Program Track Setting	t
	c = Program track is brake generator when not programming. Braking is DCC set to speed 0 (not Emergency stop) for address 0, light ON, broadcast to all addresses	
<i>DCS210 Option Switch Tables</i>		

* See special instructions in *Section 8.1* for setting OpSw 36,37,39, and 40.

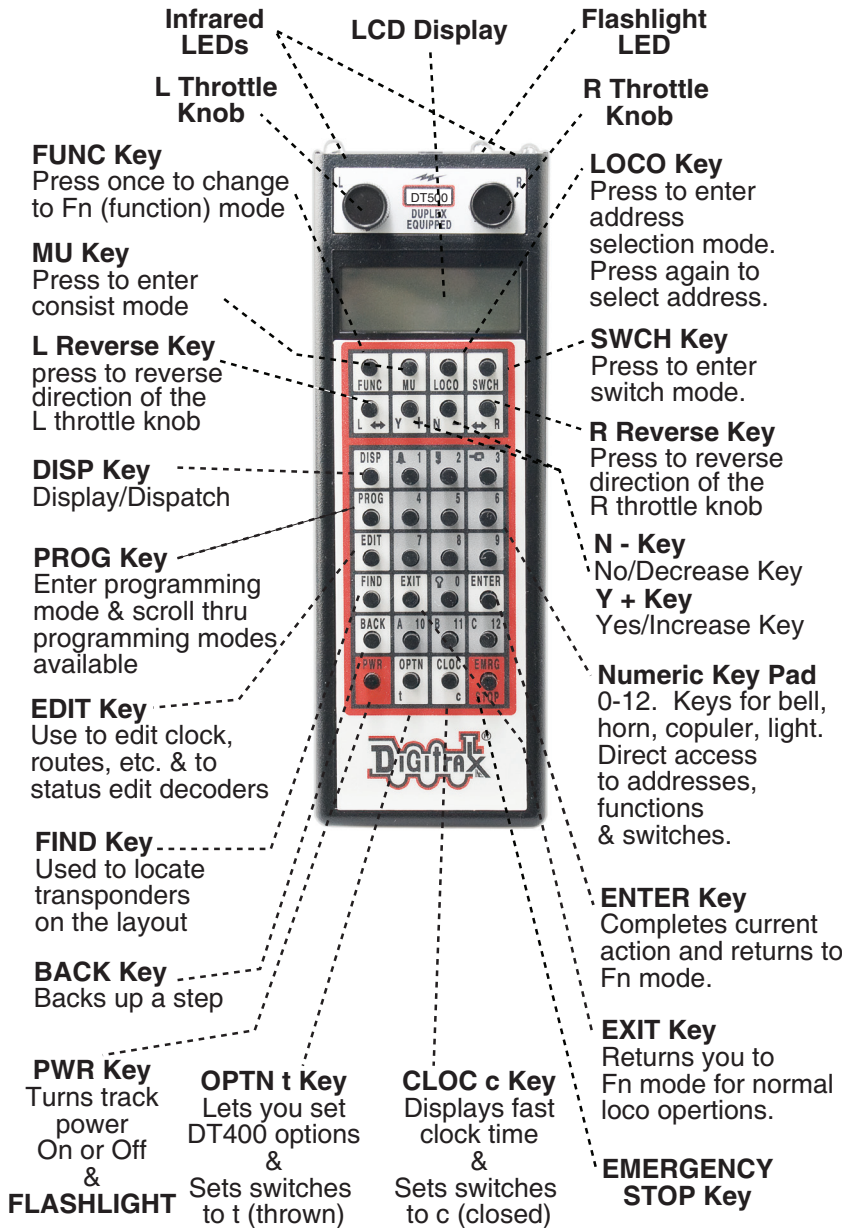

Remember, the EXIT Key will take you back to the Fn Mode for Normal Loco Operations.

DT500 Throttle Controls

9.0 DT500 Series Throttle Control Panel

9.1 General Information

The DT500 series throttles are full function hand held throttles that include 2 independent throttles and a common keypad to control, up to 29 functions (F0-F28), turnouts and programming.

9.2 L (Left) and R (Right) Throttle Knobs

Throughout this manual we refer to the throttle knob on the left side as the **L** Throttle and the throttle knob on the right side as the **R** Throttle. This corresponds to the **L** and **R** that appear on the throttle.

The throttle knobs on the DT500 use “encoders.” They give very smooth, fine speed control. In 128 speed step mode it takes four complete rotations of the knob to go from stop to full speed. When you select a locomotive that is already moving on either throttle knob, that throttle will continue to run the locomotive at the same speed and in the same direction in which it was traveling before being selected to the throttle.

As you turn the DT500 throttle knobs you will feel a mechanical detent (and hear a beep if your throttle is set up for beeps and clicks). Each time you move the knob, the system processes information. In some cases, the LCD display will not change each time you feel the detent. In the case of increasing and decreasing loco speed, this is because each detent does not equal an increase of 1% speed. If your DT500 is set up for ballistic tracking, the speed with which you move the encoder will affect how the display changes.

You can customize the tracking characteristics of these knobs for either straight line (normal) tracking or ballistic tracking. With straight line tracking each movement of the knob causes a fixed rate of change. With ballistic tracking, the faster you increase or decrease the throttle knob, the faster the data changes in the throttle. Your DT500 was shipped with ballistic tracking as the factory default setting. To change this setting see Section 15.0 (option: NoBlstic).

The throttle knobs on the DT500 can also be used to access the recall stack and select a locomotive to run on a throttle or to reverse the direction of the locomotive currently selected on that throttle.

When dialing up numbers with the throttle knobs, the **R** Throttle knob changes 1s and 10s and the **L** Throttle knob changes 100s and 1000s. This makes the throttle knobs easy to use when dialing up four digit addresses.

If you prefer larger throttle knobs, simply remove the 1/2” knobs that come standard with the DT500 by pulling gently away from the throttle and replacing them with larger knobs (up to 1.25”).

9.3 Liquid Crystal Display (LCD)

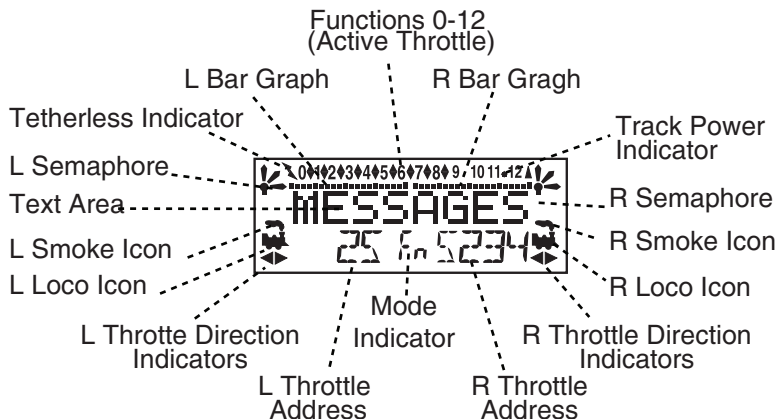

DT500 LCD

9.3.1 Loco Icon

The L and R Loco Icons  are used to indicate whether an address is available for selection. A blinking loco icon means that the address is available for selection and a steady loco icon means that the loco address is currently selected or in use by another throttle.

9.3.2 Direction Indicators

The direction indicators  are located in the LCD Display of the DT500 directly below the Loco Icon. There are separate indicators for the L (left) and R (right) throttles. If the arrow points to the front of the loco, the throttle is in the forward direction. If the arrow points to the back of the loco, then the throttle is in the reverse direction. If there is not a locomotive selected on a throttle the loco icon will not appear.

 = Forward Direction  = Reverse Direction

Note: These direction indicators are for decoder equipped locos only. They will indicate direction based on the normal direction of travel that you set up for your decoder equipped loco. If you are using an analog loco (without a decoder), the direction indicator may or may not match the physical direction of the analog loco.

9.3.3 Smoke Icon

The Smoke Icon is located just above the Loco Icon. Both the **L** and **R** Throttle have a smoke icon. If a loco is selected on either throttle, the Loco icon will appear beside the address of that loco. If nothing is selected, there will be no Loco icon and the address area will show SEL. The blinking smoke icon indicates which throttle is currently active (having its function states dis-

played in the top line of the LCD). Since both throttles share the keypad, only one at a time can use the keypad and function controls. The active throttle has access to the function controls and the status of the functions for the active throttle are displayed in the top line of the LCD. To make either throttle the active throttle simply click it once or turn the Throttle knob a little.

No Loco Icon = nothing selected on this side of the throttle



Loco with steady smoke = Keypad and function display not active for locomotive address selected on this throttle.



Loco with flashing smoke = Keypad and function display active for the locomotive address selected on this throttle.

9.3.4 Mode Indicator

The mode indicator, located at the bottom center of the LCD, shows the DT500's current mode of operations.

The DT500 automatically defaults to the Fn mode and returns to this mode when ever the **EXIT** key is pressed. **The Mode indicator usually shows what the numeric keys are associated with.** For example, in Fn mode, any entry on the numeric keypad will affect functions. In Sw mode, keypad entries will change turnouts and in Lo mode, entries on the keypad will enter loco address numbers, etc.

The following table provides a list of the Mode indication displayed, the mode name and the use of the mode by the DT500.

9.3.5 Text Area

The Text Area of the LCD consists of the eight characters in the middle line of the display. This is where information like locomotive speed, decoder status, turnout position, fast clock, text prompts, messages and programming data are displayed.

9.3.6 L (Left) and R (Right) Throttle Display

The decoder address selected on the **L** Throttle is displayed on the bottom line of the LCD to the left of the Mode Indicator. The decoder address selected on the **R** Throttle is displayed to the right of the Mode Indicator. The address can show as either the 2-digit or the 4-digit decoder address. If no address is selected the display will show "SEL." If a 2-digit address is selected (00-127), the display will show two or three digits. If a 4-digit address is selected (0128-9983), the display will show all four digits including the leading zero.

Throttle in normal operations mode indicated by Fn.
 In Function (Fn) Mode
 Throttle knobs control Loco's Speed & Direction.
 Keypad entries control functions. Track Power Indicator ON

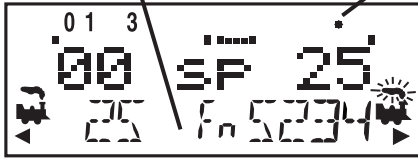

2 digit address 25
 Selected on the
 L Throttle
 Running at 0% speed
 In reverse.

4 Digit address 5234
 Selected on the
 R Throttle
 Running at 25% speed
 In the forward direction
 Functions 0, 1, & 3 on.

DT500 Mode Indicator Display

9.3.7 L and R Bar Graph

Each throttle has a bar graph located above the text area of the LCD. Each of these indicates the speed setting of the **L** and **R** Throttles graphically from a single dot (0% throttle) to 20 dots (full throttle). This is useful when the text area is showing information other than speed.

Bar Graph showing 50% speed on R Throttle

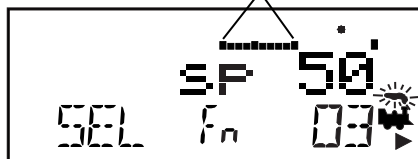

Bar Graph showing full speed on R Throttle

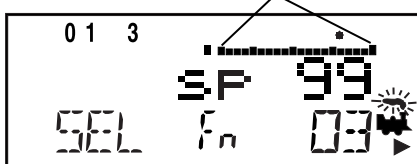

Display	Mode	Used For
Fn	Function	Normal locomotive operation functions available on the keypad
Lo	Loco Selection	Locomotive Address Selection Mode
Mu	MU	Multiple unit (consist) operation set up and break up
Sw	Switch	Accessory decoder control (turnouts, etc.) or option switch control
PW	Power	Turn track power on and off
SE	Status Edit	Change locomotive speed steps to 14, 28, or 128 as needed
PG	Programming	Paged
PH	Programming	Physical Register
Pd	Programming	Direct - Digitrax preferred method
Po	Programming	Operations Mode (Ops Mode) programming on the mainline.
RE	Recall	Recall one of the last 4, 8, or 16 locomotive addresses used
Fd	Find	Find command issued for active loco, results displayed in text area.
Ec	Edit clock	Edit the time shown on the fast clock
EF	Edit clock rate	Edit the fast clock rate
EA	Edit alarm	Edit the alarm time set for the throttle
Er	Edit routes	Edit routes-shows when your system is running with a DCS100 with routes enabled
E1	Change LocoNet ID	Change LocoNet ID for Infrared or Radio Operation
E?	Other edit modes	Show when your system is running with a LocoNet component that is enabled for additional functionality such as signaling.
Q?	Query	Shows statistics for compatible devices 0-9
In	Input	Shows changes in detection sections

9.3.8 Function Display

Whether functions 0-12 are on or off for the currently active loco address is displayed on the top line of the LCD. In other words, the functions for the active throttle (the one with blinking smoke) are displayed. To view the function status of either throttle, simply press the throttle knob to display the active functions for that throttle.

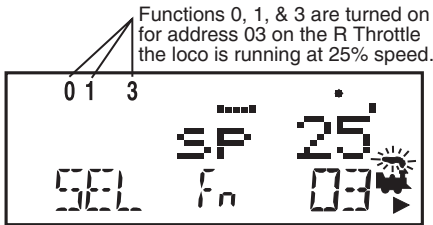

9.3.9 Track Power Indicator

This very small star shaped dot  (shown larger than life) located in the top line of the LCD on the right side indicates the status of the track power.

No indicator (tOFF flashing in right throttle address) = System track power is OFF (Press **PWR** key followed by **N / -** key)

Indicator On Steady = System track power is ON (Press **PWR** key followed by **Y / +** key)

Blinking Indicator (Idle flashing in right throttle address) = System is in "Idle" and track power is ON (Press **PWR** key followed by **Y / +** key and **Y / +** key again)

9.3.10 Tetherless Indicator

 The tetherless indicator shows when your throttle is using either infrared or radio communications.

9.3.11 L and R Semaphores-Cab Signaling

 The L and R Semaphores are used when cab signaling is implemented on the layout. More information about signaling and detection will be available on our web site, www.digitrax.com as these products become available. Information on how to activate these indicators is in the manuals for our detection and signaling products. Information is also available from other LocoNet Certified developers when they have implemented these features in their products.

The L and R Semaphores will display the following:

 = Clear

 = Approach

 = Stop

9.4 DT500 Keypad

9.4.1 FUNC Key



The **FUNC** key is used to enter function control mode. Function control mode is the default mode for normal locomotive operation with the DT500. Press this key during any throttle task to return to normal loco operation mode with function controls active on the numeric keypad.

9.4.2 MU Key



The **MU** key is used to enter consist set up mode. Once the MU Key is pressed, you will be prompted by the throttle to use the Y+ Or N- Keys to add locos to or remove locos from consists.

9.4.3 LOCO Key



The **LOCO** key is used for selecting loco addresses on to the throttles so that the address is controlled by the throttle. Sometimes people call this “assigning locos to throttles.”

9.4.4 SWCH Key



The **SWCH** key is used for entering switch control mode. Once this key is pressed, you will be prompted to select a switch address and issue a thrown or closed command. Switch control mode is used in normal operation for operating turnout machines and in set up mode for setting up option switches in the throttle and command station.

9.4.5 L and R Reverse Keys

The L and R Reverse Keys change the direction of travel of the loco on the related throttle when the throttle is in Fn (Normal Operation) Mode.



The **REVERSE / R** key changes direction of the address on the “**R**” or Right Throttle. The **REVERSE / R** key pressed after the **PWR** key will enter Input Mode. See Section 14.6 for more info.



The **L / REVERSE** key changes direction of the address on the “**L**” or Left Throttle. The **L / REVERSE** key pressed after the **PWR** key will activate Slot Zero when the throttle is plugged in. See section 10.11 for more details.

9.4.6 Y / + and N / - Keys



The **Y / +** key and



N / - key are used:

- to turn track power on and off,
- to increase or decrease loco speed,
- to link and unlink locos during MU'ing,
- to accomplish tasks using system editors,
- to select devices in Query Mode.

These keys can be set up to act in two different ways: See Section 15.0 (NoBlstic) for information on changing this setting on your DT500.

Repeating (also called typematic) so that if you hold a key down it will continue to increase or decrease step by step until you release the key. This option is active when your throttle is set up for ballistic tracking. Your DT500 was shipped from the factory with this feature enabled.

Single Press so that you will must press the key each time you want to increase or decrease. This option is active when your throttle is set up for straight line tracking.

9.4.7 DISP Key



The **DISP** key is used for displaying programming information and dispatching loco addresses. The **DISP** key pressed after the **PWR** key will enter and refresh query mode. See section 14.5 for more details.

9.4.8 PROG Key



The **PROG** key is used to enter programming mode and to toggle among the programming modes available for use.

9.4.9 EDIT Key



The **EDIT** key is used to enter the Edit Mode for editing the fast clock, routes, signaling, etc. It is also used to status edit decoders while in locomotive address selection mode.

9.4.10 FIND Key



The **FIND** key is used in conjunction with a layout instrumented for Digitrax Transponding and locos or cars equipped with transponders to find the location of those pieces of rolling stock on the layout. The **FIND** key is also used when remotely joining a duplex radio group, See section 13.4.1.

9.4.11 BACK Key



The **BACK** key is used to go back one step and with the **PWR** key to turn off the throttle. See section 4.1.

9.4.12 PWR Key



The **PWR** key is used to turn track power and throttle power off and on. Additionally, it can be used to control the flashlight, activate Slot Dispatch (SlotDisp), enter Statistics mode, and Input mode.

Press and Hold the **PWR** key to turn throttle power ON when it is unplugged.

Press and Hold the **PWR** key to turn throttle power OFF when it is unplugged and Idle.

Press **PWR** to enter power mode for turning layout power on and off. Once you press this key, you will be prompted to use the **Y / +** key to turn track power on or the **N / -** key to turn track power off.

The **PWR** key will activate the flashlight as long as it is held down.

Press **PWR** key followed by the **BACK** key to turn off the throttle power when it is unplugged and active.

Press the **PWR** key followed by the **L / REVERSE** key while the throttle is plugged in to activate Slot Zero. See section 10.11

Press the **PWR** key followed by the **REVERSE / R** key to enter Input Mode. See Section 14.6.

Press the **PWR** key followed by **DISP** key to enter query mode. See Section 14.5.

9.4.13 OPTN / t Key



The **OPTN / t** key is used to enter the Option Mode to set throttle and system options. It is also used to issue **t** (thrown) commands when the throttle in Switch mode.

In the case of turnout control:



t=thrown, turnout is set for the diverging route through the curved leg.

9.4.14 CLOC / c Key



The **CLOC / c** key is used to toggle between displaying and not displaying the current fast clock time. It is also used to issue **c** (closed) commands when the throttle in Switch mode.

In the case of turnout control:



c=closed, turnout is set for the main line with routing through the straight leg of the turnout.

9.4.15 EXIT Key



The **EXIT** key is used to exit the current throttle task without making changes. Pressing this key will usually return the DT500 to Fn mode for regular locomotive operation. Pressing and holding the **EXIT** key is the easiest way to get the throttle to exit power save mode.

9.4.16 ENTER Key



The **ENTER** key is used to complete the current throttle task and return to Fn mode for normal operations.

9.4.17 EMRG STOP Key



Your DT500 comes from the factory set for “Local” Stop. When you press the **EMRG STOP** key, the loco address that is active on your display (the one with the blinking smoke) will stop. When you press the **EMRG STOP** key again, the loco address on the other throttle of your DT500 will stop.

9.5 Full Numeric Keypad

The numeric keys on the keypad are usually related to the throttle mode shown in the LCD’s mode indicator area. For example, when the mode is Fn, the numeric keys are used for function control. When the mode is Lo, the numeric keys are used to enter loco addresses. When the mode is Sw, the numeric keys are used to enter switch addresses.

The **0-12** keys allow direct entry of loco and switch addresses as well as Configuration variables (CVs) values during selection and programming. These keys also give direct access to functions 0-12 during normal operation of locos. Special number keys:



The **LAMP / 0** key is most often used to turn on and off the loco’s head lights. It can also be used for other functions as desired.





The **BELL / 1** key is most often used to turn on and off the bell sound in locos equipped with sound decoders.



The **HORN / 2** key is most often used to turn on and off the horn sound in locos equipped with sound decoders. This function key is a momentary key that will activate the sound as long as the key is held down. This key also pressure sensitive to allow for the use of sound decoders that incorporate a “playable whistle.”



The **COUPLER / 3** key is most often used to activate couplers. It can be used for any function.    The **A / 10**, **B / 11** and **C / 12** keys

make it easy to use functions 10-12 and give more flexibility for future features by providing A, B and C as possibilities.

9.6 Infrared Emitters

Your DT500 has two infrared LEDs in the cable end of the throttle. These emitters send infrared signals that can be used by LocoNet compatible Infrared receivers to give you tetherless operation. See Section 13.2 for infrared operation information.

10.0 How to Select and Run Trains

10.1 DT500 Powering ON and OFF

DT500 throttles have the capability of being powered OFF and ON in order to save battery power while unplugged without having to remove the battery. A throttle will automatically power ON when it is plugged into an active LocoNet. While plugged into a powered LocoNet the DT500 cannot be powered OFF.

To power on your throttle:

1. After Installing a known good battery into your throttle Press and hold the **PWR** key until the display comes on.
2. The DT500 will briefly see the DT500 splash screen:

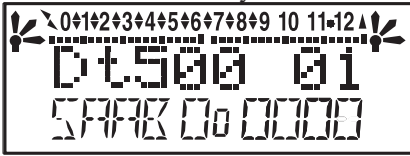

This screen shows the throttle type: DT500 or DT500D and software version number (xx). It is displayed for a few seconds each time you power your DT500.

3. The DT500D will then momentarily display the Duplex Group name and radio Channel.
4. Next you will see the power indicator screen.

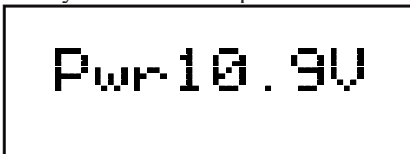

This screen indicates the power available to the throttle. When you are plugged in to LocoNet, this value should be between 9 and 15 volts for proper operation. When you insert a battery or unplug from LocoNet, the value displayed will be the battery power available. When this number is less than 6.2 volts it's time replace your battery. See Section 3.0 for more information about installing/replacing the batteries in your DT500.

5. If you are using a DT500 throttle, the throttle will now go Idle until it is plugged into an active LocoNet. A DT500D throttle will attempt to log onto the last network it was joined to. If it cannot find the network, it will go idle. It will need to be plugged into an active LocoNet or manually joined to a network as outlined in section 13.4.
6. Once you are connected to an active LocoNet you will see a screen similar to the following.

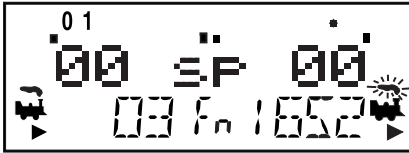

This screen displays current addresses selected on the L and R throttles along with their current speed and direction. The functions that are turned ON for the active throttle (the one with the blinking smoke icon) are displayed across the top of the display.

To power off your throttle:

If your throttle is unplugged and in an Idle state:

1. Press and hold the **PWR** key until the screen displays “Pwr Off”
2. The screen will then briefly display the power indicator screen, then power off completely.

If your throttle is unplugged and operating in IR/Duplex Radio Mode:

1. If the throttle is in power save mode wake the throttle by pressing and holding the **EXIT** key until the throttle screen displays
2. Press the **PWR** Key then press the **BACK** key.
3. The screen will display “Pwr Off”, then briefly display the power indicator screen, before powering off completely.

10.2 Turn track power on and off

The TRACK POWER indicator on your DT500 display shows the track power status. There is also a TRACK STATUS LED on your Command Station. If the TRACK POWER indicator is lit then track power is on. To turn the track power on or off:

1. Press the **PWR** key on the DT500. You will see a screen similar to the one below. You will now be able to toggle the track power on/off:

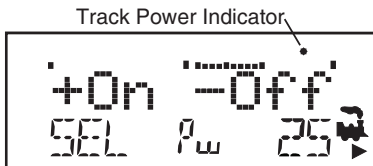

2. Press the **N / -** key to toggle the track power off. The TRACK POWER Indicator on your DT500 and on your Command Station will go off. “tOFF” will flash in the right throttle address area.
3. Press the **Y / +** key to toggle the track power on. The TRACK POWER Indicator on your DT500 display and on your Command Station will come on solid.
4. Press the **PWR** key again to return the DT500 to the operating mode.

10.3 Select and Run An Analog Loco on Address “00”

1. Place an analog locomotive (one without a decoder) on your layout. While the analog loco is sitting still, you will hear the characteristic “singing” caused by the DCC track signal when it is applied to analog locomotives. Once the analog loco is moving, this sound will change and be less noticeable. (Digitrax recommends that analog locos not be left sitting on DCC powered track for long periods of time when they are not running.)
2. Check the Track Power Indicator is steady on your DT500’s display and the TRACK STATUS LED on Command Station is lit .
3. Activate the DT500’s **R** Throttle knob by turning it a 1/4 turn in either direction or by pressing the **R** Throttle knob once if there is a current loco address and double click if SEL appears in the **R** address. If there is a loco address, the **R** Loco Smoke will start flashing. If no loco has been previously selected on this throttle it will flash “SEL”.
4. Press the **LOCO** key then 00 on the keyboard. You can also use the **R** throttle knob to dial in the number. You will see a display similar to this:

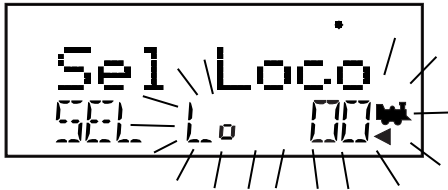

5. Press the **LOCO** key again to select address 00 on the throttle. You can also press the **R** Throttle knob once to select the loco address and return to Fn mode for normal operation.

Note: **EXIT** key can be used to return to Fn mode for normal loco operation.

6. Turn the **R** Throttle knob clockwise slowly to increase the speed of the analog locomotive. As the speed increases, the locomotive on the track will begin to move. Your command station’s TRACK STATUS indicator should change color as you change the speed setting.
7. Press the **REVERSE / R** key on the right side of the DT500 or double click the **R** Throttle knob to reverse the direction of the analog loco. The **R** Direction Indicator will toggle between the left and right arrows. In the case of the analog loco, the indicator only indicates a change in track polarity and the physical direction of the analog locomotive-NOT THE ANALOG LOCO’S ACTUAL FORWARD OR REVERSE DIRECTION OF TRAVEL.

Note: To double click the throttle knob, quickly press down on the throttle knob twice within about 1/2 second. You will hear a click each time you press down on the throttle knob.

10.4 Select and Run A Decoder Equipped Loco

Each decoder has an address. To select a decoder equipped locomotive and run it on either throttle, you must know its address. Digitrax decoders are set up at the factory with the “default” address 03. This means that when you take a Digitrax decoder out of the package and install it in your loco, you can select address 03 on your throttle and run the decoder. The first Configuration Variable (CV) programmed by most users is the decoder’s address since it is not very useful to have all of your locos run on address “03.”

If you do not know the address of the decoder equipped locomotive you want to run, you can simply program the decoder’s address and select it to run using the new, known address. With some command stations, it is possible to read back the decoder’s address. *See Section 16.1 and your Digitrax Decoder Users Manual for a complete discussion of decoder addressing.*

1. Place a decoder equipped locomotive (one with a decoder installed) on your layout.
2. Check the Track Status indicator is steady on your DT500’s display and the Command Station TRACK STATUS LED is lit, so track power is turned on.
3. Activate the DT500’s **L** Throttle knob by turning it a 1/4 turn in either direction or by pressing the **L** Throttle knob once if there is a current loco address and double click if SEL appears in the **L** address. If there is a loco address, the **L** Loco Smoke will start flashing. If no loco has been previously selected on this throttle it will flash “SEL”.
4. Press the **LOCO** key. The left side of the display will begin flashing. You will see a display similar to this:

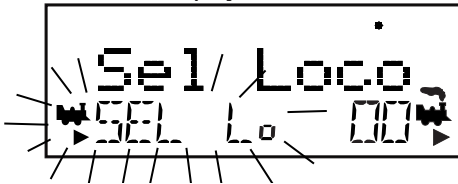

5. Use the numeric keypad to enter 03 or use the **R** Throttle knob to select Address “03” in the left side of the display. (The **R** Throttle knob changes 1s and 10s, the **L** Throttle knob changes 100s and 1000s.)

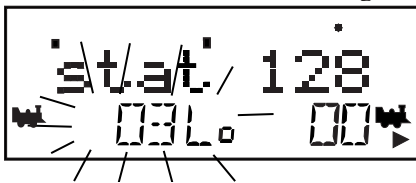

6. Press the **LOCO** key again to select address 03. Press the **L** Throttle knob once to select the loco address and return to Fn mode for normal operation.

The illustration below shows the display after address “00” is selected on the **R** Throttle and address “03” is selected on the **L** Throttle, We see the Track Power On Indicator in the top line, the speed bar graphs at 0 speed and the text area also at 0 speed for both throttles.

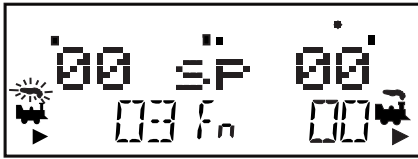

7. Turn the **L** Throttle knob clockwise slowly to increase the speed of the decoder equipped locomotive. As the value in the left display increases, the decoder equipped locomotive on the track will begin to move.
8. Press the **L / REVERSE** key on the left side of the DT500 or double click the **L** Throttle knob to reverse the direction of the decoder equipped loco. The **L** Direction Indicator will toggle between the left and right arrows. In the case of the DCC loco, the arrow indicates locomotive direction (forward or reverse), not the direction on the track.
9. Use the **R** Throttle knob and **REVERSE / R** key to control the analog loco and the **L** Throttle knob and **L / REVERSE** key to control the decoder equipped loco. You can control both at the same time.

Throttle in normal operations mode indicated by Fn.
 In Function (Fn) Mode
 Throttle knobs control Loco's Speed & Direction
 Keypad entries control functions

Track Power Indicator ON

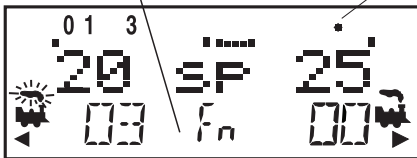

2 digit address 03
 Selected on the
 L Throttle
 Running at 20% speed
 In reverse
 Function 0, 1, & 3 on.

An analog loco address 00
 Selected on the
 R Throttle
 Running at 25% speed
 The direction arrow below
 the Loco Icon **does not**
 indicate actual direction
 for Analog locos.

Notice as you use each throttle knob or direction key that the loco with the “blinking smoke” will change to that side of the throttle. The side with the “blinking smoke” indicator is the active throttle. To control the headlight or other functions, the locomotive must be on the active throttle.

10.5 Locomotive Speed Control

1. Select the loco address you want to control on either the **L** or **R** Throttle.
2. To increase the speed of the loco, either turn the Throttle knob clockwise or press the **Y / +** key. Holding down the **Y / +** key will continue increasing the speed of the loco.
3. To decrease the speed of a loco, either turn the Throttle knob counter-clockwise or press the **N / -** key. Holding down the **N / -** key will continue decreasing the speed of the loco.

The % of full speed will be displayed in the text line of the display on the **L** or **R** side, depending on which throttle is controlling the loco. The % of full speed will also be displayed on the bar graph above the text area in the display.

If a loco address is part of a consist and is not the “TOP” (or controlling locomotive) and you try to change its speed the LCD screen will show “cn” in the text area where % speed would normally appear. The “cn” lets you know that the loco you have selected is part of a consist and that you cannot change the speed or direction of this loco independently of the consist.

10.6 Releasing An Address From A Throttle

When you are finished running a locomotive address, release it from your throttle so that it is available for other throttles to select and run.

Infrared Throttles must be plugged in to LocoNet to release an address from your throttle. Duplex Radio Throttles do not need to be plugged in to release an address. You can disable this safety feature by setting your DT500's Options to allow tetherless release (See Section 15.1 (IRRelease) for instructions).

1. Use the throttle to make the locomotive's speed zero (this step is optional but strongly recommended as the loco will continue to move if speed is not reduced to zero).
2. While the loco's address and speed information is displayed, press the **LOCO** key to go into select mode. This will release the address from your throttle immediately.
3. The address will begin to blink in the display. Press the **DISP** key to dispatch the address on the throttle and the address will be released to the system and marked as a dispatched address. See Dispatching below. Pressing the **EXIT** key releases the address from both the throttle and the locomotive stack in the system. The display on your DT500 will show SEL for the throttle.
4. If you press the **LOCO** key again, the throttle will begin flashing the address you just released. You can re-select that address by pressing the **LOCO** key or you can use the throttle knobs or key pad to browse to a new address and select it instead.

10.7 Dispatching addresses or consists

Dispatching is a special feature incorporated in the LocoNet language to meet the needs of operators that wish to enforce a strict discipline in how operators gain access to locomotives during an operating session. Dispatching also lets you run consists with basic throttles that can't set up their own consists and run four digit addresses on basic throttles that only have two digit capability. It lets you have newcomers run trains on the layout without giving them access to the entire operation.

When you dispatch a locomotive address or consist to your LocoNet system, you make it available to be acquired by another throttle. Only one address at a time can be marked as a dispatched address in the system.

To dispatch a locomotive address using a the DT500

1. Press the **LOCO** key to enter address selection, browse to the address you want to dispatch.
2. Press the **DISP** key to dispatch it to your LocoNet system, that's all there is to it!

The dispatched address can be a single locomotive address, either two digit or four digit, or a consist that was set up by the DT500. The TOP locomotive in a consist or MU can be dispatched to transfer control of the entire consist to another throttle.

NOTE: DT500 throttles operating in IR mode must be plugged in to LocoNet to dispatch loco addresses. DT500D does not need to be plugged in to dispatch.

10.8 Recall a Loco

Your DT500 stores the last 4, 8, or 16 unique loco addresses used by the throttle in a recall stack. Your DT500 defaults to a 4 address recall stack. See Customizing Your Throttle, Section 15.1(Recall#) for information on how to set the recall stack depth.

For example if you have your DT500 set up for an 8 deep recall stack and the last 8 addresses you selected were: 00, 1987, 52, 0678, 03, 8819, 25, and 2500, these addresses will be in the recall stack. If you have selected any of these addresses more than once, it will not be stored twice, only the addresses not already stored will be added to the stack. The recall stack is not stored in numeric order. This makes it convenient to select locos that you have used previously without having to dial up the address.

To Recall the last 4, 8, or 16 addresses on the R Throttle

1. Press and hold the **R** Throttle knob. The word "Recall" will appear in the text line in the middle of the display.
2. When "Recall" appears in the display, release the knob. "RE" will appear in the mode indicator in the center of the bottom line on the display. The right

side address display will begin to flash prompting you to select a locomotive.

3. Turn the **R** Throttle knob to browse through the last 4, 8, or 16 addresses selected in the system. Whether you browse 4, 8 or 16 addresses depends on how you set up your throttle's options. As you browse through the addresses, the throttle will display their current speed on the bar graph and their status in the text line of the display. Addresses are displayed in the order they were used by the throttle (not in numeric order).
4. Press and release the **R** Throttle knob or the **LOCO** key to select the desired loco address. Once the locomotive is selected the R Throttle knob will be able to control the speed control and direction of that locomotive.

Follow the same steps for recall on the **L** Throttle.

10.9 Stealing: Forcing An Address Selection

If you try to select a loco address that is already selected on another throttle the DT500 will display "Steal?=Y" in the text area. This is a safety interlock to prevent operators from taking control of locos that are already selected on other throttles. Occasionally it is necessary to override this interlock to gain control of a loco that is "lost" for whatever reason. This override is called stealing. Stealing will behave differently depending on if you are using Standard or Expanded Slots.

To steal an address with the DT500:

1. Press the **LOCO** key to enter selection mode.
2. Enter the address of the loco you want to steal and press the **LOCO** key again.
3. The DT500 will display "Steal?=Y" in the text area if the loco can be stolen.
4. Press **Y/+** key if you want to steal.
5. Press **N/ -** (or any other key) if you do not want to steal.

If you are using a standard slots once a throttle has "stolen" a loco address, the slot following mode becomes active. Both throttles will update speed and direction information for the loco address. This can result in seemingly strange locomotive behavior especially if one throttle is trying to stop the loco and the other is trying to speed it up at the same time. This occurs if legacy throttles are used with your DCS210 or if the DT500 throttle has expanded slots disabled by either having IR turned on or XP slots turned off. See section 15.1 for more details.

The DCS210 has built in safeguards to keep the same locomotive from being selected on two DT500 throttles at the same time and causing unexpected operations. See StealZap below.

When you have gained control of the stolen loco and are finished running it,

release it from your throttle by setting the loco's speed to 0 and pressing the **LOCO** key followed by the **DISP** or **EXIT** Key.

10.9.1 StealZap

When using a DT500 throttle with an Advanced Command Station featuring expanded slots, each throttle ID is associated with the Loco Addresses it has selected. With a when you select a Loco that is selected on another advanced throttle (DT500 R2 or later) the second throttle will take ownership of the Loco and it will be deselected from the first throttle. The first throttle will display "StealZap" meaning it has deselected the loco because it has been stolen by another throttle. You always have the option to steal the loco back by selecting it again.

This feature only works when each advanced throttle has a unique throttle ID and they are operating in expanded slots. If throttles have the same ID it is possible to select the same address and two throttles can have control of a locomotive.

When using legacy throttles prior to the DT500 R2 stealing a locomotive will still result in the loco being selected and taking commands from two or more throttles.

10.9.2 Slot Following

When using standard slots a DT500 will detect that a loco address that is in-use on one of its throttles is being changed by another throttle or computer, it will cause the DT500 to "click" every time it sees a remote throttle change its locomotive settings. If that locomotive is in the active throttle, its speed display will also show the changes. This is called slot following. This allows two DT throttles to run a single locomotive address with both throttles being able to send commands to the loco. Both throttles will show the current speed and direction of the locomotive in their displays.

Slot following can also be useful for training new operators. The supervisor can "steal" an address that is selected on a trainee's throttle and be able to closely supervise that locomotive's control. The supervisor can gain instant override control without having to "grab" the trainee's throttle. This lets you have unskilled visitors run your layout without too much anxiety for either party. You must have expanded slots turned off in your DT500 to do this, see section 15.1.

Slot following also allows a computer on LocoNet to run CTC and routing control programs with automated control. The computer can control speed and stop engines automatically while letting the engineer with the throttle in his hand know what is happening.

Note: Slot following does not update continuously when DT500D is used in Duplex Power Save Mode (as shipped from the factory). For continuous slot following updates, change Option DxRxLPwr to OFF. This will significantly increase battery consumption when slot following is in use.

10.10 “slot=max” Message

If the text area of the DT500 shows the message slot=max during the selection process this means that the Command Station reached the limit of locomotive addresses that it can manage at one time. If you want to select additional addresses, you will need to release one or more loco addresses to continue the selection process. (See Section 10.6 for more information.)

10.11 SlotZero

When Slot Zero is activated all locos selected in the system will be set to 0 speed and all functions will be turned off. No consists will be lost or broken up and all locos will remain in the system. This is an easy way to reset your layout before shutting down. The Loco Reset button on your DCS210 may also be configured to activate this feature. See section 8.2

To activate Slot Zero using a DT500:

1. Plug in your DT500 throttle, you must be plugged in, even with a duplex radio throttle to activate Slot Zero.
2. Press the **PWR** key followed by the **L / REVERSE** key
3. The throttle will display “SlotZero” and the Net light will flash on the command station.
4. This operation can take a few seconds to complete, when done the throttle will return to the default screen.
5. After Slot Zero is complete wait 30 seconds and set the Command Station to Sleep mode.
6. To resume operations set the DCS210 back to Run Mode.

Note: This operation should be performed when no other active throttles are attached to LocoNet. If an active throttle refreshes a locos speed the loco will resume motion even after the Slot Zero command is sent. It’s recommended to sleep the system after performing this operation so when the system wakes all throttles are forced to log back on with updated 0 speeds.

To activate SlotZero using the Loco Reset button:

Make sure you have properly configured your DCS210 OpSw to perform this function see section 8.2

1. Press the Loco Reset button, the DCS210 will beep 3 times.
2. The net light will blink steadily as the Slots are Zeroed.
3. Once the Net Light Stops blinking, wait 30 seconds then set the DCS210 to Sleep Mode.
4. To resume operations set the DCS210 back to Run Mode.

11.0 Stop

11.1 Setting A Loco to Zero Speed

Turn the Throttle Knob that the loco address is selected on counterclockwise until the speed display shows 00 and the loco stops moving. This lets you slow down your loco and stop it prototypically.

If you have set up deceleration for the loco and you move the throttle knob to 0% speed, your loco will slow down and come to a stop at the programmed deceleration CV value. We strongly recommend that you run your locos with the factory default of no deceleration until you are familiar with your system.

If the deceleration CV value you set for a particular loco is very large, this can make it look like the loco is not stopping on command because the deceleration CV value is causing the loco to take a long time to come to a stop.

11.2 Emergency Stop

DT500s have two ways of stopping locos quickly. When you use emergency stop, the deceleration rate programmed into the decoder will not have an effect and the stop will be immediate.

11.2.1 Local Stop-Factory Default

To stop only the locos in the DT500 display.

1. Press the **EMRG STOP** key to stop the loco that is active in the DT500's display. To resume operation, use the throttle knob associated with that address to increase the loco's speed.
2. Press the **EMRG STOP** key again to stop the loco that is associated with the other throttle on the DT500. To resume operation, each operator must use their throttle to set their loco's speeds back to the desired speed.

11.2.2 Track Power Off Stop

To stop everything on the layout.

1. Press the **PWR** key followed by the **N/-** key while the track power is on. This will turn track power off and will cause all locos to stop.
2. Press the **PWR** key followed by **Y/+** key again and the locomotives will start running again at the same speed they were running prior to STOP mode. To exit **PWR** mode, press the **PWR** key or the **EXIT** Key.

12.0 Controlling Functions

The DT500 Throttle will control up to 29 functions in walkaround and radio modes. When operating in IR Mode the DT500 throttles will control up to 9 functions (F0-F8). The numeric keypad is always active in the normal Fn operation mode. The functions that are currently on for the active loco will be displayed on the top line of the DT500 display. The following figure shows an example of how the display looks when functions 0 and 1 are turned on for loco 1652 on the R Throttle.

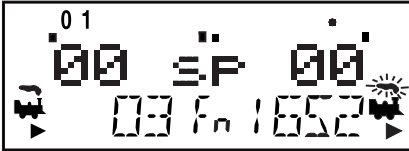

12.1 Controlling Functions F0-F12

1. Determine which throttle you want to control functions on and make it the active throttle by single clicking the Throttle knob or by turning the throttle knob a couple of clicks.
2. If the Mode indicator in the center of the bottom line of the display (between the loco addresses) does not show Fn, press the **FUNC** key once to enter the function mode for the active throttle.
3. The DT500's numeric keypad is always active in function mode during normal loco operations. When the mode indicator on your DT500 shows Fn, simply press any number on the keypad to activate or deactivate any function from 1 to 12. The functions that are on for the active loco will be displayed on the top line of the display.

12.1.1 Function 0 (F0)

Press the **LAMP / 0** key to toggle F0 between on and off. Each time the **LAMP / 0** key is pressed while in function mode, F0 will change from off to on or vice-versa. The top line of the display will display a 0 when the F0 is on and will be blank when F0 is off. F0 is most often used for reversing head lights but can be set up for other functions as well.

12.1.2 Function 2 (F2)

Press the **HORN / 2** key on the numeric keypad. F2 is labeled with a whistle icon to remind you that this is the preferred function for whistle or horn operation.

F2 is a special non-latching function. This means that F2 can be used to control a whistle or horn sound from the decoder. It will only sound when F2 is being held down. This lets you vary the length of time that the whistle blows, just like the prototype.

12.1.3 Functions 1, 3, 4, 5, 6, 7, 8, 9, 10, 11, & 12

Press the button on the numeric keypad that corresponds with the function number you want turn on/off. The top line of the display will display the numbers of the functions that are on for the active loco address.

F1 is labeled with a bell icon to remind you that this is the preferred function for bell operation and F3 is labeled with a coupler icon to remind you that its preferred function is coupler operation.

Note: DT500 may process functions slightly differently depending on command station capabilities.

12.2 Controlling Expanded Functions F13-F19

The DT500 series throttles feature an expanded feature set and can address additional functions F13-F28. To address the upper function ranges, the throttle design incorporates a '+10' and '+20' key action. These keys, along with the standard numeric keypad, permit the full function range to be addressed. Here's how it's done:

1. While holding the **FUNC** key down, press the **1** key then release both keys simultaneously. The throttle will go into the '+10' mode and display will show the following:

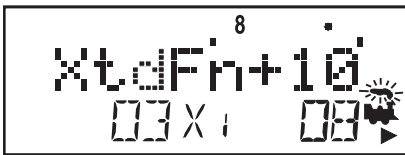

2. Select the second digit from the throttle's numeric keypad and you're done.
Example: To turn on function 18, just hold the **FUNC** key down while pressing the **1** key then releasing both keys simultaneously. Next press the **8** key, just press the **8** key again to toggle off. The figure '8' on the top line of the display will toggle on and off as will the locomotive's function.
3. Press the **FUNC** key once to exit the '+10' function mode and return to the normal single digit function mode. Note that you will have to return to the '+10' mode to check on whether any functions in that range are currently active.

12.3 Controlling Functions 20-28

1. While holding the **FUNC** key down, press the 2 Key then release both keys simultaneously. The throttle will go into the '+20' mode and display will show the following:

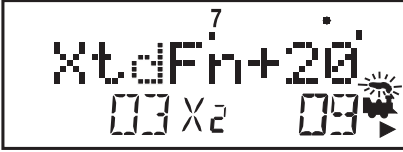

2. Select the second digit from the throttle's numeric keypad and you're done.
Example: So if you want to turn on function 27, just hold the **FUNC** key down while pressing the **2** key then releasing both keys simultaneously. Next press the **7** key. That's it. You've just turned function 27 on.
3. Press the **FUNC** key once to exit the '+20' function mode and return to the single digit function mode. Note that you will have to return to the '+20' mode to check on whether any functions in that range are currently active.

12.4 Controlling Functions On Consisted Locomotives

Even though an individual locomotive is part of a consist and you can't control its speed and direction separately from the consist, you can still control its function outputs independently as follows:

1. Press the **LOCO** key and select the address of the locomotive that is a part of consist for which you want to control functions.
2. Press the **LOCO** key again to select the loco address to your throttle. The speed value will show "cn" to remind you that you can only control functions on the loco and not its speed.
3. Use the steps described in Sections 12.0-12.3 above to turn on or off the functions on the consisted loco.

13.0 Tetherless Operation

13.1 General Tetherless Operations

All DT500s can operate without being plugged in using IR mode. This allows you to disconnect from the LocoNet and still control your locomotives while walking around your layout.

- The DT500/500D are all “InfraReady.” All come with IR LEDs that send infrared signals to the layout. To use this InfraReady capability, you just need to install one or more infrared capable receivers (UR90, UR91 or UR92) on your layout and enable IR in your throttle options. See section 15.1. Enabling IR mode will disable the use of expanded slots for your throttle. You will also need to install a known good 9-volt battery in the throttle.
- The DT500D is a duplex radio equipped throttle. To use your DT500D as a duplex radio throttle, you will need to install a UR92 duplex radio transceiver on your layout and a known good 9-volt battery in the throttle.

13.1.1 Selecting a Locomotive-Safety Selection

While unplugged, the DT500 (IR only) operates as one-way transmitters. Throttles operating in IR mode must be plugged into LocoNet to select an available locomotive address. After an address is selected, you can unplug from LocoNet and run the selected addresses with infrared.

The DT500D throttle has full duplex radio capabilities. Once the DT500D has been configured to communicate with a UR92, the full functionality of the DT500 series throttles can be enjoyed without plugging in.

13.1.2 Releasing An Address Using IR

There are two options available for tetherless release.

No tetherless release allowed: if the **LOCO** key is pressed while the DT500 is running in IR tetherless mode, the addresses selected will not be released unless the throttle is plugged in to LocoNet. This is the factory default, but can be changed in the throttle’s option setup. See Section 15.1 (IRRelease).

Tetherless release allowed: if the **LOCO** key is pressed while the DT500 is running in IR tetherless mode, the address selected on that side of the throttle will be released immediately and that throttle will become inactive. To re-select this loco address plug your DT500 in to LocoNet and select the loco address on the throttle.

13.1.3 Multiple Unit Operations While IR Tetherless

Consists must be assembled and broken up while the DT500 is plugged in to LocoNet. MU operations are locked out while the DT500 is running IR tetherless. Once a consist is assembled, it can be operated normally using the DT500 in tetherless mode. In Duplex Radio, the DT500D can assemble and break up consists without being plugged in.

13.1.4 Programming While Tetherless

Programming is not available when using IR tetherless mode.

In Duplex Radio, all programming modes are available while tetherless.

13.1.5 Switch Mode

The DT500 will operate in Sw mode while tetherless. It can operate turnouts and routes using the **OPTN / t** and **CLOC / c** keys in the normal manner.

13.1.6 Ballistic Tracking

While running tetherless, ballistic tracking will feel slightly different from when you are connected to LocoNet.

13.1.7 Fast Clock

When using the fast clock option, the DT500 will keep track of and display fast time based on the last synchronized system fast time when the DT500 was connected to LocoNet. If the fast time is edited by another throttle connected to LocoNet, the DT500 will not see this change until it is plugged into LocoNet at which time its display will be updated. In Duplex Radio, the DT500D will keep track of, and display fast time while tetherless.

13.1.8 Throttle Keypad Lock

While the DT500/D is being used tetherlessly, there are occasions when you may want to disable the throttle's controls to prevent accidental commands being sent to the layout. For example, your train is in a siding waiting for another train to pass. You put your throttle in your pocket and go take a break. By locking the throttle controls, you will not be able to accidentally start your train if you bump your throttle knob or press the **Y / +** key.

To lock/unlock the controls on your DT500

1. Press both the **Y / +** and the **N / -** keys at the same time. When you are locking the keypad be sure to press both the **Y / +** and the **N / -** keys AT THE SAME TIME to avoid sending a speed command to the active loco.
2. The throttle will display "Lock=+&-" in the display and none of the controls will function until you unlock them.
3. Press both the **Y / +** and the **N / -** keys at the same time again. This will return the throttle to normal operation.
4. Plugging the throttle into LocoNet will also unlock the throttle.

13.2 Using the DT500 Throttle In IR Mode

1. For Infrared operation, plug in at least one Digitrax IR receiver (UR90, UR91 or UR92) to your working LocoNet. Because infrared signals are line of sight, more than one receiver may be necessary for optimal performance in your layout room. *See wireless IR receiver instructions for more information about installing UR90s, UR91s and/or UR92s on your layout.*

2. Plug your DT500 Throttle with IR Mode enabled (see section 15.1) in to LocoNet and it will verify that at least one infrared receiver is connected LocoNet. Make sure a known good battery is installed in your throttle. The throttle will display Ir followed by the current LocoNet ID. The example below shows that the DT500 has detected a Ir receiver and that the current LocoNet ID is 01. The throttle has loco addresses 03 and 1280 selected.

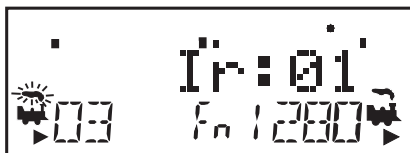

3. Unplug the DT500 from the LocoNet. The tetherless indicator on the display will come on and the tetherless message will display for a few seconds indicating that the throttle is running in Ir (infrared) mode. It will also display the LocoNet ID (00-07) that the throttle is logged on to.
4. When you single click or turn either throttle knob to activate it, the DT500 will show the normal operating mode Fn display with the tetherless indicator lit in the upper left corner of the display. Remember that in IR mode you have access to 9 functions (F0-F8).

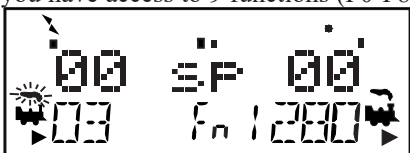

If an unplugged DT500 operating as a tetherless throttle detects no user throttle activity for about 3 minutes, it will enter power save mode show this display:

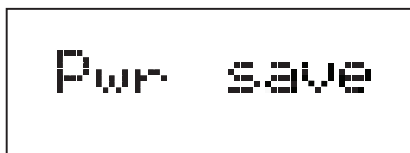

The throttle may flash the Fn mode indicator about every 60 seconds. This happens when the throttle “pings” to let the command station know that it is still part of the system. This keeps the system from releasing that locomotive back to the system and making it available to be selected by another throttle.

Press and hold the **EXIT** key to bring the throttle out of power save mode without making any changes to throttle settings. Any key strokes or movement of the throttle knobs will also bring the DT500/R out of power save.

13.2.1 LocoNet ID Change

Your DT500 will log on to the LocoNet ID offered by compatible infrared or simplex radio receiver it sees when plugged in to LocoNet. The default LocoNet ID is 00. It may be necessary to change the LocoNet ID if more than one club is operating in close proximity at a train show so that the commands sent by one club will not interfere with the commands sent by other clubs. .

To change a LocoNet ID:

1. Disconnect a DT500 from the LocoNet for which you want to change the LocoNet ID. If you are operating several throttles on your layout, it is necessary only to disconnect one throttle.
2. Press and hold down the **EDIT** key on the DT500 and then plug it back in to LocoNet. Release the **EDIT** key after plugging in the throttle.
3. The DT500 will display E1 in the Mode Indicator and the current LocoNet ID "Ir:0n" where "n" is the current LocoNet ID. Use the **R** throttle knob to change the LocoNet ID. You can set the LocoNet ID to be any number from 00 to 07. In the example below the LocoNet ID has been set to 03.

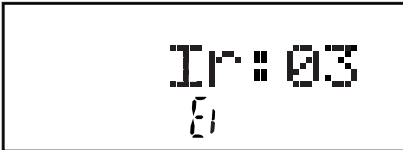

4. Press **ENTER** key to set the system to the new LocoNet ID.
5. The DT500 used to change the LocoNet ID will automatically log on to the new LocoNet ID.
6. Unplug and reconnect any other DT series infrared or radio throttles that will be used on this system so that they can log on to the new LocoNet ID number and be able to operate on the system.

13.2.2 Adding More UR90, UR91 and UR92s To LocoNet

If you add additional UR90, UR91 and/or UR92s to the system you must to re-synchronize the IDs by setting the LocoNet ID (0-7) as described above AFTER all the UR90, UR91 and UR92s you are adding are connected to LocoNet. It is also recommended that track power be cycled off and back on, throttles should be plugged in to resynch. If you are operating in an area where more than one LocoNet system is operating nearby, be sure to coordinate with other layouts so that each one has its own unique LocoNet ID before beginning operations.

13.4 Using the DT500D Throttle in Duplex Radio Mode

There are three elements involved in duplex radio operation between the DT500D and the UR92: Duplex Group Name, Duplex Group Channel, and Duplex Group Password. These elements can be configured to provide a unique connection when operating in a multisystem environment.

See the Quick Start setup guide, Section 2.0, for setting up the UR92 and Joining the DT500D to the Duplex Group. There are several additional operation and configuration options for the Duplex Group covered below.

13.4.1 Join a Duplex Group

The DT500D will remember the last Duplex Group that it joined and display that Duplex Group Name upon power on. If the Duplex Group is available, the DT500D will rejoin the Group. If the Group is not available, you will get an Idle screen. To select a Group, follow these instructions

1. Make sure there is a battery installed in the DT500D and turn on the throttle. Press the **OPT / T** key. (If you are starting from the Idle screen hold the key down for 3 seconds to power up the Throttle.) You will see:



2. Press the **FIND** key to display the rf search mode and scan the last active channel. ScanNets will briefly appear on the display and if there is no Group available on the last Channel used (19 in our example) you will see:

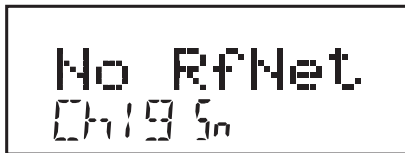

3. Press the **Y / +** or **N / -** key to change the Channel up or down. At each channel the display will show "hit Find" to search for a Duplex Group name operating on that channel.



- When the DT500D discovers a Duplex Group the name will blink in the display. In the example below, the Group Name is the default (Dtx0048) for a UR92 that has been installed in another system.

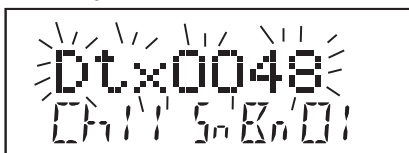

- Press the **ENTER** key to join the Group and then select the loco address you want to run on the layout. You are now ready to run your train.

13.4.2 Configuring the Duplex Group name

The UR92 ships from the factory with a default Duplex Group name of "Dtxnnn", where nnnn is the serial number. It is easily changed using the following steps:

- Plug a DT500D throttle into the UR92.
- Press the **EXIT** key.
- Press the **OPTN** key then the **EDIT** key.
- Turn the **L** Throttle knob to position the cursor. The character will blink to show it has been selected.
- Turn the **R** Throttle knob to choose the character. The character will continue to blink until you move to the next position or press the **ENTER** key.



- Repeat steps 3 and 4 until desired name is obtained.
- Press the **ENTER** key to change the Duplex Group name. DT500D throttles will need to rejoin on the new Group name.

13.4.3 Configuring the Duplex Group Channel (11-26)

The UR92 ships from the factory with the default Duplex Group default radio channel set to 11. You can select channels 11 through 26 for the radio channel.

1. Plug a DT500D throttle into the UR92.
2. Press the **EXIT** key.
3. Press the **OPTN** key then the **EDIT** key.
4. Press the **Y / +** key to increase the channel number, or
5. Press the **N/-** key to decrease the channel number. In the example below, we have changed the Group name to JBS&J RR and entered 21 for the channel number.



6. Repeat step 4 or 5 until desired channel appears in the display.
7. Press the **ENTER** key to change the **Duplex Group Channel#** for the UR92. DT500D throttles will need to rejoin on the new channel #.

13.4.4 Configuring the Duplex Group Password (Key)

The UR92 ships from the factory with the default Duplex Group Password of 0000, *the value that disables password requirements*. You may have an occasion when operating in a multisystem environment when you may want to restrict access to your layout and operating system via a tetherless Duplex Throttle. The password for your Duplex Group may be activated or changed:

1. Plug a DT500D throttle into the UR92.
2. Press the **EXIT** key.
3. Press the **OPTN** key then the **EDIT** key.
4. Enter a 4-digit number using the numbers on the keypad (0001-9999). In the example below we have entered 1981 as the Duplex Group Password.

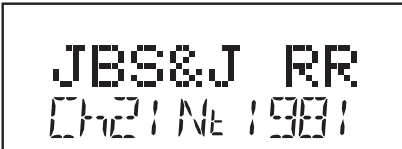

5. Press the **ENTER** key to change the Duplex Group Password for the UR92. The throttle will save the new settings in the UR92 and revert to normal operation. 8.4.3 Configuring the Duplex Group Channel (11-26)

14.0 Advanced Operations Capabilities

14.1 Multiple Unit Operations

Digitrax command stations offers three methods of consist control:

1. **Basic Consisting**
2. **Advanced Consisting**
3. **UniVersal Consisting (the Digitrax preferred method)**

For complete information about these methods, please consult your Digitrax Starter Set Manual.

By definition, Digitrax always adds loco addresses to the “TOP” loco address in a consist.

The “TOP” loco is special, in that it is the address that receives the speed and direction commands for the entire consist.

All non TOP loco addresses added to the consist are controlled by commands sent to the “TOP” loco.

The TOP locomotive does not have to be a physical loco on the track, it can be a phantom.

Digitrax defines the TOP loco as the loco on the **R** Throttle knob at the time when the MU add is performed.

All loco addresses in a consist will have the same status as the TOP loco. They will all be common, in-use or idle based on the state of the TOP loco.

Each loco within a consist maintains its original advanced 28/128 or standard 14 speed step mode setting.

A consist can be released by one throttle and then selected and run by any other throttle.

A consist TOP address can be dispatched and acquired on another throttle just like any other address. See Section 10.7.

14.1.1 Adding a Locomotive To A Consist

DT500 throttles must be plugged in to LocoNet to add loco addresses to consists. DT500D may perform this untethered.

1. Select the loco address of the TOP loco on the **R** Throttle knob.
2. Select the address of the loco you want to consist to the TOP loco on the **L** Throttle knob.
3. Move the two locomotives into position. The locomotives can be headed in either direction. They can be adjacent to each other in the train or one unit can be the mid train helper or a pusher on the end of the train.
4. Before consisting the locos, make sure that both are traveling in the **SAME PHYSICAL DIRECTION ON THE TRACK**. (The direction indicators may or may not match, the important thing is that the locomotives are set up to move in the same direction and are not pulling against each other.)

- Press the **MU** key, the display will show the following:

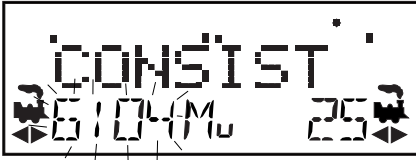

the MU mode indicator on the display is lit. The loco address in the **L** side of the display will blink to show that it is the address that will be consisted to the address on the **R** Throttle.

- The DT500 display will prompt you to press the **Y / +** key to add the loco address or the **N / -** key to remove the loco address from the consist controlled by the TOP loco address selected on the **R** Throttle. You will see the display alternate between the following two screens to remind you of which key to press.

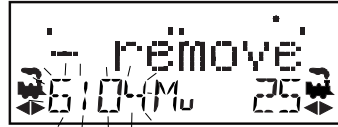

- Press the **Y / +** key to add the left address to the consist.



The **L** Throttle display shows the address of the loco that was added to the consist with a **cn** in the text line above it. The **R** Throttle display shows the address of the TOP loco address and its current % of full speed. The **R** Throttle is now in control of the speed and direction of both locomotives in the consist.

- Once a consist is set up and linked to the TOP locomotive, this TOP loco can be released and selected to run from either throttle on your DT500. The consist can also be dispatched to another throttle.

You can access the functions of the any loco in the consist by selecting the consisted loco to a throttle and using the function keystrokes outlined in Section 12.4 You will not be able to change the speed or direction of any loco that is part of a consist while it is consisted unless it is the TOP loco.

14.1.2 Removing A Loco From A Consist

DT500 throttles must be plugged into LocoNet to remove loco addresses from consists. A DT500D can perform this without plugging in.

1. Select the loco address that you want to remove from a consist on the **L** Throttle.
2. Press the **MU** key to enter consist mode.
3. Press the **N / -** key to remove the loco address from the consist.
4. The **L** Throttle automatically becomes active with the loco you just removed from the consist. If you remove the loco from the consist while the consist is moving, the removed loco will be broken out of the consist at the same speed and direction that it was moving in the consist. You can uncouple and run the removed loco as an independent loco again!

14.1.3 Nested Consisting

The loco that was selected in the **L** Throttle to be added to the consist can itself be the “TOP” loco of another consist. When it is added to the current **R** Throttle “TOP” loco it will become a “nested” consist. In this case the whole nested consist is linked and becomes part of the new consist.

The loco that is selected in the **L** Throttle to be removed from the consist can itself be the “TOP” loco of a nested consist that was linked into the current **R** Throttle “TOP” loco. In this case the whole nested consist is removed from the consist and returned to the **L** Throttle as a consist.

14.1.4 MU of Mismatched Locomotives

If all the locomotives in the consist have performance characteristics that are closely matched, you can run all the consisted locomotives in 128 step mode. If the units are completely mismatched (for example if you are running two different brands of locos with noticeably different characteristics), then we recommend speed matching the locos by programming Loadable Speed Tables (See your Mobile Decoder Manual more information).

14.2 Sw (Switch) Mode

Switch mode is used for sending commands to accessory decoders and for changing option switches in your LocoNet system components. The most common use of switch mode is for operating turnouts. When you enter Switch mode, the throttle knobs and direction keys will continue to control the loco addresses running on the throttle. Loco speed will be displayed on the bar graph and loco direction will be displayed on the direction indicators for each throttle.

To change the position of a switch or turnout

1. Press the **SWCH** key to enter Sw (switch) mode.
2. The last switch (accessory) decoder address selected by your throttle is displayed on the text line followed by a “**t**” or “**c**”.

- 3 The display indicates the switch position using the “t” or “c” as follows:
 - “t” indicates that the switch is “thrown”
(for a turnout, the diverging route is set)
 - “c” indicates that the switch is “closed”
(for a turnout, the mainline route is set)

If the “t” or “c” indicator is flashing it means that the LocoNet Command Station does not know the current switch position. A steady “t” or “c” indicates that the command station knows the position of the switch.



4. Use the numeric keypad to enter switch number and the **OPTN / t** and **CLOC / c** keys are used to tell the switch in which direction it should operate. Use the numeric keypad to enter the switch address you want to change.
5. Once the desired switch address appears in the text area of the throttle, you will see either “t” or “c” on the right side of the = sign in the display. If the “t” or “c” is flashing, the command station does not know the position for this turnout. Press the **OPTN / t** key to move the switch to the “thrown” position OR the **CLOC / c** key to move it to the “closed” position.
6. If the switch you selected is a turnout connected to an accessory decoder, it will change position from closed to thrown or vice-versa. If the switch you selected is an option switch setting for your command station or other LocoNet component, the software switch inside the command station or other component will be changed.
7. After commanding the switch “closed” or “thrown” the switch position display will stop flashing, since the command station now knows the current switch position.
8. When you have finished your Sw (switch) operations you can return to Fn (Normal Operating Mode) by pressing the **EXIT** key or the **FUNC** key .
9. The next time you enter Sw mode, the DT500 will remember where you left off and start at the last switch address and position you accessed.

Note: Accessory (turnout) decoders in the system are accessible to all throttles and control devices with switch control capabilities and are not reserved in-use to a single throttle like locomotive decoder addresses.

14.3 Fast Clock and Routes

Any DT500 throttle can edit system functions like the fast clock and routes. Both of these features can be enabled or disabled by your command station. The DCS210 ships with fast clock and routes enabled.

14.3.1 Fast Clock Basics

Many operators use a fast clock during operating sessions to simulate prototypical operations. Traditionally, this clock is on the wall and is set up to run at a faster than normal rate. LocoNet has its own networked fast clock for all Digitrax throttles connected to your system.

The fast clock display is a 4 digit 12 or 24 Hour format clock. To display the fast clock simply press the **CLOC / c** key. The fast clock display will remain active while you are running trains until you initiate another throttle task such as loco address selection, programming, MU, Switch mode, etc. To stop displaying the fast clock and return to the default display, press the **CLOC / c** key again. This is the display you will see:

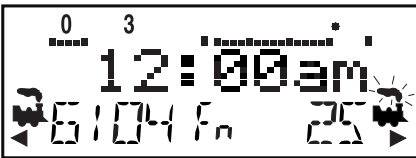

Any DT series throttle that is plugged in to your LocoNet system will update its fast clock time and rate to be synchronized to the rest of the system a couple of seconds after it is connected to LocoNet.

Each DT4xx can be set up with an alarm. When the current fast clock time matches the private alarm time set in any DT500, that DT500 will beep and flash the message “Alarm” to indicate that the alarm time has elapsed.

The fast clock rate for the fast clock is user selectable from 1:1 to 100:1 in steps of 1. The most popular range of values is 4:1 to 8:1.

14.3.2 Stop the Fast Clock

Setting the clock rate to 00 will stop the fast clock for the entire system at the currently displayed time. Fast time will re-start when a new non-zero rate value is set.

The current fast clock time, fast clock rate and the DT500 alarm time can be changed by using the Edit mode.

14.3.3 Edit Fast Clock Time, Rate and Alarm

DT500 must be plugged in to LocoNet to edit the fast clock settings.

1. From Fn mode, press the **EDIT** key to change to Edit Mode.
2. Press the **EDIT** key to scroll through the different things you can edit.
3. The first time you press the **EDIT** key, the mode indicator in the center of the bottom row of the display will show Ec (Edit Clock Mode) and the text

area will show a 12 hour time. See your throttle manual for setting the clock for 12 or 24 hour operation.

4. Use the Throttle knobs to dial up the “current” time. Use the **L** Throttle for hours and the **R** Throttle for minutes. You can only move time forward. Press the **EDIT** key again to set the time and move on to edit the fast clock rate.
5. When you press the **EDIT** key the second time, the mode indicator will display Ef (Edit Fast Rate) and the text will show Rate=nnn where nnn is the clock rate. Use the throttle knobs to dial up a clock rate that is between 000 and 120 (the throttle will let you dial up to 255 in this case but values above 120 have no meaning to the system). Press the **EDIT** key again to set the fast clock rate and move on to edit the throttle alarm time.
6. Once the time and fast clock rate are set, the mode indicator will display EA (Edit Alarm) and the text will show a 12 or 24 hour time. Use the throttle knobs to dial up the alarm time. Press the **EDIT** key again to set the fast clock alarm. NOTE: The fast clock alarm can’t be turned off.
7. Once the time, fast clock rate and alarm are set, you will automatically return to Fn Mode unless your system is enabled for other types of editing such as routes. If you are set up for command station routes, the clock editing screens will be followed by Er for editing routes as described in the system manual for command stations that support internal routes. To exit Edit mode at any time simply press the **EXIT** key.

14.4 Route Basics

You can use your DT500 with the DCS210 to set up routes that are triggered by operating a single turnout address to make it either **c** (closed) or **t** (thrown). Setting up and operating routes is similar to consisting locomotives because you can cause more than one unit to operate based on a single command sent to the system. We call the turnout address to which other turnout addresses are “consisted”, the TOP address. To operate a route, use Sw (Switch) mode to select the TOP turnout address in the route and move it to either **c** (closed) or **t** (thrown) to initiate the route you have previously set up in your route list. The TOP turnout address does not need to be physically present on the layout, it can be a “phantom” turnout address.

The DCS210 supports up to 64 routes. Each route consists of a list that contains a TOP turnout address and its position **c** or **t** and up to 16 other turnout addresses and their positions. Routes are stored in the DCS210’s memory and can be operated by any throttle in the system that can send switch commands. Each of these 64 routes is operated by setting the TOP turnout address to the position saved in the route list. When a route is triggered, a route can include a switch that is the Top of another route and all the entries in the second route will be added to the string of turnout commands the initial route request generates. The second route called is a “nested” route.

From the initial route you can “nest” up to 3 levels deep. Note that a route that itself does not contain another Top switch (i.e., another route) will not increase the nest depth. You can combine routes as needed to issue a maximum of 120 switch commands.

When executing a route the DCS210 will check to see if it exceeds these limits or contains the same switch command more than once. If the route exceeds the 120 switch maximum the DCS210 will short beep 8 times. If the route contains the same switch command twice or “loops” on itself the DCS210 will short beep 5 times. When the DCS210 indicates these errors no switch commands will be issued. You will need to edit the route and correct the errors in the list before trying the command again.

14.4.1 DCS210 Routes OpSW

By default the DCS210 is set to enable routes. OpSw #26 enables and disables routes. To disable routes set OpSw #26 to **t** (thrown). *See section 8.2 for instructions for changing OpSws.*

You can erase all current routes in the DCS210 by setting OpSw 37 to **c** (closed) and returning to Run mode.

You can disable LocoNet Route Echo by setting OpSw #25 to **c** (closed). This will prevent the DCS210 from sending Route commands via LocoNet they will only go out over the track.

14.4.2 External Routes

The DS64 stationary decoder can also generate cascade switch message commands or routes independently of the DCS210’s capability. See the appropriate manuals of these products for further details.

14.4.3 Setting up Routes using the EZ RTS button

To Set routes:

1. Press the EZ RTS button. DCS210 will issue 3 short beeps and PROG indicator will blink on once a second.
2. Using your throttle in switch mode select the turnout address to set as the Route ID. Press **c** to close the switch and set the Route ID. The DCS210 will make 1 long beep indicating it is ready to add turnout addresses to the route.
3. Select the first turnout address in your route and press as **t/c** to set the turnout position in the route. This first address will be your TOP address and the one you use to access the route when operating.
4. Continue selecting turnout addresses (including other route’s TOP address) in this manner until you have reached the 16 turnout maximum or you are ready to end your route.
5. To end the route enter the same turnout address twice in sequence. The DCS210 will long beep 2 times indicating it is saved and exited Easy

Routes. The DCS210 will also save and exit Easy Routes if more than 16 turnout addresses are entered. If you create a route that loops back on itself the DCS210 will short beep 5 times and exit Easy Routes saving up to your last entry.

6. To set another route start with step 1 and repeat the process.

14.4.4 Edit Routes Using Your DT500 throttle.

To go to the Edit Routes (Er) mode you must pass through the clock editor:

1. Start in Fn mode. Press the **EDIT** key to enter Edit Mode.

Press the **EDIT** key again to enter Ec (Edit Clock) mode.

Press the **EDIT** key again to enter EF (Edit Fast Rate) mode.

Press the **EDIT** key again to enter EA (Edit Alarm) mode.

Press the **EDIT** key again to enter Er (Edit Routes) mode.

The DT4xx's display will show the following screen when you enter the Edit Routes mode.

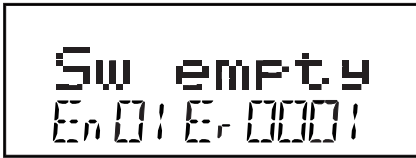

This display shows Er (Edit Routes) in the Mode Indicator area on the bottom row to let you know you are in Edit Routes mode.

The right side of the bottom row shows which route (Route ID) you are working with. This can be any number from 01 through 64.

The left side of the bottom row of the display shows which entry within the route you are working with. The En (entry) number can be any number from 01 through 16. *With some legacy throttles you may only have access to 01-08.*

En01 is the TOP or controlling turnout address. The position, "t" or "c", that you set for this turnout address is the one that will operate the route.

The text area shows "Sw empty" to let you know that nothing has been entered for Entry 01, Route 01.

2. Use the **R** Throttle knob to dial up the Route number you want to work with. The bottom right display will show the route number 01-64.
3. Use the **L** Throttle knob to dial up the Entry number within the chosen route that you wish to work with. The bottom left display will show the entry number.



This display shows Entry 01, Route 11 as empty.

4. Press the **ENTER** key and “Sw” in the text area will begin to flash, use the Throttle knobs to dial up the turnout address you want to add to the route. Use the **L** Throttle knob for 100s and the **R** Throttle knob for 10s and 1s. Once you make changes to the turnout address number or the position of that address, the entire text area will begin to flash. The key pad is not active during this throttle task even though some keys may change the display.
5. When the turnout address you want is on the screen use the **OPTN / t** key to set the turnout to **t** (thrown) or the **CLOC / c** key to set the turnout to **c** (closed).



This display shows Entry 01, Route 11 with turnout address 005 set for **c** (closed). In this case address 005 is the TOP address for this route because it is Entry 01 for the Route.

6. If you don't want to make any changes to the route and entry selected, simply press the **BACK** key or either of the Throttle knobs to exit turnout address/position editing and return to selecting a different route/entry number (step 2 above).
7. Once your selection is complete, press the **ENTER** key to save the turnout address in the position selected into the route.
8. Continue entering route entries in this manner until your route is complete. You can toggle back and forth between selecting route and entry numbers and entering turnout addresses and positions by pressing either Throttle knob or the **BACK** key.
9. Once you have finished editing routes, press the **EXIT** key to exit the Er (Edit Routes) mode and return to Fn (Normal Operating) mode.
10. To operate the routes that you have set up, simply press the **SWCH** key, key in or dial up the TOP turnout address for the route and press the **OPTN / t** key or the **CLOC / c** key to issue the appropriate **t** (thrown) or **c** (closed) command. When you select the TOP turnout address in a route and the position command (**c** or **t**) you issue matches the position that is

stored in the route, the route will operate. If you select the opposite position from that stored as the route, the TOP turnout address will change to that position and the route will not operate.

Note: If there is an error with the route the DCS210 will beep 5 times.

14.5 Query Mode

The DT500 has access to internal statistics and flags in Advanced LocoNet Devices like the DCS240 and DCS210. These can be useful in troubleshooting and diagnosing issues with your system. The DT500 can access up to 10 different device's statistics and report a variety of internal states. The DT500 displays a "snapshot" of the statistics and must be refreshed to see any changes. DT500 and throttles operating in IR mode must be plugged in to access Query mode. DT500D throttles can access Query mode while tetherless.

To access Statistics:

1. Press the **PWR** key then the **DISP** key to enter Query Mode
2. The Throttle will display a Qx, in the Mode indicator area, where x is the device number.
3. To switch between Devices press the **Y/+** and **N/-** keys
4. Use the Right hand throttle knob to scroll through available statistics
5. Press the **DISP** key to refresh displayed statistics
6. Some counters may be reset by pressing "0" on the keypad.

Q0 and Q1 are reserved for Command Stations. This is useful for comparing two different command stations, you will not be able to operate your layout with two Command Stations attached to LocoNet

Q2 – Q9 are reserved for other devices, DCS240s and DCS210s set as Boosters, along with other compatible devices will be displayed here.

Please refer to www.digitrax.com or your your compatible device manual for a listing of the devices' available reported statistics and flags.

14.5.1 DCS210 Reported Statistics

Statistics are divided into 5 categories, Electrical (ELE), LocoNet (Lnt), Flags (FLG), Slot (SLt), and Track(tRK). Each category is represented in the Left Throttle address area of the display.

Category	Display	Info Shown
Lnt	D:DCS210	Displays the device type
Lnt	S#c XXXX	Shows device serial number
Lnt	HWverX.X	Shows hardware version
ELE	SWverX.X	Shows software version
ELE	VtrkXX.X	Shows approximate current track voltage
ELE	Vin XX.X	Shows approximate current input voltage
ELE	Iin X.X	Shows approximate current drawn
ELE	Ilim X.X	Shows current limit, this will usually be either 5.0 or 8.0. If this value is not 5.0 or 8.0 your unit is likely in safe operation mode and there is a mismatch between input voltage and track voltage.
ELE	Vrs XX.X	Shows Rail Sync Voltage
ELE	VIn	Shows LocoNet Voltage
Lnt	Msg	Shows number of good LocoNet Messages, can reset by pressing 0
Lnt	Bad	Shows number of Bad LocoNet Messages, can be reset by pressing 0
Lnt	Slp	Shows number of times the system has been put to sleep
FLG	Itrk Max	Flag ON indicates Maximum current reached
FLG	Vin Lo	Flag ON indicated input voltage is low
FLG	Vin Hi	Flag ON indicates input voltage is high
FLG	Rsyn Max	Flag ON indicates railsync is below recommended voltage
FLG	Fuse Bad	Flag ON internal fuse is bad, needs to be replaced
FLG	Overtemp	Flag ON unit is overtemp
FLG	LnetVmin	Flag ON LocoNet Voltage below recommended voltage
FLG	PtrkIsol	Flag ON Track Voltage was detected on the programming output when programming was attempted.

Category	Display	Info Shown
FLG	PtrkMaxI	Flag ON programming tack over current limit
FLG	TrkI Lim	Flag ON, unit is in Safe operations mode
FLG	USB Link	N/A
SLt	UsedXXXX	Shows number of Slots used
SLt	IdleXXXX	Shows number of Idle slots
SLt	FreeXXXX	Shows number of Free Slots
SLt	CtopXXXX	Shows number of Consists (TOP Locos)
SLt	CupXXXX	Shows number of locos in a consists excluding TOP locos
tRk	FltXXXX	Shows number of track fault events
tRk	ArvXXXX	Shows number of Auto-Reverse events
tRk	DstXXXX	Shows number of track disturbances

Find additional information at www.digitrax.com

14.6 Input Mode

Input mode allows you to see changes in detection sections as reported from BD4s, BDL168s, and other detection devices. The throttle will display InXXXX=L or InXXXX=H, where the XXXX equals the detection section number and if it is reporting Low or High. This can be a useful troubleshooting tool.

To enter Input Mode:

1. Press the **PWR** key followed by the **REVERSE / R** key.
2. The screen will display In=XXXX and the mode indicator will display In
3. Press the **EXIT** key to exit input mode.

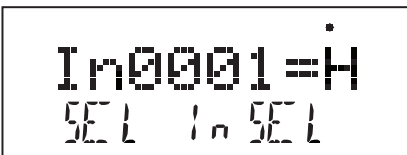

Please refer to www.digitrax.com for more details on how to utilize Input Mode.

14.7 FIND Key and Digitrax Transponding

On layouts set up for Digitrax transponding with transponders in locos and rolling stock and transponder receivers installed on the layout, the DT500's **FIND** key is used to turn on the find command. This lets you see the zone location of transponders on the layout in your throttle display. To use the FIND Command:

1. The layout must have Digitrax transponder receivers (BDL168 and RX4s) installed and configured.
2. The loco or other rolling stock that you want to track must have a transponder installed. This can be either a transponding decoder or a stand alone transponder.
3. Select the address of the transponder you want to track on the active throttle on your DT500 (the one with the flashing smoke icon). Find can only be active for one address at a time.
4. Press the **FIND** key, the display will show a screen similar to one of the following examples:

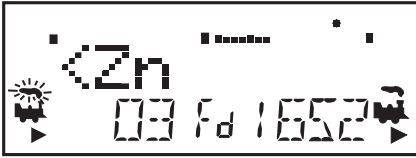

This example shows a DT500 in FIND mode for address 03 selected on the **L** Throttle. The system is not able to find address 03 so there is no display after the <Zn. Either the loco or rolling stock with address 03 is not present on the layout or it does not have a transponder or it is located in a zone that does not have a transponder receiver.



This example shows a DT500 in FIND mode for address 1652 selected on the **R** Throttle. The system sees address 1652 in Zone 0010 moving at about 50% of full throttle. When address 1652 moves to another Zone, the display will automatically update to show the new Zone location.

5. Find will remain active until you press the **FIND** key again to disable find mode.

15.0 Customizing Your Throttle - Step-by-Step

15.1 Changing the Throttle Options

You can change the option settings for each DT500 throttle to customize the way it operates. It is recommended that options settings changes be made while the throttle is plugged into an active LocoNet.

Following the instructions on accessing the Options menu is a chart listing in menu order the Option name as it appears in the DT500 display, a brief description of the Option and the factory default for each. There is also room on the chart for keeping track of your changes to the default settings.

The FactoryD option allows you to easily set the DT500 Options all back to factory defaults.

1. Press the **OPT / t** key to access the Options menu.



2. Use the **R** Throttle to scroll through the options. They are in the same order as the following charts. The names will blink during this part of the process.
3. Use the **Y / +** or the **N / -** key to toggle through the values for each option until the desired value appears on the screen.
4. To change another option, repeat steps 2 and 3.
5. Press **EXIT** key at any time to cancel all of your changes
6. When you are satisfied with the changes, press the **ENTER** key to set all of the changes at once.
7. You can return to the factory defaults by resetting the last option, FactoryD to On and pressing the **ENTER** key.

DT500 Option Screen	Description	Options (Default in Bold)	My Setting
Duplex RF	On enables RF24 to operate in Duplex mode. Off turns off Duplex choice	On Off	
IR mode	On enables IR mode when disconnected and IR receiver detected on LocoNet Note: Enabling will disable the use of expanded slots	Off On	
Throt ID	Optional unique throttle ID#	527F	
XP Slots	Enable or disable the use of Expanded slots when available	On Off	
RPdn->20m	On enables throttle to power off after being in power saver for 20 minutes	Off On	
XPFnHold	On allows multiple expanded function keys per X1 or X2 choice	On Off	
noIDLSho	Off allows "Idle" to flash in right hand loco address area when system is Idle	Off On	
Clicks	On enables clicking when making any key-pad or knob changes	On Off	
Fclock	On enables Fast Clock in center display	Off On	
12HrClock	On selects 12Hr vs 24Hr clock display mode	On Off	
NoBlstic	Off enables ballistic tracking by proving rate-sensitive knob steps so faster turning gives bigger step changes	Off On	
STimeout	On shortens the amount of time before the throttle kicks into Power Save when no changes have taken place	On Off	
F3Static	On makes F3 key On/Off action	On Off	
F2 Mom	On makes F2 key momentary action, used for playable whistle where available	On Off	
F2Analog	On enables optional F2 key pressure- sensitive analog mode	Off On	

DT500 Option Screen	Description	Options (Default in Bold)	My Setting
MsgFilter	On stops throttle messages from displaying when selecting locomotives	On Off	
SLFollow	On enables slot following mode for locomotives selected in multiple throttles	On Off	
ES->Idle	On freezes all locomotives when Emergency Stop key pressed. Off stops only locomotive selected in throttle	Off On	
PWRSaver	On enables Radio/IR mode power save on throttle inactivity	On Off	
IRRelease	On allows IR/Simplex Radio throttles to release loco addresses when unplugged	Off On	
DplxBad	On enables white flashlight LED to blink when repeated Duplex radio messages fail.	On Off	
DxRxLPwr	On enables maximum Duplex power saving, disables continuous update of slot following	On Off	
NewTypes	On allows throttle to override command station new- type loco speed step settings	On Off	
Nu Type=	128 speed step setting 14 speed step setting reserved 28 speed step setting Advanced 128 speed step setting reserved Advanced 28 speed step setting	128 14 tR1 28 128A RES 28A	
Recall#	Recall stack set at last 4 entries Recall stack set at last 8 entries Recall stack set at last 16 entries	RC04 RC08 RX16	
BackLite	Maximum backlight brightness Maximum backlight brightness-lowest power usage	MAX 2 1 MIN	
FactoryD	Select ON and press enter key to force all options settings to factory defaults	On Off	

16.0 Programming Configuration Variables (CVs)

The decoders installed in your locomotives provide you with the ability to create a more realistic operating experience through the configuration variables (CVs for short). The DT500 series of throttles support configuration of up to 1024 CVs!

It is a good idea to run your decoders with the default CV values that come pre-programmed in your decoders until you get used to the performance characteristic and how they work on your layout. Once you are comfortable with running the trains, then you can begin customizing loco characteristics.

Each CV (configuration variable) controls a specific characteristic of the decoder, which in turn controls how the locomotive performs. See your decoder manual for a list of the most commonly used CVs and their meanings.

Each decoder comes pre-programmed from the factory with the default settings outlined in your decoder manual. You can change your decoder's performance characteristics by changing the CV values entered in the CVs you want to change. Each of these CVs can be set up when your command station is in the programming mode. The CVs are remembered in the decoder until it is reprogrammed to with a different CV value. Please refer to your Digitrax Mobile Decoder Manual for a complete listing of the CVs supported by each decoder.

It is a good idea to run your decoders with the default CV values that come pre-programmed in your decoders until you get used to the system and what it can do for you. Once you are comfortable with running the trains, then you can begin customizing loco characteristics.

Important Note on Programming:

Programming decoder CVs is usually done on an isolated programming track and the following examples use that method. *See your Starter Set Manual for details on setting up the programming track.*

Throttles operating in infrared must be plugged in to LocoNet to program CVs on the programming track and for Ops Mode Programming. Duplex radio throttles can program without plugging in.

The latest information on Digitrax Decoders is available online for download at **www.digitrax.com** in the Manuals and Instructions section.

16.1 Programming Mobile Decoder Addresses

1. Be sure that only the loco you want to program is on the programming track. If you are using operations mode programming, the loco you want to program can be anywhere on the layout but it must have a decoder that is capable of ops mode programming installed.
2. Press the **PROG** key to enter programming mode. The DT500 will display the following to show you are in the Program mode:

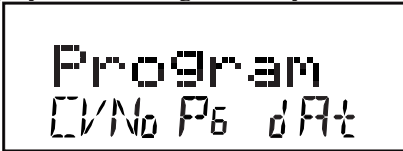

"CVNo" on the left side indicates that configuration variable numbers will show on the left and "dAt" on the right side indicates that CV values or data will show on the right side of the display.

The mode indicator in the center of the bottom line of the display shows which programming mode the throttle was using the last time it was in programming mode. Press the **PROG** key to cycle through the following options:

PG = Paged mode

PH = Physical register mode

Pd = Direct mode (Digitrax Preferred Programming Mode)

Po = Operations mode .

3. After a few seconds, the display will display the last CV and CV Value you programmed. If the display does not show Ad2=???, turn the **L** Throttle knob counterclockwise until you see Ad2 in the left side of the display:

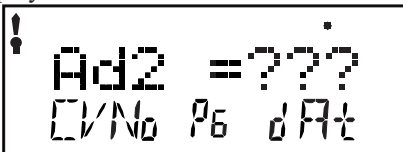

4. If you want to program a 4 digit address, press the **R** Throttle knob once to change the display to:

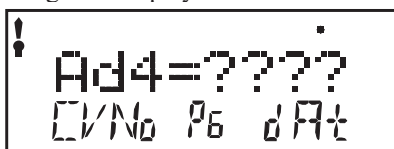

You can toggle between 2 and 4 digit address programming by pressing down

on the **R** Throttle knob.

- Digitrax recommends using the Pd, or Direct mode for programming all Digitrax decoders when using service mode on the programming track. You can use the **PROG** key to select which programming mode you wish to use. Press the **PROG** key to toggle between PG, PH, Pd, and Po. If you are using non-Digitrax decoders you can change to another mode if they are not capable of direct mode.
- To program a 2 digit address, use the **R** Throttle knob to dial in the address or use the keypad to enter the address. In the example below we have pressed the 3 and 9 keys to enter the loco address, 39. Press the **ENTER** key to program the decoder.

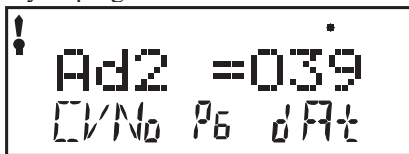

Note, when programming a 2 digit address, the decoder automatically enables 2 digit addressing.

- To program a 4 digit address, simply enter it on the keypad. In the example below we have simply pressed **9, 9, 8, 3**, on the keyboard to enter the loco address, 9983..

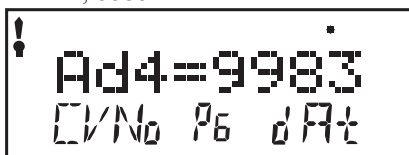

Alternatively, you can use the DT500's Throttle Knobs to dial in the 4 digit address you want to program. Use the **L** Throttle to dial up 1000s and 100s and the **R** Throttle to dial up 10s and 1s. Press the **ENTER** key to program the decoder

- When the **ENTER** key is pressed, the throttle will beep and display Ad2=0wr or Ad4=0wr followed by a blinking square during programming. When complete the display will show the 4 digit address that you just programmed and enabled.

Note: When Programming a new 2 or 4 digit address the throttle will automatically set CV29 to the default value for either 2 or 4 digit addressing. If you have customized your CV29 settings you will need to reprogram CV29 after changing the loco address.

- Press the **EXIT** key to quit programming mode and return to normal operations. Or if you want to continue programming additional CVs, see the next section.

10. If your command station is a DB150 and you are using any method other than Operations mode for programming, you will need to turn track power back on after you complete programming. Press the **PWR** key, then press the **Y / +** key, then press the **PWR** key to exit power mode.

16.2 Programming CVs Other Than Addresses

There are 1024 different CVs that have been defined to handle many characteristics you might want to use for your locomotives. Your decoder manual has a complete listing of CVs that are available in specific decoders, what they do and suggested values for each CV.

1. Place the decoder equipped locomotive you want to program on the programming track. If you are using operations mode programming, the loco you want to program can be anywhere on the layout but it must have a decoder that is capable of ops mode programming installed.
2. Enter Program Mode by pressing the **PROG** key. The display will show the last CV and CV Value you programmed. In the case below, it is the last loco address

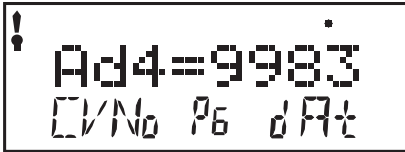

3. Select the programming mode you wish to use by pressing the **PROG** key until the method you want appears in the Mode Indicator. Digitrax recommends using the Pd, or Direct mode for programming Digitrax decoders when using service mode on the programming track.
4. Turn the **L** Throttle to begin selection of the CV# you want to program. You will see the **!** icon displayed on the left of the DT500 display when you are entering CV Numbers. You can dial up the number using the **L** Throttle or you can use the keypad to enter CV#s 01 through 1024.

5. Press the **R** Throttle to activate the CV value. You will see the **!** icon displayed on the right of the DT500 display when you are entering CV Values. Use the **R** Throttle to dial up or the keyboard to enter the CV value you want. CV values are displayed as decimal numbers (0-255) by default.

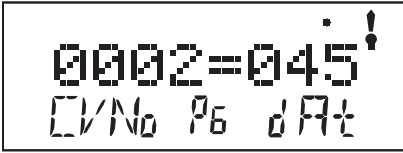

Remember that you can press the R Throttle to toggle the CV value display between decimal and hex as shown below.

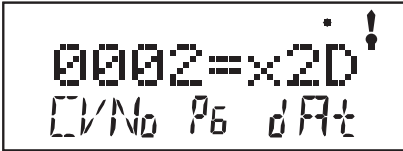

6. Press the **ENTER** key to program the selected CV value into the selected CV number.
7. Press the **EXIT** key to quit programming mode and return to normal operations. You can program as many CVs and their values as you want in a session. When you are finished, press Press the **EXIT** key to quit programming mode and return to normal operations.
8. If your command station is a DB150 and you are using any method other than Operation mode for programming, you will need to turn track power back on after you complete programming. Press the **PWR** key, then press the **Y / +** key, then press the **PWR** key to exit power mode.

16.3 Operations Mode Programming

Operations mode programming lets you program CVs in locomotives equipped with Extended Packet Format decoders while they are on the mainline. A typical use for Ops mode programming would be to change the acceleration rate (CV03) or the deceleration rate (CV04) of your locomotives to simulate the weight and braking capability of the train to compensate for changing the number of cars or power units on a train.

Your DT500 can use ops mode programming to change the CV value in ANY CV, including 2 digit and 4 digit addresses.

Ops mode programming can be performed by any DT500 at any time since the throttles are not competing for usage of the single programming track.

DT500 throttles must be plugged in for Ops Mode. DT500D throttles can do Ops Mode Programming wirelessly.

How to use Operations Mode Programming

1. Select the DCC loco address that you want to program on either the **L** or **R** Throttle. Be sure that the address you want to program is the active throttle, the one with the blinking smoke when you enter programming mode.
2. Enter Program Mode by pressing the **PROG** key to enter programming mode. The display will show the last CV and CV Value you programmed.
3. Press the **PROG** key until the “Po” appears in the Mode Indicator area of the display. If you are using an untethered radio throttle, the display will automatically show Po. The DT500 display will show the address that was selected on the active throttle in the right side of the bottom line of the display. This is the address that you are preparing to program.
4. Use the **L** Throttle knob to dial up the CV you want to modify. Use the **R** Throttle knob to dial up the CV value you wish to program for the CV. This example shows CV04 set to a value of 003 for loco address 597.

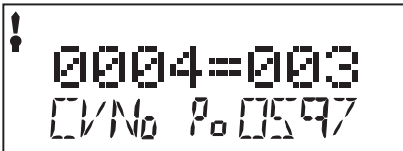

5. Press the **ENTER** key to program the selected CV value into the selected CV number. You can program as many CVs and their values as you want in a session.
6. Press the **EXIT** key to quit programming mode and return to normal operations.
7. With ops mode programming, the command station does not turn off track power. If you are using a DB150, you do not need to turn track power back on after programming with ops mode like you do with service mode programming.

16.4 Busy or Fail Message

If you get a “Busy” message in response to any programming task, the system is temporarily busy and you will have to try the task again until you get a “Good” response.

If you get a “Fail” message in response to any programming task, check to be sure that there is a loco on the programming track and that the programming track is powered.

To end a programming read back that is taking too long, simply press the **BACK** key. Note: The DB150 is not able to read back CVs.

16.5 Reading Back CV Values Programmed

Your DT500 series throttles together with a compatible command station can read back the configuration variable values programmed into your decoders.

Since you must use the programming track for this, DT500s must be plugged in to LocoNet to read back CV and their values. The DT500D can read back while not plugged in.

Systems with a DB150 command station are not able to read back CV Values programmed into decoders.

To Read back CVs:

1. Place the decoder equipped locomotive you want to program on the programming track. You can also do an ops mode read back with Digitrax transponding decoders if you have a LocoNet device that allows ops mode read back plugged in to LocoNet.
2. Enter Program Mode by pressing the **PROG** key to enter programming mode. The display will show the last CV and CV Value you programmed.
3. Select the programming mode you wish to use by pressing the PROG key until the method you want appears in the Mode Indicator.

You can read back in PG, PH, Pd, or Po modes with the following restrictions:

PG - Paged Mode no restrictions

PH - Physical Register Mode can only read CV01-CV08. You should not rely on values in the display for CVs above 08 when reading back in physical register mode.

Pd - Direct Mode no restrictions

Po - Operations Mode read back can only be used with Digitrax decoders that are capable of ops mode read back when there is a device attached to LocoNet that supports ops mode read back. Digitrax transponding decoders and DCS210 or DCS240 would allow ops mode read back.

4. To read back the CV value programmed for the *two digit address*, use the **L** Throttle knob to dial up Ad02 (CV01) on the left side of the text area and then press the **DISP** key. The text area will show Ad2 =rd followed by a flashing box. When the read back is finished, the CV value (the 2 digit address) will be displayed on the right side of the text area.
5. To read back the *four digit address* that is programmed into the decoder use the **L** Throttle knob to dial up Ad02 on the left side of the text area, then press the R throttle knob to change to Ad4. The text area of the display will show Ad4=???? (disregard any value that appears at this time). Press the **DISP** key and the display will change to Ad4=8rd followed by the flashing box. When the read back is finished the 4 digit address will be displayed on the right side of the text area.

6. To read back any other CV start at AD2=??? (Use the **L** Throttle knob to dial in Ad2 on the left side of the display or if you were in four digit addressing, press the R throttle knob once). Use the knob to dial up the CV you want to read back or use the numeric keypad to enter the CV Number. Press the **DISP** key the display will show the CV number=rd followed by the flashing box. When the read back is finished, the CV value for that CV will be displayed in the Right side of the text area.

Note: You can abort any read back in progress by pressing the **BACK** key.

7. Once you have read back any CV, you can change its value by dialing in the CV value you want and pressing the **ENTER** key.

8. Press the **EXIT** key to quit programming mode and return to normal operations (Fn Mode). You can read back and re-program as many CVs and their values as you want in a session. When you are finished, press Press the **EXIT** key to quit programming mode and return to normal operations.

17.0 How the DCS210 Manages Addresses

Your DCS210 has a finite number of “slots” available in its memory. The DCS210 has the capable of selecting 100 addresses at a time. Once the slots available in your command station are full, the system will display the “slot=max” or “FF” message to let you know that you need to release some locos if you want to select and run others. *Find details on loco dispatching in section 10.7 or you can simply press the Loco Rest Button to clear all slots in the DCS210 command station.*

17.1 Purging of addresses:

Purging is the process by which the DCS210 changes the status of decoders that are either not being used or are unattended to make room for other addresses to be selected and refreshed by the command station. *See Section 8.2 for setting the DCS210 OpSw 13,14, and 15 to manage how the DCS210 purges addresses.*

The DCS210's default setting for purging are:	
OpSw 13	t = Loco address purge time 200 seconds
OpSw 14	t = Loco address purging enabled
OpSw 15	t = Purging will not change loco speed

18.0 Decoder Status

The command station assigns status codes to each locomotive address in the system. Addresses are either selectable or not selectable. Decoders are not selectable if they are in-use on another throttle or if they are part of a consist. If you try to select an in-use address, you will be prompted to “Steal” the address. If you select a decoder that is part of a consist, you will be able to send function commands but you won’t be able to control its speed or direction. The text line in the DT500 display will show “top”, “cn” or “mid” if the address is part of a consist, otherwise it will show “stat”. This display is followed by the status code for one of the following modes of operation.

Display	Meaning
28	28 Speed Step Mode
14	14 Speed Step Mode
128	128 Speed Step Mode Digitrax Preferred Mode
28 FX	28 speed step-enable advanced consist mode
x01	Reserved, Do not use
x02	Reserved, Do not use
*128 FX	128 speed step-enable advanced consist mode

Status editing is used most often when you are running non-Digitrax decoders that do not have 128 speed step capabilities. If you can’t get a non-Digitrax decoder to work on your layout and you are sure you are using the correct address for the decoder, you probably need to status edit it to run in 14 or 28 speed step mode.

18.1 Status Editing Decoders

1. Press the **LOCO** key to enter address selection mode, the display will begin flashing the address on the active throttle and will display “Sel Loco” in the text area to prompt you to select an address. Lo will also be flashing.
2. When you use the Throttle knobs or key pad to enter the address of the locomotive you want to select, the display will show the current status of the decoder. To display the status code of the loco address that is flashing in the display when you enter selection mode, just turn the throttle knob up one address and then back to the original address and the status code will display on the Display.

- To change the status of the decoder simply press the **EDIT** key the flashing Lo will change to SE and the current status code of the address will be displayed. Use either Throttle knob to scroll through the status codes shown in the table above.

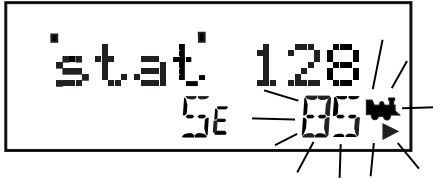

- Once the status code you want to use for the address is displayed in the text area of display, press the **ENTER** key to change the status code of the locomotive and to select it to run on the active throttle knob.
- If the loco address is in-use on another throttle or in a consist when you press the **ENTER** key to complete the status edit process and select the loco on the active throttle, the DT4xx will prompt you to Steal=Y. If you want to steal the address, press the **Y / +** key to complete the status edit. If the loco is part of a consist, it will not be selected and will remain part of the consist when the status is edited.

18.2 Note for Non-Digitrax Decoder Users

If you have a decoder that does not have advanced 28/128 speed step mode available, you must “status edit” that locomotive to standard 14 speed step mode before running it with your Digitrax system. Changing the decoder’s status will cause the system to handle this decoder as a 14 step decoder. Status editing does not reprogram anything in the decoder.

19.0 Updating the DCS210 to the latest firmware

Occasionally Digitrax makes updates and improvements to the operational code of its products. In order to update your DCS210 you will need to have a computer interface, such as a PR3 or DCS240. You will also need the DigiIPLII utility and the latest firmware (.dmf) file. The DCS210 can be updated via LocoNet using a PR3 or other computer to LocoNet interface. When updating via LocoNet the PWR indicator will flash Green alternating with the NET indicator flashing RED slow, about once a second For complete instructions and the latest firmware files visit <http://www.digitrax.com/downloads/>.

20.0 UR92 Additional Information

20.1 Advanced UR92 Installation

Adding UR92s will provide better signal coverage for complex layouts. If you are adding more than one UR92 be sure to connect all of the units to LocoNet before changing the Duplex Group name or channel number. This will prevent the units from automatically re-negotiating these values with each addition.

- Add the UR92(s) to your LocoNet. (See UR92 Installation sections 2.0 and 20.0.)

2. After adding extra UR92s, use the DT500D to turn OFF layout track power and then turn track power back ON. This forces all the UR92s to automatically negotiate a common Duplex Group name and channel number. (Your Group name may change with each UR92 addition.)
3. Rejoin the DT500Ds by either the tethered (described above) or untethered method (described in the DT500 manual) to use the newly established Duplex Group name and channel.

Setting Duplex Group Name: You can use the DT500D to edit the UR92's Duplex Group name to one you choose. This change is optional, and the UR92 factory default will work out of the box with no change. You should have all UR92s connected to the layout before changing the Duplex Group Name or they will automatically renegotiate and may change the preferred name to a default.

1. Connect the DT500D to the front RJ12 jack of any UR92 on the LocoNet.
2. On the DT500D press the **OPTN** key and then the **EDIT** key.
3. The 8 character Duplex Group name will appear in the display center.
4. Use the **R** Throttle knob to change the first character value. It will blink as it is changed. When the desired character is seen, use the **L** Throttle knob to move across and select a character to modify.
5. Press the **ENTER** key to update the current displayed characters as the new UR92 Duplex Group Name. To skip making any changes, simply press the **EXIT** key.
6. After changing the Duplex Group Name, your other DT500Ds will need to rejoin to use this new Group Name. **Note:** As long as Duplex Group Name is unique, it is generally possible to run dozens of different layouts on the same channel number in close proximity.

Setting the Duplex Group Channel: You can use this capability to move the duplex channel away from signal interference caused by other devices.

1. Connect the DT500D to the front RJ12 jack of any UR92 on LocoNet.
2. On the DT500D press the **OPTN** key and then the **EDIT** key. The Group channel number (11-26) will now show in the lower left hand side of the display.
3. Use the **Y / +** key to change to a higher channel in the available range of 11 through 26. The **N / -** key will change to a lower channel.
4. Press the **ENTER** key to update the currently displayed channel as the new UR92 channel to be used with the Duplex Group Name.
5. After changing the channel all Duplex radio throttles will have to rejoin to use this new channel. To skip making any changes, simply press the **EXIT** key.

Note: If you suspect a Wireless LAN or other device is causing interference

and limiting range, you can change the channel as above, and search through all available 16 channels to find one that gives the best coverage.

See additional resources at www.digitrax.com. There are additional utilities to let you scan the layout environment for any signals using the installed UR92's as scanners and to easily update your Duplex Group name, channel and to set up a Password to protect your Group from unauthorized access.

20.2 Troubleshooting UR92 Installation

To get the best performance from your duplex radio installation, walk around the layout and check Duplex operation for adequate signal coverage.

Depending on the layout size, geometry and surrounding materials it is often possible to move the UR92(s) to better cover dead spots. Experimenting with UR92 location will usually help you locate a position that is best for your layout. Note that DT500D orientation and body position of you and your operators may also affect the UR92's range and reception.

On very large layouts or layouts with problem areas, it is possible to add more than one UR92. Adding extra units will automatically provide space-diversity coverage and reliability. Adding multiple UR92s is covered in the Advanced Installation and Customization section of these instructions.

If duplex range is poor, it may be due to interference from a Wireless LAN or similar device operating continuously on the same channel. The next section outlines several ways to avoid interference and congestion from other devices.

20.3 Resetting UR92 To Factory Defaults

You are unlikely to encounter a problem that will require a factory reset. One such instance may occur if you set a Password for your Duplex Group Name and forget what it is. Resetting to factory default condition is an easy way to correct the situation.

1. Disconnect the UR92(s) from the LocoNet. If you have more than one UR92 in your layout, you must disconnect all of them to do a full factory reset on each unit as follows.
2. Disconnect any throttle that is plugged into the UR92.
3. Leave the PS14 power supply connected to the UR92 and to the wall outlet.
4. Press and hold the button (next to the power supply jack) for two seconds or until both the red and green LEDs begin to blink. Release the button.
5. When the lights stop blinking, unplug the power supply.
6. Reconnect the PS14 DC power supply to the UR92. The green and red LEDs will blink and then the red LED will stay on.
7. Connect the UR92 to your working LocoNet system using one of the RJ12 jacks at the rear of the UR92. The red LED will go off and the GREEN **RADIO** LED will blink at a 2-second interval to indicate that it is set up for duplex radio operation and is working.
8. The UR92 is now set to the factory default Group Name of Dtxnnnn (where "nnnn" is the unit serial number) and Channel 11.

21.0 Troubleshooting Problems

21.1 I'm lost!

If your DT4xx display isn't showing you what you expect based on the manual, press the **EXIT** key to return to normal operating mode Fn. Then try the throttle task again.

21.2 Runaway train or layout!

- Press the **PWR** key followed by the **N / -** key, OR
- Flip the MODE switch to "SLEEP" on the DCS210 Command Station.

Either way, the layout will stop to give you a chance to regain your composure.

To resume operations where you left off

- Press the **PWR** key followed by the **Y / +** key, OR
- Flip the MODE switch to "RUN" on the DCS210 Command Station.

21.3 Nothing is responding

Is track power turned on? Is your throttle in Idle or stopped and displaying a flashing TRACK POWER indicator and Trk=Idle in the throttle display?

Press the **PWR** key followed by the **N / -** key then **Y / +** key then **PWR** key to toggle the track power off then on. You should see the TRACK POWER indicator on the DT4xx come on solid.

21.4 Can't select a loco on my throttle

Is the loco in use by another throttle

Did the throttle ask you "STEAL=Y?".

Is the loco part of a consist?

Do you see a cn in the display when you try to select it? A loco in a consist cannot be selected and run separately. You can still control some Functions.

Have you changed the loco address?

You can read back the loco address to see if it has been changed. *See your throttle manual for instructions on reading back loco addresses.*

Does your throttle say "slot=max"?

This means that the system's capacity to handle operating locos is full. The DCS210 default setting can run up to 400 addresses at the same time. If you have the "slot=max" message, be sure that all locos that are not running are released from throttles. All locos can be cleared from the system by pressing the LOCO RESET button.

21.5 Clean Track

The majority of intermittent operation problems can be traced to bad connections and poor or noisy wheel pickups on locomotives. Check track cleanliness and quality of wheel pickups.

21.6 The Quarter Trick

If your track does not have adequate power supply to the locomotives, then the signal won't get through either. Take a quarter or screwdriver blade and go around your layout creating electrical shorts every 10 feet. Your DCS210 should beep 4 times and shutdown when the short is present. When the short is removed, the booster should beep once within 2-3 seconds and return to normal operation. If this does not happen, then you need to add more feeders. *See Section 6.4.*

21.7 The LT1 Tester

Check your LocoNet cables with the LT1 tester to be sure you don't have any cables that were made incorrectly. *See Section 5.8.*

21.8 Decoder Won't Respond Is the loco on powered track?

If the TRACK POWER indicator on the DT4xx is off or flashing, press **PWR** key and the **Y / +** key to turn on track power.

Use the "Quarter Trick" above to test for track power at several locations around the loco. If there is not track power, check your layout wiring.

Can you select the loco on your throttle?

If not, is the loco in use by another throttle or is it part of a consist (do you see a cn in the display when you try to select it)?

Do the settings in CV29, the configuration register, match the command station output?

If your decoder is a 14-step decoder running on any Digitrax system using factory defaults, status editing will be needed for that decoder. *See Section 18.1.*

Have you reset any CVs since the last time you ran the loco

If so, go back and change them to their default CV values and then try to run the loco. It is possible to set acceleration so high that it will take 10 minutes for the loco to start moving. To reset to factory default, see the Decoder Manual for a full listing of CVs.

Was the loco running just before it stopped?

If the decoder is very warm it may be in thermal shutdown. Let it cool off and see if it starts again. Also check for localized track problems. See Quarter Trick on previous page.

Are there burn marks on the decoder?

You'll need to send it in for repair!

If all else fails, reprogram the decoder address and reset CVs to default values.

21.9 "Strange" Locomotive Lights

If you can't control the operation of the lights in your locomotive with the DT4xx (in default 128, or 28 speed step mode), be sure that the decoder is programmed in advanced 28 speed step mode.

Do this by programming CV29 with a value of 06. See your Decoder Manual for more information about programming decoders.

Glossary

128 Speed Step Mode: the motor voltage/speed curve of the decoder equipped loco from stop to full speed has 128 discrete speed steps. This means that you have 128 discrete speed steps at your disposal for excellent speed control, especially at very low speeds. 128 speed step operation will give a significant improvement in speed control over 14 or 28 step operation.

2-Digit Address: decoder address between 01 and 127 which is expressed as a 2 digit number. Addresses above 99 are expressed as hexadecimal numbers. The DT4xx translates these numbers into three digit numbers 100-127. Technically a 2 digit address is a 7 bit address and is the baseline packet format for DCC addresses. It is sometimes called the short address.

4-Digit Address: decoder address between 0128 and 9983. Not all 4 digit addresses in this range are actually available for use. Your DT4xx can access 0128 through 9983. Digitrax handles addresses below 0128 as two digit addresses to avoid confusion. Technically a 4 digit address is a 14 bit address and is considered an extended packet format DCC decoder address. Sometimes this is called the long address.

+: plus or add, used to increase speed or other numbers in DT4xx display. Also used to add loco addresses to consists.

-: minus or remove, used to decrease speed or other numbers in the DT4xx display. Also used to remove loco addresses from consists.

AC or Alternating Current: An expression used to describe an electrical wave form that cycles or alternates above and below 0 volts. In the U.S., household electricity is 60 cycle, alternating 60 times a second, 110-120 volts.

Acceleration: The rate at which the decoder increases from one speed step to the next in response to a new increase speed command. Use CV03 to set this value for each decoder. This feature is used to simulate train weight and to cause your model to respond more prototypically when you increase the throttle.

Active throttle: Digitrax DT throttles are actually two throttles in one. Each hand held can control two different addresses or consists at a time one on the right side or R Throttle and the other on the left side or L Throttle. The DTs display is shared by the two sides of the throttle. The side for which information is currently in the display is called the active throttle.

Address, Decoder: an identifying number programmed into a particular mobile or stationary decoder. The system uses the decoder address to send commands to the appropriate loco or accessory decoder.

Address Range: Analog address range is 00. 2 digit address range is 01-127, 4 digit address range is 0128-9983.

Advanced (EPF) Consisting Method: consist information is stored in each decoder. Locos can be added to and deleted from the consist in any orientation. This method requires that all locomotives in the consist be equipped with decoders that support this feature (EPF decoders). This method lets you set up a consist that is “transportable” from one layout to another. The problem is that you must be sure to put the locos back on the track in the same order and orientation you programmed them for or you can get some unexpected results.

Advanced Mode (28 Speed Step Mode): the motor voltage/speed curve of the DCC loco from stop to full speed has 28 discrete speed steps. This means that speed control will be limited to 28 steps. 28 speed step mode gives fine speed control. Increasing to 128 speed step operation will give a significant improvement in speed control, especially at very slow speeds needed for prototypical switching operations. Advanced mode is offered in most command stations because there are decoders on the market that are not capable of 128 step mode operation.

Analog Loco: A locomotive operating on a DCC layout without a DCC decoder installed. Also called a Conventional Loco.

Analog Mode Conversion: When a Digitrax decoder does not see DCC packets on the layout it changes automatically to DC operation. Not all DCC systems support this feature so you may have to program non-Digitrax decoders to operate on analog layouts. Automatic analog mode conversion can be disabled by programming CV29.

Autoreversing: a feature of Digitrax boosters that allows a train to enter and exit reversing sections automatically without the need for the operator to throw a switch to match track polarities on either side of the reversing section.

Ballast Lamp: For use as a buffer between DC and DCC track sections, a ballast lamp is connected across one of the double gaps separating the two track sections. For most model railroad applications a 12 volt automobile brake lamp wired in series is used for this purpose.

Basic Consisting Method: Program all the locomotives in a consist to the same address and run them on one throttle. In this case all the locos must be running in the same direction unless you have set up normal direction of travel as reverse or have rewired the motor on locos that you want to run “backwards” in the consist.

Booster: Boosters receive the control signal from the Command Station, amplify it and put it on the track as the power that runs the locos. You can have several boosters on a system, each driving its own track section. You can have both regular or auto reversing boosters depending on your needs. Also called Power Booster, Power Station.

Browsing: scanning sequentially through locomotive or accessory decoder addresses and statuses in you throttle. Browsing is done with the DT4xx by turning the throttle knobs or using the Y+ or N- Keys.

c: closed, indicates that the turnout is in the straight through position, set for the mainline. For op switch set ups, consult your manual for the meaning of c and t.

Cab: See Throttle.

Command Station: Most systems have one Command Station that generates the commands that are sent to the decoders. The command station also produces Rail Sync so that all the devices on your LocoNet work together.

Common (Loco Status): a locomotive that is not currently “in-use” by a throttle connected to LocoNet but is still being refreshed by the command station. A loco with a status of “common” is selectable by any throttle on LocoNet.

Common Rail Wiring: A wiring system in which one side of all the track power supplies are connected. The common rail concept simplified block wiring in conventional DC systems, but is not recommended for DCC wiring. (see Direct Home Wiring).

Compatibility: the ability of equipment made by various companies to operate together on the same layout. DCC compatibility extends to decoders and boosters but not to throttles, command stations, system architecture and advanced features that are not DCC related.

Complete Train Control: the integration of many technologies including DCC for total layout control. Since DCC covers only limited aspects of layout control, the hybrid Digitrax Complete Train Control goes beyond the basics of DCC to provide you with a total layout control system.

Configuration Register (CV29): this special CV controls several different decoder characteristics including:

1. Whether the decoder uses standard 14 speed step mode or advanced 28/128 speed step mode
2. Whether or not the decoder will automatically convert to DC operation when no DCC signal is present.
3. In the case of Digitrax FX decoders, the normal direction of locomotive travel
4. Whether the decoder uses loadable speed tables and
5. Whether the decoder uses the 2 digit address or the 4 digit address.

Configuration Variables (CVs): these are special storage locations or “pigeonholes” in your decoders. By programming values into various CVs, you can control each decoder’s performance characteristics. CVs store information like the decoder’s address, start voltage, mid-point voltage, loadable speed tables and many more. Once you have programmed these characteristics, the decoders “remember” them until you change them again. The NMRA Standard and RPs define the usage of many CVs while others are defined by manufacturers.

Conformance Seal: issued by the NMRA after a product has passed the tests established and administered by NMRA volunteers to “prove” that a particular product follows exactly to the letter the Standards and RPs set up by the NMRA that pertain to that product. Conformance seals do not insure interoperability or the quality of the products, only manufacturers provide warranties on the equipment they sell.

Consisting: linking more than one locomotive together to be controlled by a single throttle and or address. Also called multiple unit operation, MU’ing, multiple unit lash ups, etc.

Constant Brightness Lighting: because DCC runs with constant track voltage, locomotive lights stay on even when the loco is not moving, just like the prototype.

Conventional Loco: A locomotive operating on a DCC layout without a DCC decoder installed. Also called an Analog Loco.

DCC: Digital Command Control.

DC or Direct Current: An expression used to describe an electrical wave form in which the voltage remains more or less at a value above or below 0 volts. DC is used by most model railroad locomotives. Sometimes referred to as Analog.

Deceleration: The rate at which the decoder decreases from one speed step to the next in response to a new decrease speed command. Use CV04 to program the deceleration value for each decoder. This feature is used to simulate train momentum so that, just like the prototype, your model won't stop immediately when the brakes are applied.

Decoders, Mobile: the electronic device installed in each locomotive that receives the signal from the command station through the track, decodes it and tells the loco what to do. Mobile decoders can also include function control, speed stabilization (back emf), transponding and other features.

Decoders, Stationary (Accessory or turnout): the electronic device for the turnouts or other accessories that receives the signal from the command station through the track, decodes it and tells the turnout/accessory what to do.

Decoder Status: the Digitrax command station assigns each decoder a status based on whether it is new to the system, in-use on a throttle, common in the system and available for selection or idle. The decoder status determines how the system treats that address.

Direct Home Wiring: A wiring system in which the DCC booster powers each rail through an individual conductor or wire. Each booster is wired to its own power district and there is no common connection between boosters. Digitrax strongly recommends direct home wiring.

Direct Programming: A type of service mode programming.

Directional Lighting: loco lights can be set up to automatically change so that the forward lamp is lit when the loco is moving forward and the reverse lamp is lit when moving in reverse.

Dispatching: use your DT throttle to set up a loco or consist you want to be run by another operator and then using a couple of keystrokes, dispatch the loco from the DT throttle and acquire it on the other throttle.

Duplex Transceiver. two way radio operation allows a duplex equipped throttle to send and receive information to the command station via a radio transceiver while not plugged in to the LocoNet.

EPF or Extended Packet Format: an extension of the baseline DCC format that allows us to use four digit addressing and other expanded decoder features.

Fn: Shorthand for Function

F0: Shorthand for Function 0. F0 is two functions in one. F0 Forward controls the white function lead and F0 Reverse controls the yellow function lead. Digitrax ships all decoders set up for automatically reversing head/tail lights using F0 Fwd and F0 Rev. These can be programmed to operate separately and be controlled by the operator if you do not want automatic operation.

F1: F1 is usually used to operate the bell if sound is being used.

F2: F2 is a special key set up to act as a momentary function key. When you press F2 the function will remain active for as long as you hold the key down. This momentary feature is important if you are using a whistle or horn. F2 can also be latched on if you are not using it for a horn.

F3-F28: these are regular on/off function keys. F3 and F4 can be turned on and off by pressing them after the FN F0 Key is pressed and you are in function mode. F7 and F8 can be accessed by pressing and holding the FN F0 Key (use this key as a “shift” key) and then pressing the F3/F7 or F4/F8 Key.

Fast clock: used by many operators during operating sessions to simulate prototypical operations. Traditionally, the fast clock is on the wall and is set up to run at a faster than normal time so that you can “get in a full day’s work on the railroad in a fraction of the time.”

Functions, Decoder: function leads are extra decoder wires that you can connect to any device on the loco that you want to control from the hand held or other input device such as a computer. These can be used for locomotive lighting, sound units, smoke units, and other locomotive animation tasks.

FX Functions: specially designed functions (available on Digitrax FX and FX³ series decoders) that let you set up lights on your loco to simulate Mars lights, Gyra lights, ditch lights, rotating beacons, single or double pulse strobes, flashing lights, random firebox flicker and more. CVs 49-63 are used to set up these special light effects.

Idle (Loco Status): a locomotive that has been addressed by the system previously, is currently selectable by a throttle on LocoNet, and is not being refreshed.

In-Use (Loco Status): a locomotive that is currently selected on a throttle connected to LocoNet. An in-use loco is having its data refreshed by the command station and is not selectable by other throttles on LocoNet. The exception to this is if a throttle “steals” an in-use loco

L: Left throttle, Left reverse key, Left side of DT4xx display

Loadable Speed Table: use CV65 through CV95 to enter a value for each discrete speed step in a 28 speed step curve. This feature allows you to customize a loco's performance curve and makes speed matching of locomotives possible. With this feature you can limit the top speed of a loco. Once you have programmed CV65 through CV95 to set up the table, you will also need to set up CV29 to enable it. This allows you to enable and disable the table at will and to keep the table stored even when it is not in use. Digitrax FX and 4th generation decoders go one step further and give you 128 speed step resolution with loadable speed tables

Mid-Point Voltage: the value programmed into CV06 specifies the voltage to apply to the motor at speed step 15 in a 28/128 step system and step 7 in a 14 speed step system. This allows you to make a quick adjustment to the motor voltage/speed curve without setting up a loadable speed table.

MU: Multiple unit operations. See Consisting.

N: No, use the **N / -** key to respond to DT400/DT4xx series throttle text messages.

New (Loco Status): a locomotive that has not been addressed by the system. A new loco is selectable by throttles on LocoNet and is not refreshed.

Operating Mode: 14 or 28/128 speed steps. See also, Speed Steps, Standard Mode, Advanced Mode and 128 Speed Step Mode.

Operations (OPS) Mode Programming: lets you program CVs in DCC locos equipped with EPF decoders while they are on the mainline. A typical use for ops mode programming would be to change the acceleration rate (CV03) or the deceleration rate (CV04) of your locos to simulate the weight and braking characteristics of the train to compensate for changing the number of cars and power units in the train.

Paged Programming: Digitrax preferred method of service mode programming.

Physical Register Programming: A primitive type of service mode programming. This method is limited to programming 2 digit address, acceleration, deceleration and start voltage.

Power Booster: See Booster

Power District and Power Sub-district: A power district is the power wiring, components and equipment attached to that wiring, driven by a single properly isolated booster. A power sub-district is a sub-division of a power district.

Power Station: See Booster

Power Supply: a transformer that provides power to the layout control system.

Programming: entering values into configuration variables (CVs) available in DCC decoders or option settings for the throttle or command stations.

Programming Track: an electrically isolated track section used for decoder programming. This track ensures that broadcast programming instructions are only sent to the decoders you want to program.

Purging: the process by which Digitrax command stations automatically release locomotives from “in-use” to “common” when they are not selected on a throttle connected to LocoNet. This makes locos that have been “forgotten” by their operators available to be selected by other operators to prevent problems during an operating session.

PWM: Pulse Width Modulation.

R: Right throttle, Right reverse key, Right side of DT4xx display.

Recall stack: List of previously selected addresses stored in the DT4xx Throttle.

Refreshed (Data): Digitrax command stations re-send data to decoders many times to be sure that the signal is not lost and that you have reliable operation. All in-use and common locos in the system will continue to be refreshed until they become idle.

Route: a group of turnouts and their specified positions that will be triggered by the activation of a single “TOP” switch address to a specified position.

Scaleable Speed Stabilization (back EMF): a decoder that uses back EMF to maintain constant speed but can also buffer the speed changes to allow for optimal operation. A speed stabilized decoder that is not scaleable will cause a locomotive to maintain the speed you set no matter what grade the loco encounters. It’s like “cruise control for your loco.” If speed stabilization is not scaleable, you can have the pushy pusher problem if you run consists.

Select: To assign a decoder address to a throttle in the system so that the address can be controlled by that throttle.

Selectable: a DCC decoder is selectable when it is not currently in-use on another throttle.

Service Mode Programming: service mode programming information sent by the command station or programmer as a broadcast signal that goes out to all decoders on the track.

Slot Following: when more than one DT throttle has a single loco address selected, both DT throttles will have control of that address and both throttle displays will be updated with the same information. In other words, both operators will see what the other is doing.

Speed Steps: because DCC is a digital system, locomotive speeds are defined as discrete speed steps. This means that as motor voltage is increased, the speed of the locomotive increases in a straight line from stop to full speed with discrete speed values at each voltage.

Split field Motor: Another term for AC motor

Standard Mode (14 Speed Step Mode): the motor voltage/speed curve of the DCC loco from stop to full speed has 14 discrete speed steps. This means that speed control will be limited to just 14 steps. 14 speed step mode gives reasonably good speed control. Increasing to 28 speed step operation will give much better speed control and going to 128 speed step operation will give really excellent speed control. Standard mode is offered in many command stations because there are some decoders on the market that are not capable of 28 or 128 step mode.

Start Voltage (V-start): the voltage added to the motor drive voltage at the first speed step. This adjustment allows you to trim the loco to compensate for its motor efficiency.

Status Editing Decoders: a DCC decoder's status can be manually changed by a Digitrax command station at any time the decoder is selectable.

Stealing a Loco: overriding the in-use interlock and forcing the throttle to select an in-use loco. This can result in having two throttles logged on to and controlling one address. See also Slot Following.

t: thrown indicates that the turnout is set for the diverging route. For op switch set ups, consult your manual for the meaning of c and t.

Throttles: Throttles are input devices that tell the Command Station what you want the decoders to do. You can have many throttles on your system. The number is determined by the capabilities of the Command Station you are using. You can also use a computer to create "soft" throttles. Sometimes throttles are also called "Cabs."

TOP Locomotive: Digitrax calls the locomotive that other locomotives are consisted to, the TOP locomotive because it is not necessarily the lead loco in the consist. The TOP locomotive address controls the speed and direction of all locomotives consisted to it.

Transponding: The use of transponders installed in rolling stock and transponder detectors installed in the layout to allow the system to determine the location of a particular piece of rolling stock on the layout. Other information about the rolling stock such as speed, direction, etc. can also be determined. Transponding is useful for automation of staging yards, dispatching and for realistic sound systems.

Universal Consisting: the command station handles all consist information and lets you consist locos with any DCC decoder as well as analog locos. The locos can be added to and deleted from the consist in any orientation head to head or tail to tail.

Y: Yes use the Y / + key to answer questions in the DT500 text message display.

Zero-Stretching: incorporates a time period between packets to give you an effective DC offset between the two rails. This allows you to control a DC locomotive along with the DCC locomotives on a DCC system.

FCC Information

Radio or TV Interference: (this information is MANDATED by the FCC) This equipment has been tested and found to comply with the limits for a Class B digital device, pursuant to part 15 of the FCC rules. These limits are designed to provide reasonable protection against harmful interference in a residential environment. This equipment generates, uses and can radiate radio frequency energy and, if not installed and used in accordance with the instruction manual, may cause harmful interference to radio communications. However, there is no guarantee that interference will not occur in a particular installation. If this equipment does cause harmful interference to radio or television reception, which can be determined by turning the equipment off and on, the user is encouraged to try to correct the interference by one or more of the following measure

- Reorient or relocate the receiving antenna.
- Increase the separation between the equipment and the receiver.
- Connect the equipment into an outlet on a circuit different from that to which the receiver is connected.
- Consult the dealer or an experienced radio/TV technician for help.

Note that any modifications to the equipment not expressly approved by Digitrax voids the user's authority to operate under and be in compliance with CFR 47 rules, as administered by the Federal Communication Commission. Digitrax believes any conscientiously installed equipment following guidelines in this manual would be unlikely to experience RFI problems.

For Canadian Users:

“This digital apparatus does not exceed the Class B limits for Radio noise emission from digital apparatus set out in the Radio Interference Regulation or the Canadian Department of Communications.”

Le present appareil numerique n emet pas de bruits radio-electriques depassant les limites applicables aux appareils numeriques de la classe B prescrites dans le Reglement sur le brouillage radioelectrique edicte par le ministere des Communications du Canada.

Patents and Trade Secret

Digitrax uses material covered by US Patents 6,220,552, 6,275,739, 6,318,678, 6,367,742, 6,545,886, 6,513,763, 6,747,579, 6,536,716, 6,533,223, 6,533,224, 8,229,582, 8,292,237, 6,729,584 and others under non-exclusive licenses and/or assignments from Anthony J. Ireland. Licensing for material covered by these patents are available to other companies and individuals. Other patents covering technology used by Digitrax are pending. Measures to protect trade secret information are enforced.

Digitrax licenses the commercial use of LocoNet, which is trade secret technology, to other companies on a non-exclusive basis. LocoNet is copyrighted property.

Warranty and Repair Information



Digitrax gives a one-year “no worries” warranty against manufacturing defects and accidental customer damage on all Digitrax products. That’s it! Simple, straightforward warranty, no tricky language!

All warranties on Digitrax products are limited to repair or replacement of Digitrax products at the discretion of Digitrax. Except to the extent expressly stated, there are no warranties, express or implied, including but not limited to any warranties of merchantability or fitness for a particular purpose.

For items that are no longer covered under warranty, whenever possible we will make repairs to units at fair and reasonable rates.

Please visit our warranty and repair page at www.digitrax.com/warranty for warranty and repair information and procedures.

Digitrax, Inc. reserves the right to make changes in design and specifications, and/or to make additions or improvements in its products without imposing any obligations upon itself to install these changes, additions or improvements on products previously manufactured.

Digitrax, Inc. is not responsible for unintentional errors or omissions in this document.

Index

Symbols

2 digit addressing 101
4 digit addressing 101
.dmf 108
(PROG) Indicator 36

A

A / 10 60
acceleration 103, 112, 119
Address 00 38
Advanced Consisting 83
analog locomotive 9
AR1 33
Automatic reversing 24

B

B / 11 60
BACK key 14, 58, 59, 63, 91, 106
backlight 12, 98
ballistic tracking 51, 58, 77, 97
bar graph 54, 67, 69, 85
Basic Consisting 83, 114
battery 10, 12, 13, 62, 70, 76, 78, 80
beeps 33, 35, 39, 41, 48, 89
Bell / 1 key 60
blinking smoke 14, 20, 52, 56, 60, 63, 66, 104
boosters 23, 24, 29, 30, 31, 32, 33, 34, 43, 115, 117
Busy or Fail Message 104

C

C / 12 60
Cab Signaling 56
change a LocoNet ID 79
Clean Track 111
CLOC / c 43, 44, 87, 91
closed 43, 89, 91, 115
Command Station collision detection 33
Common (Loco Status) 115
Common Rail Wiring 30, 115
computer 24
Configuration Variables (CVs) 99, 116

consist 55, 57, 67, 68, 75, 76, 83, 84, 85, 107, 108, 111, 112, 114, 117, 121, 122
Control Panel 35
Coupler / 3 key 60

D

DB150 32
DB200+ 32
DCC addresses 113
deceleration 72, 103, 117, 119
Decoder Status 107, 117
Decoder Won't Respond 112
Direct Home Wiring 30, 115, 117
direction 9, 14, 16, 17, 18, 19, 20, 33, 51, 52, 57, 63, 64, 65, 66, 67, 69, 70, 75, 83,
84, 85, 86, 107, 114, 116, 121, 122
direction indicator 52
Direct Mode 105
dispatch 20, 67, 68, 117
Dispatching 117
dispatching loco addresses 58
DISP key 58, 59, 67, 68, 92, 105, 106
display 9, 10, 12, 13, 14, 16, 17, 18, 19, 44, 51, 53, 56, 60, 62, 63, 64, 65, 66, 67,
68, 69, 70, 71, 72, 73, 74, 75, 77, 78, 79, 80, 81, 82, 84, 86, 87, 88, 90, 91,
92, 94, 95, 96, 97, 100, 101, 102, 103, 104, 105, 106, 107, 108, 109, 111,
112, 113, 118, 120, 122
display backlight 12
diverging route 59, 86, 121
double click 17, 18, 19, 64, 65, 66
Duplex Group 10, 11, 13, 62, 80, 81, 82, 108, 109, 110
Duplex Group Channel 80, 82, 109
Duplex Group Name 80, 109, 110
Duplex radio 98, 99, 109
duplex radio issues 11
Duplex Radio transceiver 10

E

Easy Routes 40, 89, 90
EDIT key 58, 79, 81, 82, 87, 88, 90, 108, 109
EMRG STOP key 60, 72
ENTER key 10, 60, 79, 91, 101, 103, 104, 106, 108, 109
event driven network 23
EXIT key 14, 18, 53, 60, 63, 64, 67, 78, 81, 82, 86, 88, 91, 94, 101, 103, 104, 106,
109, 111
EZ Routes 41, 42
EZ RTS 38, 40, 89

F

Fast Clock 87
feeder wires 31
FIND key 58, 95
firmware 1, 42, 108
flashlight 11, 59, 98
FUNC key 57, 73, 74, 75, 86
function 12, 16, 40, 51, 52, 53, 56, 57, 60, 71, 73, 74, 75, 77, 84, 97, 107, 117, 118
Function Display 56
Function Mode 16
functions 14, 16, 20, 40, 51, 53, 55, 56, 60, 63, 66, 71, 73, 74, 75, 78, 84, 87, 118

G

Ground 26, 31, 36, 38

H

Heat Dissipation 39
Horn / 2 key 60, 73

I

InfraReady 76
infrared 2, 10, 27, 56, 61, 76, 77, 78, 79, 99
Infrared Emitters 61
Input Mode 57, 59, 94

L

LAMP / 0 key 73
L and R Reverse Keys 57
layout wiring 2, 33, 34, 112
LCD 51, 52, 53, 54, 56, 60, 67
Liquid Crystal Display 52
local area network 23
Local Stop 72
Loco Icon 52, 53
LOCO key 17, 18, 19, 57, 64, 65, 67, 68, 69, 70, 75, 76, 107
LocoNet 2, 8, 9, 10, 11, 12, 13, 20, 21, 22, 23, 24, 26, 27, 28, 29, 32, 33, 34, 35, 37,
40, 41, 42, 43, 47, 48, 55, 56, 61, 62, 67, 68, 70, 71, 76, 77, 78, 79, 83, 85,
86, 87, 89, 92, 93, 96, 97, 99, 105, 108, 109, 110, 112, 115, 117, 118, 119,
120, 123
LocoNet cables 26, 27, 29, 34, 112
LocoNet Cables 26, 27
LocoNet connection jacks 27

LocoNet Connection Jacks 27
LocoNet ID 10, 55, 78, 79
LocoNet wiring 23, 26
LOCO RESET 38, 40, 111
Loco Reset Button 41, 48
L / Reverse key 9, 19, 20, 57, 59, 66, 71

M

main line 59
mainline route 86
Manages Addresses 106
mechanical detent 51
mechanical problems 34
Mode Indicator 53, 54, 79, 90, 102, 104, 105
Mode Switch 38
MU key 57, 84, 85
Multiple Unit 76, 83
Multiple Unit Operations 76, 83

N

Nested Consisting 85
Network Speed 24
N / - key 9, 17, 20, 56, 58, 59, 63, 67, 84, 85, 109, 111, 119
non-Digitrax decoder 107
No tetherless release allowed 76
numeric keypad 16, 19, 53, 57, 65, 73, 74, 75, 86, 106

O

Operations mode 29
Ops mode programming 29
option settings 34, 96, 120
option switch 40, 43, 44, 55, 86
Option Switch Tables 45
OPTN / t key 43, 59, 86, 91

P

Paged 55, 100, 105, 119
Peer to Peer 23
Physical Register 119
Physical register mode 100
PM42 32, 33
polled buses 23
power districts 29, 30, 31, 32, 33, 39

Power In 35, 119
power manager 24
power save 12, 14, 60, 63, 78, 98
Power Sub-district 119
Power Supply 120
PROG indicator 36, 38, 43, 89
PROG key 58, 100, 101, 102, 104, 105
Program A(PA) 30, 36
Program B(PB) 30
programming 29, 30, 36, 45, 49, 51, 53, 55, 58, 60, 77, 85, 87, 93, 94, 99, 100,
101, 102, 103, 104, 105, 106, 112, 114, 116, 117, 119, 120
Programming CVs Other Than Addresses 102
Programming Mobile Decoder Addresses 100
Programming Track 29, 30, 120
purging 46, 106
PWR key 9, 12, 13, 14, 17, 20, 21, 56, 57, 58, 59, 62, 63, 71, 72, 92, 94, 102, 103,
111, 112

Q

Quarter Trick 111, 112
Query Mode 58, 92

R

radio operation 10, 80, 110, 117
RAIL A(RA) 30
RAIL B(RB) 30
Reading Back CV Values 104
recall 51, 68, 69
recall stack 51, 68
Releasing An Address 67, 76
resume operations 71, 111
Resuming your session 21
Reverse key 9, 19, 20, 57, 59, 66, 71
Reverse / R key 9, 18, 20, 57, 59, 64, 66, 94
reversing sections 30, 33, 114
Route echo 47
Route ID 41, 89, 90
Routes 40, 41, 42, 87, 88, 89, 90, 91
run 9, 21, 24, 29, 32, 33, 34, 36, 39, 43, 47, 87, 106, 107, 108, 111, 112, 114, 117,
120

S

Safe Operation Mode 36, 39, 42
Safety Selection 76

- SCALE switch 9
- SEL 9, 17, 19, 52, 53, 64, 65, 67
- Select Address 38
- select a loco 69, 111
- Semaphores 56
- Service mode programming 30
- short circuit 31, 33, 41, 46
- shutdowns 39
- Shutting Down 16, 20
- SLEEP 20, 40, 42, 44, 111
- Slot Following 121
- slot=max 71, 106, 111
- Slot Zero 40, 48, 57, 59, 71
- smoke icon 14, 52, 63, 95
- software 23
- speed control 16, 51, 69, 113, 114, 121
- speed step 21, 107, 108, 112, 113, 114, 116, 117, 119, 121
- speed tables 116, 119
- status edit 21, 107, 108
- stealing 69, 70
- StealZap 69, 70
- Stop the Fast Clock 87
- straight line tracking 51, 58
- “Strange” Locomotive Lights 112
- Sub-district 119
- SWCH key 43, 57, 85, 91
- switch commands 41, 43, 47, 88
- Switch Mode 42, 43, 77
- Sw (Switch) mode 43, 88
- system architecture 23, 115

T

- Testing LocoNet Cables 27
- tetherless indicator 56, 78
- Tetherless Operation 76
- text area 43, 87, 90, 91, 107, 108
- throttle 9, 21, 23, 24, 27, 38, 43, 44, 87, 88, 89, 91, 107, 108, 111, 112, 113, 114, 115, 116, 117, 119, 120, 121
- Throttle Display 53
- Throttle knobs 88, 91, 107
- throttle type 13, 62
- thrown 43, 88, 89, 91, 121
- TOP address 88, 89, 91
- TOP loco 83, 84

track power 20, 21, 29, 33, 35, 41, 47, 111, 112, 115
track power indicator 111, 112
TRACK STATUS 9, 17, 18, 19, 20, 21, 27, 28, 29, 37, 42, 63, 64, 65
TRACK STATUS LED 9
Track Wiring 31
transformer 120
transponding 23, 117
Troubleshooting 33, 39, 111
typematic 58

U

UniVersal Consisting 83

V

Voltage Trim 37, 38, 41, 48

W

Walkaround Operation 1
wire sizes 31
Wiring 26, 30, 31, 33, 115, 117

Y

Y / + key 9, 17, 21, 56, 57, 59, 63, 67, 77, 82, 84, 102, 103, 108, 109, 111, 112, 122

Z

Zero Speed 72