



SDXH166D SoundFX®

Fits many HO locomotives

8 Selectable Steam & Diesel Sound Schemes Included

HO Scale

Mobile Decoder with SoundFX
Digitrax Easy Connect 9 Pin Harness
1.0 Amp/2 Amps Peak
6 FX³ Functions, 200ma output
8 Ohm 16 x 26 x 9mm Box Speaker
330uF Capacitor

Features:

- **Digitrax SoundFX® Sound System**
Your locomotives will sound in scale like the real thing with SoundFX Customizable 16, 12 or 8 Bit Sound
Works with SoundFX 8 and 16 Bit sound projects
4 Simultaneous voices
Downloadable Sound with Digitrax PR3 and SoundLoader 2.0 software
16 Megabit On board Sound Memory
1 Watt Sound Output
Cam input-synchronized steam-chuff option for steam locos
Scaleable Speed Stabilization(BEMF) optimized for sound operation
- SoundFX does not require an external rate sensor to vary workload.
- Factory 8 Ohm 16 x 26 x 9 mm box speaker on 10 Pin Plug design makes installation quick and easy.
- Smart Power Management-no more booster or programmer shutdowns!
- Program CVs using any Digitrax Compatible Control system without having to buy any extra equipment.
- Digitrax Easy Connect 9 Pin Plug for Track, Motor and Function Control.
- Series 6 Decoder Features.
- Works with PX112-10 Power Extender.
- Digitrax FX³ Functions-Control lights and functions for prototypical lighting effects and on/off control.
- Configurable FX³ Pulse Function available on all function outputs.
- Digitrax LocoMotion® System – Lets your trains run like the real thing!
- 2 Digit and 4 Digit Addressing.
- Basic, Advanced & UniVersal Consisting.
- SuperSonic motor drive for silent operation.
- Direct mode programming.
- Decoder Reset CV with or without speed table reset.
- Transponder Equipped ready for transponding on your Layout.
- Motor Isolation Protection helps prevent damage to your decoder.
- DCC Compatible.
- FCC Part 15, Class B RFI compliant.
- Digitrax “No Worries” Warranty.

Parts List

- 1 SDXH166D Function Decoder with SoundFX®
- 1 Instruction Sheet
- 1 10 Pin Sound Harness - 8 Ω 16 x 26 x 9 mm box speaker and 330uF cap
- 1 9 Pin Digitrax easy connect Track, Motor, and Function Harness

Installation Information

See the Digitrax Decoder Manual for complete decoder test procedures, installation instructions, programming and technical information. Digitrax manuals and instructions are updated periodically. Please visit www.digitrax.com for the latest versions, technical updates and additional locomotive-specific installation instructions. **CAUTION: Programming and layout track must not exceed 16V when using this decoder.**

Installation Instructions

Figure 1: SDXH166D Decoder Connections

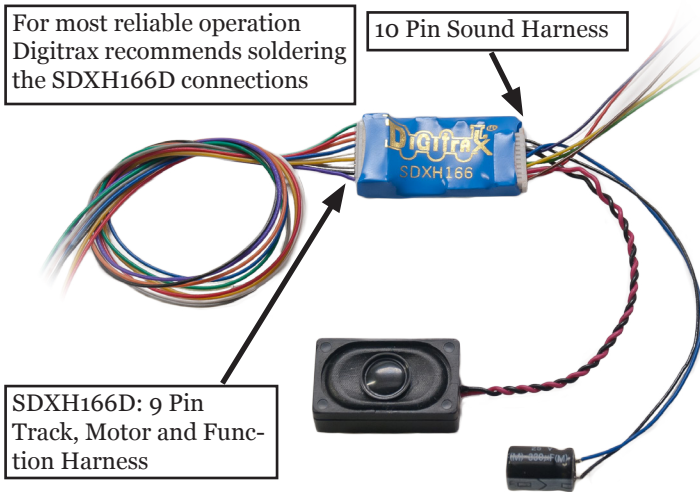

SDXH166D showing 10 Pin Sound Harness with 8 Ohm 16 x 26 x 9mm box speaker and 330uF capacitor

1. On the 9 Pin Track, Motor and Function Harness solder the Red and Black track leads to the locomotive track power connections. Next solder the Orange and Gray motor leads to the isolated motor connections. Motor connections must be isolated from the track connections. Note that to be able to read back SoundFX CVs either a motor load must be connected to the Orange and Gray leads or a combination of function loads of at least 60mA at 12volts must be connected to the function leads.

2. On the 9 Pin Track and Function Harness connect the function leads that are to be used for e.g. lights. Insulate any unused function leads so they cannot short to the locomotive frame or track power.
3. Mount the factory 8 ohm box 16 x 26 x 9mm speaker attached to the 10 Pin Sound Harness in a suitable location (refer to **Figure 2**). Be sure to inspect the speaker diaphragm for magnetic debris or damage, which will affect sound quality. Other speaker(s) may be substituted in combinations as long as the total impedance between Pin 3 and Pin 8 of the 10 Pin Sound Harness is 8 ohms or greater.

Depending on the locomotive model and construction it may be necessary to modify the frame or parts of the internal shell to make room for one or more speakers and enclosures.

Figure 2: SDXH166D: Install example in Athearn SD-70MAC with 9-Pin plug

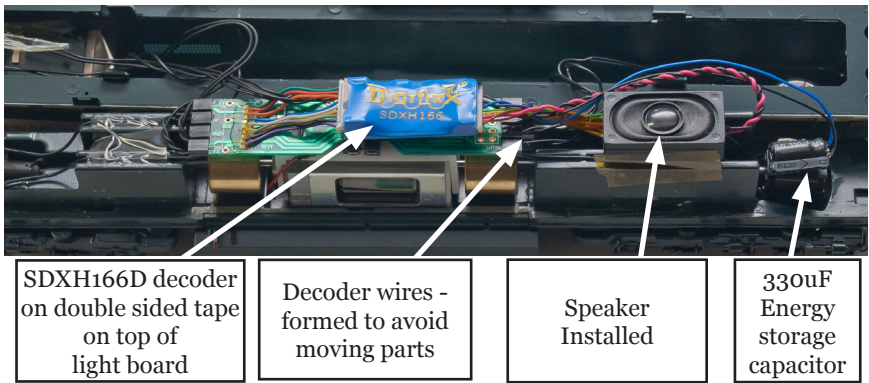

4. Mount the 330uF electrolytic energy storage capacitor from the 10 Pin Sound Harness. Be sure not to short the capacitor case or leads to the track leads or locomotive frame or damage to the decoder may result.
5. For Steam units using external synchronization cam capability, connect the White CAM wire of the 10 Pin Sound Harness to the output connection of your cam, and configure CV133 to a value of 128 to make the Steam chuff to be synchronized with the external cam.
6. Inspect the installation before testing the sounds and replacing the shell. In particular be sure that wires are correctly soldered and routed and that the motor and capacitor leads are not shorted to the frame or track.
7. Place the loco on an active DCC track powered by a compatible DCC system and select the factory default address 03 to enable sounds for testing.
8. Be sure F8 (mute) is OFF to allow sound output, and then press F1 (bell) or F2 (whistle/horn) ON to hear the associated sounds.
9. Customize sounds by programming Sound CVs to adjust the desired configurations, as shown in the following tables of SoundFX CVs. Sound schemes other than the 8 factory preloaded can be loaded by using a Digitrax PR3 SoundFX Programmer.

Speaker Mounting and baffle or enclosures.

The sound performance of any attached speaker(s) is greatly affected by the mounting system and required baffle or rear enclosure. The included 8ohm box speaker is pre-mounted in a baffle for your convenience, however additional baffles or other mounting systems may need to be taken into consideration when installing. The baffle is used to isolate the speaker diaphragm front sound waves from the “out of phase” rear sound waves. This minimizes sound cancellation, particularly at lower frequencies. For most efficient sound generation, the cubic volume of the baffle should be as large as practically possible, and the baffle walls should be acoustically rigid so not to allow acoustic interference.

Practical baffle materials are plastic, cardboard and even sheet metal. Common items such as cardboard tubes, soda caps, or 35mm film canisters may be modified and trimmed to create reasonable baffles in the available space. Most HO or O scale or similar locomotives have limited internal volume within the shell, so the choice of speaker mounting benefits from some ingenuity to get best sound performance and space. Of course, you can substitute an alternate after market speaker of the maximum size for the locomotive you have.

Customizing Your Decoder

Your Digitrax SDXH166D SoundFX decoder is ready to run and will operate and generate sound using address 03 with no additional programming. On your Digitrax system, simply select the locomotive’s address and the sound will start. On some DCC systems, it is necessary to select the locomotive address AND send a command to start the sounds. For a more prototypical railroading experience, your decoder can be customized for your specific locomotive by programming some of the Configuration Variables, or CVs, available. Digitrax Sound decoders can be programmed using either a programming track or with the operations mode using the main line. See the Digitrax Decoder Manual or the Digitrax web site for more information.

CAUTION: Programming track must not exceed 16V when programming this decoder.

Digitrax PS14 is the ideal power supply for the PR3.

Initial Test and Programming: This decoder is preprogrammed and tested with a diesel locomotive sound scheme, and is ready to operate on factory default address 03. Before customizing the decoder it is useful to run it on the factory default address 03 to check the installation. The following sections show how to change the locomotive address and customize the decoder.

For more information on general decoder installation and programming techniques and examples visit www.digitrax.com

Changing the Decoder Address

The first CV most people change is the decoder address. This allows you to independently control each loco with a unique address. Digitrax decoders are shipped with CV01 (AD2), the two digit address, set to 03. Following is a brief description of how to change the decoder address with a Digitrax DT4XX series throttle. See your Starter Set Manual for complete programming instructions.

1. Place the loco on the **programming track not to exceed 16V**. Go into Program Mode on your system. On DT4XX throttle press **PROG**.
2. Choose AD2 for 2 digit addressing or AD4 for 4 digit addressing.
3. Choose the address you want to set up for the decoder.
4. Complete address programming by pressing **ENTER**.

Note: CV29 must also be programmed to enable 4 digit addressing, this is done automatically by the DT4XX throttles. See your Digitrax Decoder Manual or the Digitrax Toolbox App for how to set up CV29.

Using this decoder in other locomotives

The factory supplied sound project loaded into the SDXH166D is for a GP38 diesel locomotive, other preloaded projects are selectable with the value in CV60. If you want to install it in a different locomotive, you can simply load a different sound project for that type of locomotive. The cam input is available for Steam installations where you want to synchronize chuffing.

Digitrax LocoMotion® System

Your locomotives look like the real thing, now you can make them run like the real thing, too. Digitrax decoders incorporate torque compensation for smooth as silk operation. You can also program CVs that control momentum, 3 step and 128 step speed tables, switching speed, normal direction of travel, scalable speed stabilization and more to take full advantage of the Digitrax LocoMotion System.

Momentum-CV03 & CV04

Momentum is part of the LocoMotion System. Acceleration is controlled by CV03 and deceleration by CV04. Both come from the factory set to 000. A range of 000 to 031 is available for both accel and decel. Try CV03:003 and CV04:000 as a starting point for experimenting with momentum.

Speed Tables-How the Loco Responds to the Throttle

With Digitrax LocoMotion, there are two types of speed tables: 3 Step Tables and High Resolution 28 Step Tables. Please see your Decoder Manual for a discussion of the 28 Step Tables. The 3 Step Tables are set up by programming 3 CVs: Start Voltage (CV02), Mid point Voltage (CV06) and Max Voltage (CV05). These values are set at 000 at the factory. All have a range of values from 000 to 255. We recommend the following CV values as a starting point for experimenting with speed tables.

| Loco Type | V Start CV02 | V Mid CV06 | V Max CV05 |
|---|-------------------------|-----------------------|-----------------------|
| Switcher Concentrated low speed. Limited top speed | 002 | 038 | 064 |
| Road Switcher Prototypical top speed w/evenly distributed curve from 0 to top speed | 002 | 048 | 098 |
| Mainline Loco Quick increase to cruising speed then levels off to prototypical top speed. | 002 | 128 | 154 |

Decoder Reset CV08

Decoder reset lets you reset all CV values to the initial factory settings. To reset all CV values, program CV08 to a value of 008. You also have the option of resetting all values except the 28 speed step tables. To do this, program CV08 to a value of 009.

Other LocoMotion® Features: Switching Speed, Normal Direction of Travel & Scalable Speed Stabilization (Back EMF) Features

Switching speed is controlled by CV54. The factory setting is 000 for OFF. To turn on the switching speed feature, program CV54 to a value of 001. When this feature is on, use F6 to activate and deactivate switching speed. With the feature on the throttle's target speed is effectively reduced by about 50% and the effects of accel and decel programmed into the decoder are reduced by 1/4. This is useful for yard switching operations.

Normal Direction of Travel is controlled by CV29. See your decoder manual or the Digitrax Toolbox App for additional information on the settings for CV29.

Digitrax SoundFX[®] System

Digitrax SoundFX lets you make your locos sound in scale like the real thing! The SoundFX sound CVs in the range of CV140 to CV256 let you customize your decoder without having to reprogram or change the installed sound scheme.

Diesel Notching CV132 and 155

Sound CV155 is provided to select Diesel engine “notching” modes. The default of CV155= 00 provides “automatic notching” that changes the diesel RPM settings at 8 distinct throttle speeds that are controlled by Sound CV132. Sound CV155=01 selects “semi-automatic notching” mode that allows F6 ON to increase the notch from the current throttle setting and F7 ON to decrease back towards the lowest current throttle notch setting. Sound CV155=02 selects “manual notching” mode that allows F6 ON to increase the notch setting and F7 ON to decrease the notch setting irrespective of the throttle setting, which controls just the motor speed.

Steam Chuff / Cam Configuration and Gear Rotation Trim CV133 and 134

CV133 controls the Steam Chuff / Cam configuration in the decoder it allows you to get the value of the CV equal to the diameter of the driver in inches from 1-27 or to set the CV to 128 to enable the external cam lead. CV134 controls the gear rotation trim where a value of 32 equals a 100% ratio.

Bell and Air Effect Rates CV146-149

CV146 controls the bell rate or time between ring of the bell, it has a range from 1-100 with each increment adding 24ms of delay. CV147 controls the drier rate, it has a range from 1-64 with each increment adding about 2 seconds. CV148 controls the Compressor/ Air pump start rate and CV149 controls how long the Compressor/ Air Pump runs.

Auto Coupler Sequence Threshold Value CV151

CV151 controls the threshold at which coupler and brake sounds are automatically played when locomotive direction is changed and function 3 is enabled. CV151 has a range of 0-60.

| CV60 set to | Sound Scheme | CV150 set to | CV157 set to |
|-------------|---------------------------------|---|---------------------------|
| 0 | GP38 Diesel | 0= default 1-7= alt horns 128-135 = Playable horns | 0=default 1-3 = alt bells |
| 1 | GE Evolution Diesel | 0= default 1-7= alt horns 128-135 = Playable horns | 0=default 1-3 = alt bells |
| 2 | SD70 Diesel | 0= default 1-7= alt horns 128-135 = Playable horns | 0=default 1-3 = alt bells |
| 3 | GP10 Diesel | 0= default 1-7= alt horns 128-135 = Playable horns | 0=default 1-3 = alt bells |
| 4 | RS1 Diesel | 0= default 1-7= alt horns 128-135 = Playable horns | 0=default 1-3 = alt bells |
| 5 | C420 Diesel | 0= default 1-7= alt horns 128-135 = Playable horns | 0=default 1-3 = alt bells |
| 6 | Steam type 1 (based on 3985) | 0= default 1-2= alt whistles 128-130 = Playable whistles | 0=default 1-3 = alt bells |
| 7 | Steam type 2 (based on K27) | 0= default 1-2= alt whistles 128-130 = Playable whistles | 0=default 1-3 = alt bells |

Changing the Sound Scheme on your SDHX166D CV60, 150, 157

The SDHX166D comes preloaded with 8 different sound schemes, 6 diesel and 2 Steam. These schemes can be selected using CV60. Each diesel scheme can be configured with one of 8 different horns using CV150 and one of 4 different bells using CV157. Each Steam scheme can be configured with one of 3 whistles using CV150 and one of 4 bells using CV157. To enable playable volume for your selected horn or whistle add 128 to the selected value (ex. Playable volume on horn 2 is enabled with a value of 130, 02+128=130)

Loading Other Sound Schemes in your SDHX166D

The decoder's sound scheme can be changed using a Digitrax PR3 programmer and your computer with the SoundLoader 2.0 software. Both the software and a number of alternate sound project files are available from the Digitrax Sound Depot web site. It takes only a few minutes to download the new sound to your decoder. The following tables show the CVs used in this decoder version and how it is set up at the factory to operate various sounds using your throttle. (**Table on next page.**)

| CV# | Used For | Range | Default Value |
|-----|---|-------------------------|---------------|
| 01 | 2 Digit Address | | 03 |
| 11 | Sound Time Out, 06 = Sound ends when loco address is de-selected, 00=Sound stays on after loco is de-selected | | 06 |
| 29 | Configuration Register - Advanced or Standard speed steps, 2 or 4 digit addressing, Analog Mode, Normal direction of travel, speed tables | | 06 |
| 49 | Forward Light (FOF) - Headlight | | 00 |
| 50 | Reverse Light (FOR) - Reverse Light | | 00 |
| 51 | Function 1 | | 00 |
| 52 | Function 2 | | 00 |
| 58 | Master Volume (F8 used for Mute) 1=min 00=max | 00-15 | 09 |
| 60 | Sound Scheme Select | 00-07 | 00 |
| 132 | Notch Rate | 00-255 | 127 |
| 133 | Steam Chuff/CAM config, 128=>EXT cam, 1-127=>DRIVER dia in inches | 01-128 | 63 |
| 134 | Steam Gear Ration Trim, 32 = 100% Ratio | 00-255 | 32 |
| 135 | Mute Volume | 00-64 | 00 |
| 140 | Prime Mover / Chuff Volume | 00-64 | 60 |
| 141 | Bell Volume | 00-64 | 25 |
| 142 | Horn/Whistle Volume | 00-64 | 60 |
| 143 | Time-Scattered Air Effects Volume | 00-64 | 30 |
| 145 | Misc Vols | 00-64 | 40 |
| 146 | Bell Ring Rate (1=24 milliseconds) | 01-100 | 07 |
| 147 | Air Drier Rate (1-about 2 seconds) | 01-64 | 02 |
| 148 | Compressor Run Rate | 00-255 | 30 |
| 149 | Air Compress On Time | 00-255 | 20 |
| 150 | Horn/Whistle Setup (Default=0, Playable Horn=1, Alternate Horn=2 +128 for playable volume.) | 00-07 or 128- 135 | 00 |
| 151 | Auto Coupler Sequence Threshold Value-Peak speed to allow auto coupler/brake when direction change occurs and F3 is ON | 00-64 | 48 |
| 152 | Project Author ID, Digitrax=221 | | 221 |
| 153 | Project ID | | 168 |
| 154 | Steam Blow down / Safety Volume | 0-64 | 60 |
| 155 | Notching/Slip Mode: 00=Automatic, | | 00 |
| 157 | Bell Selector | 00-03 | 00 |

| Function | Used For | Notes |
|----------|--|--|
| F0 | Lights | |
| F1 | Bell | |
| F2 | Horn/Whistle | CV150 sets mode |
| F3 | Coupler crash | Auto coupler/brake set by CV151 max speed |
| F4 | Air feature disable | F4 off enables pop-off, drier and starts compressor/airpump |
| F5 | Diesel = Dynamic brake Fans Steam = Water Pump turbine | |
| F6 | Diesel = Notch Up Steam = Blowdown | Notch UP if CV155=01 or 02 |
| F7 | Crossing Gate Airhorn or; Diesel = Notch DOWN Steam = Wheelslip | Notch DOWN, if CV155 = 01 or 02 (Crossing Gate active if in Diesel mode and CV155=0) |
| F8 | Mute Control | F8 ON is mute |
| F9 | Brake squeal | |
| F10 | Crossing Gate Airhorn Sequence | |
| F11 | Steam = Greaser | |
| F12 | Steam = Safety Blowoff | |

SoundFX DC Operation Mode

Digitrax SoundFX decoders will operate on smooth DC power. The sound will not start until approximately 7 volts is applied to the track and there will be no “start up sound.”

SDXH166D Troubleshooting

If the sound does not start in the decoder

1. Make sure you have selected the locomotive address on a throttle. The sound will not run unless the locomotive is addressed in the system.
2. Check your installation to make sure the decoder is installed properly.

If the sound output sounds distorted

1. Check the speaker cone for magnetic debris that may have collected there. Debris on the speaker will cause a loss of sound quality and must be removed.

2. Be sure that the CV58 volume is not set at a level that is too high for the speaker being used.

If the sound in your decoder shuts down after you stop it and you are not using a Digitrax system for control. On some DCC systems decoders are not addressed by DCC packets after the locomotive is set to 0 speed. In this case after the CV11 timeout elapses (6 second default), sound will “shutdown.” To defeat this feature, set CV11=00 to remove the timeout and shutdown. *To make sounds, the decoder must have a command addressed to it at least once.*

If you have trouble reading back CVs on the programming track, this may be due to insufficient current draw. Of course you can always just re-program the CV value into a CV to get the desired results, even if reading CVs does not work. OPS mode is recommended for writing to (programming) all CVs except CV01, CV17 & CV18 (2 digit and 4 digit addresses). If a second DCC decoder is present that is not SoundFX compatible then correct read back of CV data is not possible, since the NMRA CV read back was not designed for multiple decoder read back.

The SDXH166D plays a Steam scheme, but I want the default Diesel scheme. If the factory scheme has not been erased, program CV60 to a value of 0 to reselect the default GP38 diesel scheme.

I have loaded a new scheme but the CVs and Functions are not what I expected. Load the sound project you programmed and then select the view>project description” menu and then read the text file on the screen that defines how that project in particular uses CVs and functions for sound generation and configuration.

Warranty & Repair

Digitrax gives a one year “*No Worries*” *Warranty* against manufacturing defects and accidental customer damage on all Digitrax command stations, boosters, throttles, decoders, power supplies and layout control devices.

That’s it! A simple, straightforward warranty with no tricky language!

Visit www.digitrax.com for complete warranty details and instructions for returning items for repair.

Please return warranty items directly to Digitrax - DO NOT return items to place of purchase.

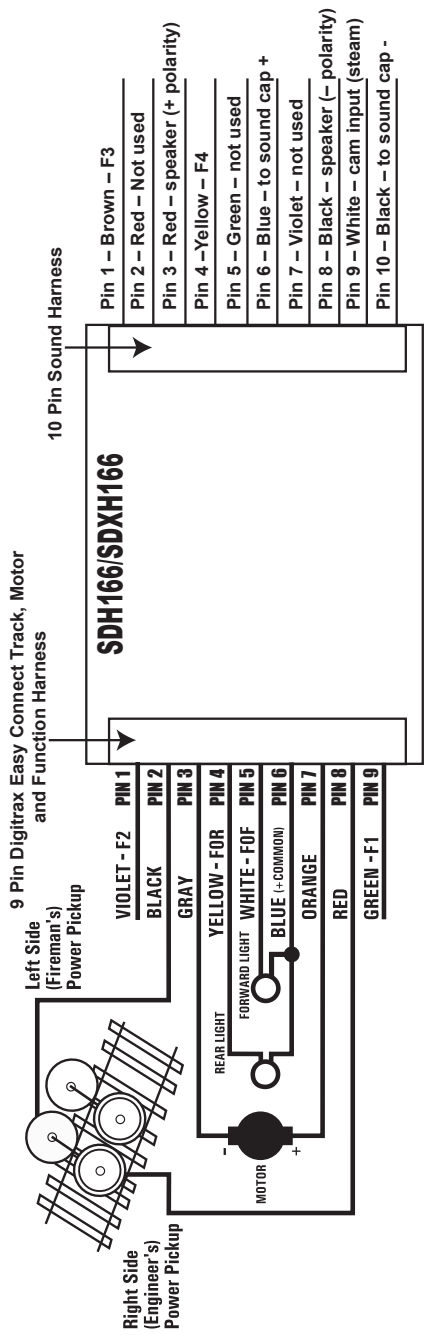

Figure 3: SDXH166D: connection diagram



SDXH166D

Wired Sound + Motor + Function Decoder for HO scale locomotives

Go Beyond DCC With Digitrax® Complete Train Control

Main Station

Starter Sets
LocoNet®
Power Supplies



Your Digitrax LocoNet® Starter Set is just the beginning of an exciting trip! Pick the one that's right for you!



LocoNet®
The Digitrax
Difference

Locomotive Shops

Mobile Decoders
Function Decoders
SoundFX™ Decoders

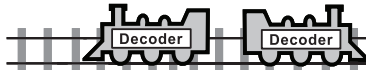

More Fun For Everyone

Add More Boosters, Advanced & Simple Throttles, Power Supplies, Universal Panels, IR and/or Radio for more trains and operators.

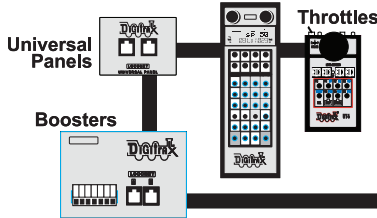

Maintenance Of Way

Make your layout more fun & simpler to operate!

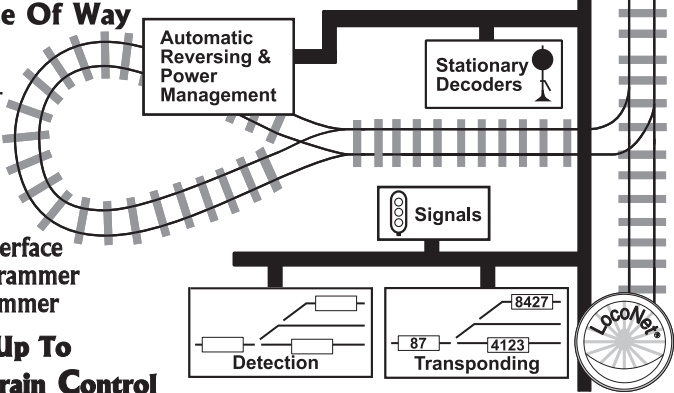

Computer Controls

Computer Interface
Decoder Programmer
Sound Programmer

It All Adds Up To Complete Train Control



2443 Transmitter Road
Panama City, FL 32404

www.digitrax.com

Made in the USA

Contact: www.digitrax.com/contact

Support: techsupport@digitrax.com

Repair: repair@digitrax.com

SDXH166D

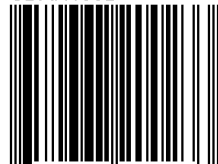

6 52667 20023 3

