



**Complete Train Control**  
Run Your Trains, Not Your Track!

**N Scale**

# DZ125IN

Fits Many N Locomotives

**Mobile Decoder**  
**1 Amp/1.25 Amp Peak**  
**2 FX<sup>3</sup> Functions, 0.5 Amp**  
**with 6 Pin NEM 651 type plug fit Kato**  
**N-EMD class 66, Fox Valley N Scale,**  
**and others**

## Features:

---

- **Plug N'Play decoder:** for 6-pin socket N scale locomotives
- **Digitrax LocoMotion<sup>®</sup> System-**Your locomotives look like the real thing. The Digitrax LocoMotion<sup>®</sup> System makes them run like the real thing, too!
  - Torque Compensation** for smooth as silk silent operation.
  - 128 Speed Step** operation (14 or 28 steps can also be used).
  - Momentum** with acceleration and deceleration.
  - Normal Direction of Travel** is user selectable.
  - Switching Speed** feature for easier and faster access to yard speeds.
  - 3 Step Speed Tables** set start, mid and max voltage for custom control.
  - 28 Step Speed Tables** with 256 level resolution for precise control.
- **Scaleable Speed Stabilization (Back EMF)** with simple setup & 256 level resolution.
- **SuperSonic** motor drive for silent operation.
- **FX<sup>3</sup> Function outputs** for prototypical lighting effects and on/off control:
  - Constant Brightness Lighting** with directional or independent control.
  - Realistic Effects** like Ditch lights, Mars lights, strobes, and many more.
  - FX<sup>3</sup> & Standard Function Qualifiers** operate functions based on direction, F0 on or off, direction and F0, and whether loco is moving.
  - Function Remapping** of 14 functions for custom function setup.
  - Master Light Switch** turns off all lights & functions with one keystroke.
- **Transponder ID Equipped** ready for transponding on your Layout, for e.g. a Digital surround-sound system
- **All Mode Programming**
- **Decoder Reset CV** with or without speed table reset.
- **Motor Isolation Protection** prevents damage to your decoder.
- **Basic, Advanced & UniVersal Consisting**
- **2 Digit and 4 Digit Addressing**
- **Up to 20V DCC/DC track** voltage operation, maximum
- **DCC Compatible**

---

## Parts List

---

1 DZ125IN Decoder

1 Instruction sheet

---

## Installation Information

---

See the Digitrax Decoder Manual for complete decoder test procedures, installation instructions, programming and technical information. Digitrax manuals and instructions are updated periodically. Please visit [www.digitrax.com](http://www.digitrax.com) for the latest versions, technical updates and available locomotive-specific installation instructions.

---

## Installation Instructions

---

1. Carefully remove the locomotive's shell from the frame. Notice the orientation of the shell to the frame so that you can reinstall correctly.
2. Remove the 6 pin analog shorting plug and in its place insert the DZ125IN decoder with the correct pin-1 orientation. The DZ125IN has 6 pins that insert directly into the 6 pin socket (NEM 651 type) on the locomotive's PCB. The DZ125IN's small size allows the decoder to be easily installed in a variety of European locomotives. For the Kato EMD Class 66 example, the DZ125IN should be inserted in the socket as shown in Figure 2.

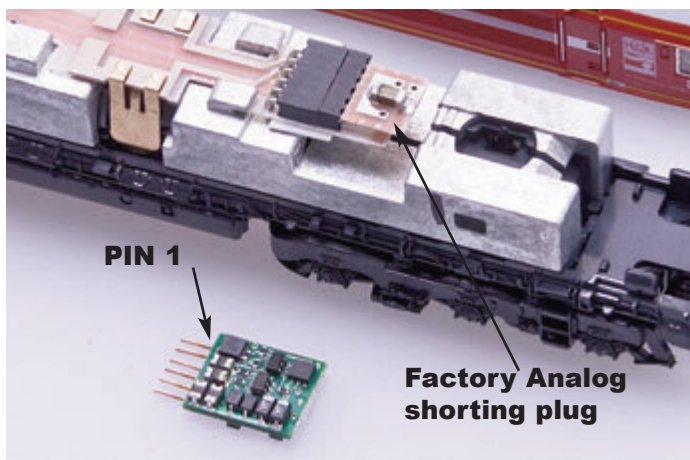

(Figure 1): Kato factory N-EMD class 66

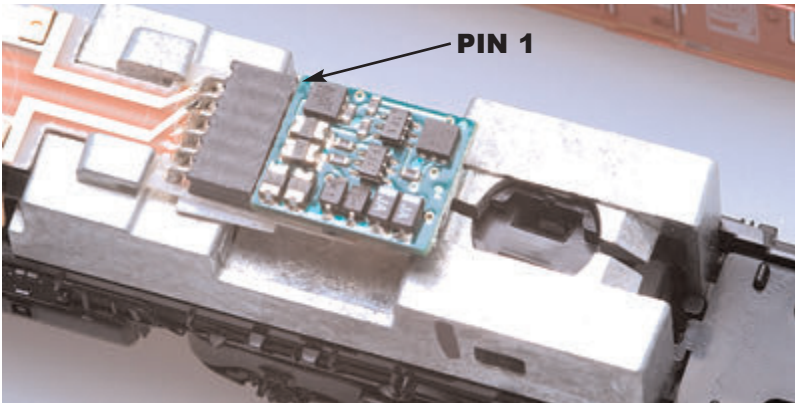

(Figure 2): Kato N-EMD class 66 with DZ125IN installed

3. Test the locomotive on some track with a DCC system to verify motor and lights work in both directions.
4. Reinstall the locomotive's shell.

For proper installation orientation in **Bachmann Farish Jubilee, the Dapol Hymek and the Trix v160 N scale examples, please refer to page 9** in this guide. For other N scale locomotives be sure to identify the correct pin-1 location of the locomotive socket from the manufacturer's instructions.

Figure 3. DZ125IN Wiring Diagram

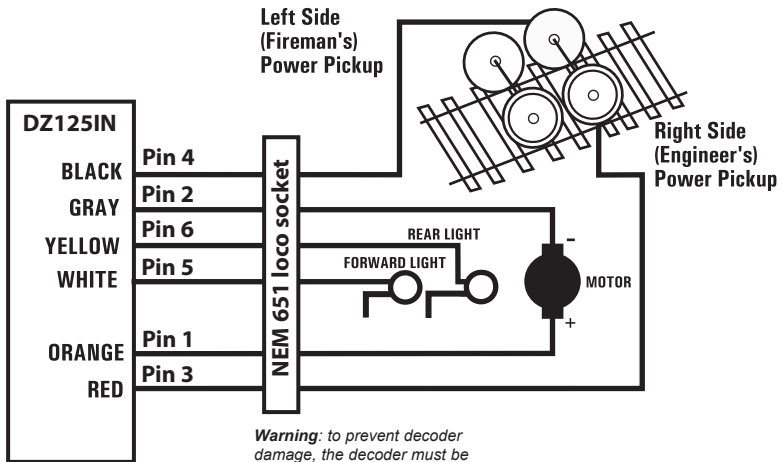



DZ125IN is factory default programmed to address 03. You can easily customize the address and other features. See section “Customizing Your Decoder”.

**Installation Notes:**

1. Do not exceed the decoder’s 500mA total function output rating.
2. If the decoder is installed in a location where it may come in contact with other metal parts of the locomotive, use tape to insulate the decoder to avoid short circuits.
3. To use a function output with an inductive (coil) type load, see the Digitrax Decoder Manual for more information to avoid damage to the decoder.
4. See the Digitrax Decoder Manual for full details of wiring 12-16V lamps, 1.5V lamps, and LEDs. Lamps that draw more than 80 mA when running require a 22 ohm 1/4 watt resistor in series with the directional light function lead to protect the decoder.
5. Some locomotives employ filter capacitors for RFI suppression in the locomotive wiring. These may cause problems with Supersonic decoders and non-decoder analog operation on DCC. This capacitor should be removed for safe operation.

**Customizing Your Decoder**

---

Your Digitrax decoder is ready to run and will operate using address 03 with no additional programming. For a more prototypical railroading experience, your decoder can be customized for your specific locomotive by programming some of the Configuration Variables, or CVs, available. See the Digitrax Decoder Manual or the Digitrax web site for more information.



---

## Changing the Decoder Address

---

The first CV most people change is the decoder address. This allows you to independently control each loco with a unique address. Digitrax decoders are shipped with CV01 (AD2), the two digit address, set to 03. Following is a brief description of how to change the decoder address with a Digitrax DT series throttle. See your Starter Set Manual for complete programming instructions.

1. Place the loco on the programming track. Go into Program Mode on your system. On DT400 press **PROG**. On DT300, DT100 & DT200 press **RUN/STOP & FN/F0**.
2. Choose AD2 for 2 digit addressing or AD4 for 4 digit addressing (DT300 & DT400). (Ad for DT100 & DT200, see your Starter Set manual for 4 digit instructions).
3. Use your throttle to choose the address you want to set up for the decoder.
4. Complete address programming. On DT400 press **ENTER**. On DT300, DT100 & DT200 press **SEL**.

**Note:** CV29 must also be programmed to enable 4 digit addressing, this is done automatically by the DT300 & DT400 but not on earlier throttles.



---

## **Digitrax LocoMotion® system**

---

Your locomotives look like the real thing, now you can make them run like the real thing, too. Digitrax decoders incorporate torque compensation for smooth as silk operation. You can also program CVs that control momentum, 3 step and 128 step speed tables, switching speed, normal direction of travel and more to take full advantage of the Digitrax LocoMotion® System.

---

## **Momentum-CV03 & CV04**

---

Momentum is part of the LocoMotion® System. Acceleration is controlled by CV03 and deceleration by CV04. Both come from the factory set to 000. A range of 000 to 031 is available for both accel and decel. We recommend that you try CV03:003 and CV04:000 as a starting point for experimenting with momentum.

---

## **speed Tables-How the Loco Responds to the Throttle**

---

With Digitrax LocoMotion®, there are two types of speed tables: 3 Step Tables and High Resolution 28 Step Tables. Please see your Digitrax Decoder Manual for a discussion of the 28 Step Tables. The 3 Step Tables are set up by programming 3 CVs: Start Voltage (CV02), Mid point Voltage (CV06) and Max Voltage (CV05). These values are set at 000 at the factory. All have a range of values from 000 to 255. We recommend the following CV values as a starting point for experimenting with speed tables.

<b>Loco Type</b>	<b>V Start CV02</b>	<b>V Mid CV06</b>	<b>V Max CV05</b>
<b>Switcher</b> Concentrated low speed. Limited top speed	002	038	064
<b>Road Switcher</b> Prototypical top speed w/evenly distributed curve from 0 to top speed	002	048	098
<b>Mainline Loco</b> Quick increase to cruising speed then levels off to prototypical top speed.	002	128	154



---

## o ther LocoMotion<sup>®</sup> Features: switching speed & Normal Direction of Travel

**Switching speed** is controlled by CV54. The factory setting is 000 for OFF. To turn on the switching speed feature, program CV54 to a value of 001. When this feature is on, use F6 to activate and deactivate switching speed. When switching speed is ON and F6 is ON, the switching speed feature is on. With the feature ON, the throttle's target speed is effectively reduced by about 50% and the effects of accel and decel programmed into the decoder are reduced by 1/4. This is useful for yard switching operations.

**Normal Direction of Travel** is controlled by CV29. See your decoder manual for additional information on the settings for CV29.

This decoder **supports** Scaleable Speed Stabilization (Back EMF)

---

## supersonic silent operation and Torque Compensation

The factory settings in the decoder provide silent, smooth operation of your locomotive under most conditions. For more information about these settings, please see the Digitrax Decoder Manual or our website.

---

## Digitrax Transponding CV61

**Digitrax Transponding** is controlled by CV61. The initial factory set value is 000 for **OFF**. To turn **ON** transponding, program CV61 to a value of 002. This allows you to use Digitrax transponding to keep track of your rolling stock. When transponding is enabled, the front light of the locomotive will flicker slightly to indicate transponding signal is being communicated. For optimal transponding operation, we recommend that you hook up the forward and rear lights as shown in the wiring diagram (*Figure 1*).

---

## Decoder Reset CV08

**Decoder reset** lets you reset all CV values to the initial factory settings. To reset all CV values, program CV08 to a value of 008. You also have the option of resetting all values except the 28 speed step tables. To do this, program CV08 to a value of 009.



---

## **Function 0 outputs on the DZ125IN**

---

The DZ125IN is set up at the factory to control two function outputs. The DZ125IN is configured to control the forward and reverse lights on the locomotive through the white lead and yellow lead using Function 0 (F0F-forward and F0R-reverse) for directional lighting. Both function outputs can be easily set up with Digitrax FX<sup>3</sup> lighting effects or as standard on/off functions with the following operational qualifiers:

1. Forward or Reverse direction of travel, or
2. Whether F0 is on or off, or
3. Both direction of travel and whether F0 is on or off, or
4. Whether the locomotive is stopped or moving.

---

## **Master Light switch**

---

Each of the function outputs can be programmed to turn on and off with the F0 ON/OFF key on your throttle, creating a Master Light Switch. The CV values for creating this effect are listed in the Digitrax Decoder Manual in the section: *Setting Up FX & FX<sup>3</sup> Effects on Function Outputs.*

---

## **Warranty & Repair**

---

Digitrax gives a one year *"No Worries" Warranty* visit [www.digitrax.com](http://www.digitrax.com) for more details!**That's it! A simple, straightforward warranty with no tricky language!**

Visit [www.digitrax.com](http://www.digitrax.com) for complete warranty details and instructions for returning items for repair.

**Damaged decoders should be returned directly to Digitrax for repair.**

*Digitrax, Inc. reserves the right to make changes in design and specifications, and/or to make additions or improvements in its products without imposing any obligations upon itself to install these changes, additions or improvements on products previously manufactured.*

**Digitrax, Inc. is not responsible for unintentional errors or omissions in this document.**



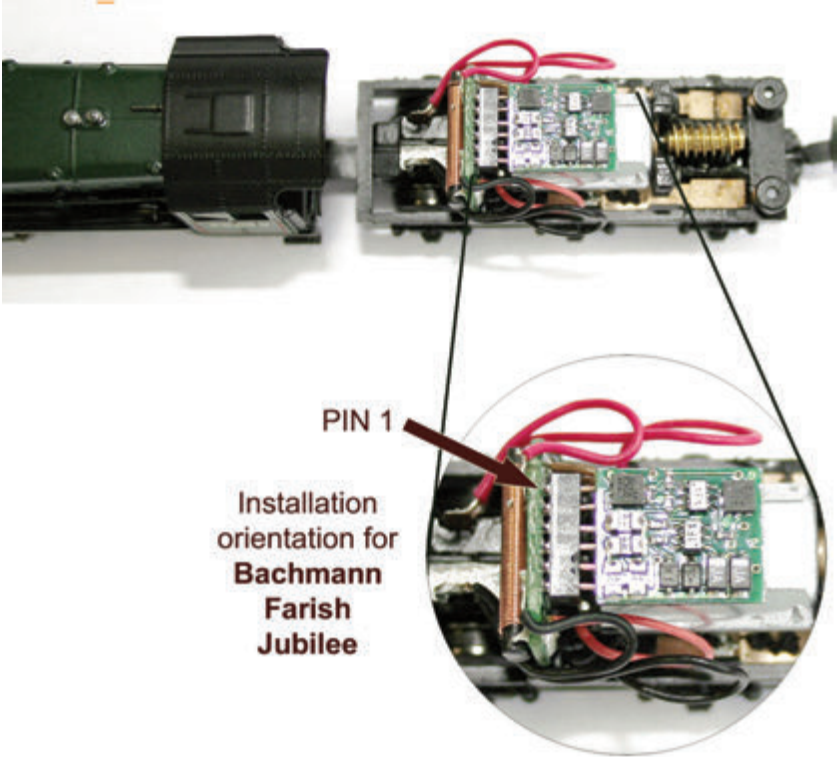

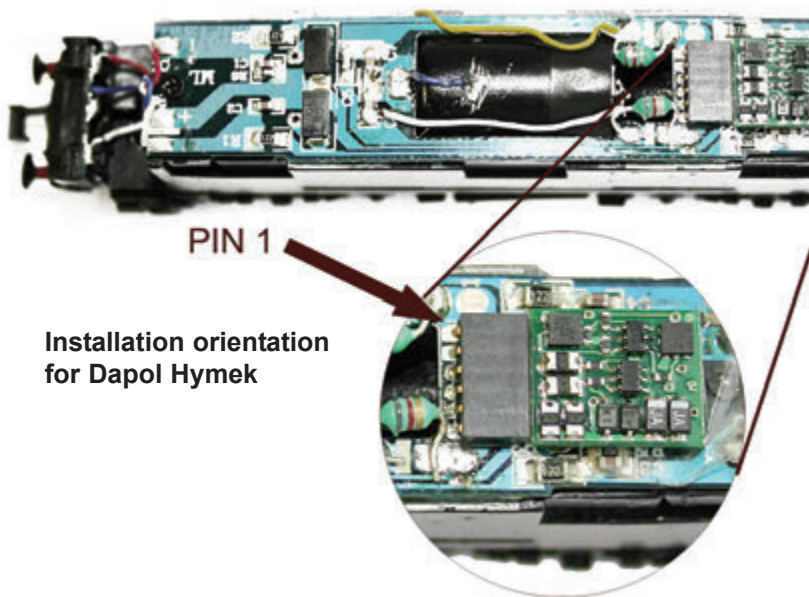

**PIN 1**

**Installation orientation  
for Dapol Hymek**

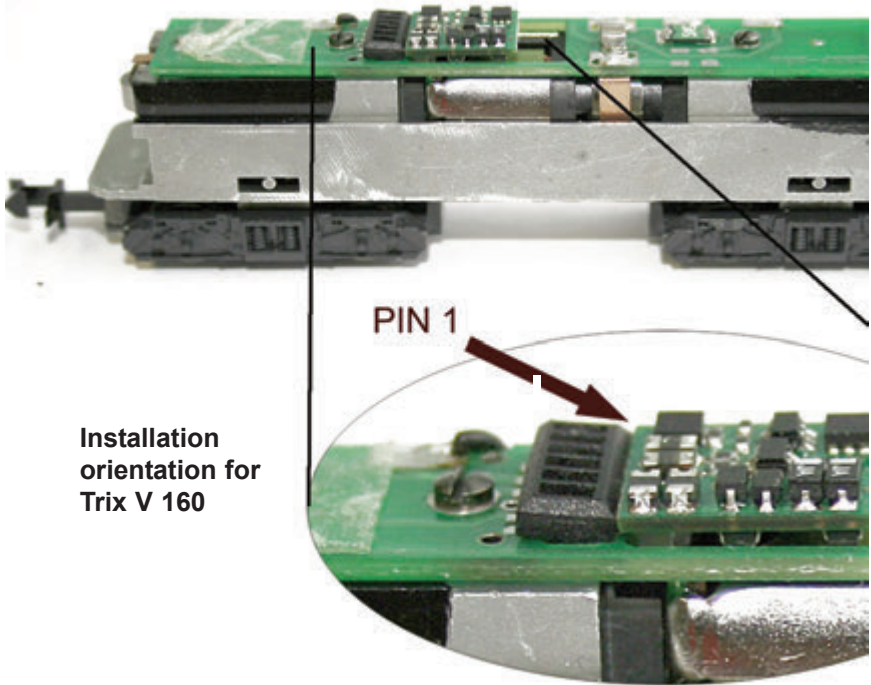

Installation orientation for Trix V 160

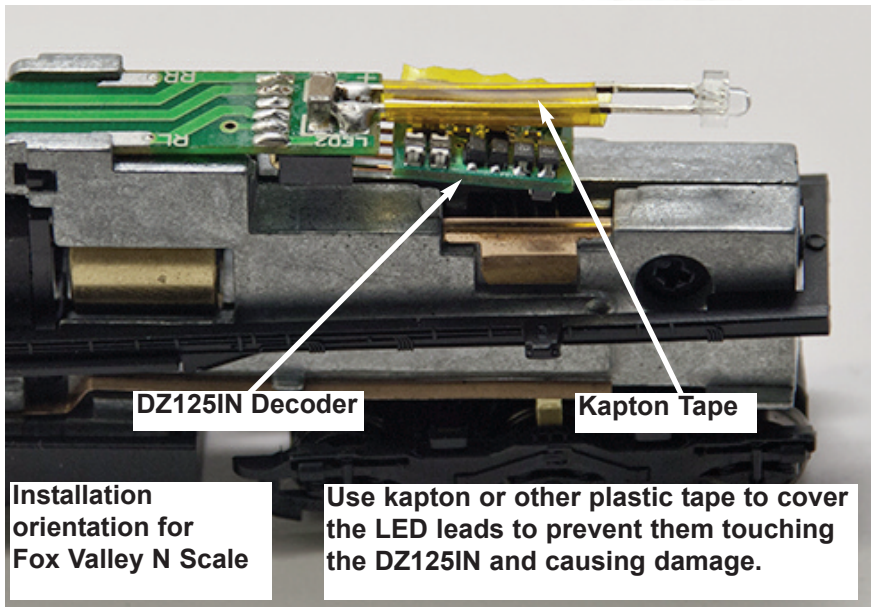

Installation orientation for Fox Valley N Scale

Use kapton or other plastic tape to cover the LED leads to prevent them touching the DZ125IN and causing damage.



# DZ125IN

Fits a Variety of N Scale Locomotives

## Go Beyond DCC With



## Complete Train Control

### Main Station

Starter Sets  
LocoNet®  
Power Supplies



Your Digitrax LocoNet® Starter Set is just the beginning of an exciting trip! Pick the one that's right for you!



**LocoNet®**  
The Digitrax Difference

### Locomotive Shops

Mobile Decoders  
Function Decoders  
SoundFX™ Decoders

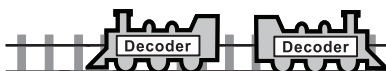

### More Fun For Everyone

Add More Boosters, Advanced & Simple Throttles, Power Supplies, Universal Panels, IR and/or Radio for more trains and operators.

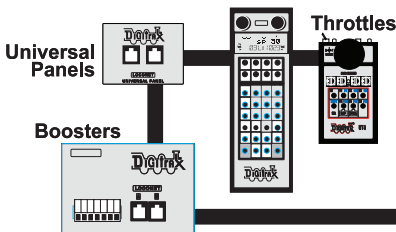

### Maintenance Of Way

Make your layout more fun & simpler to operate!

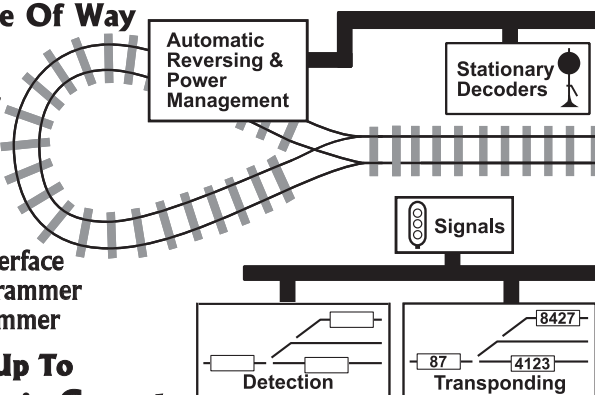

### Computer Controls

Computer Interface  
Decoder Programmer  
Sound Programmer

### It All Adds Up To Complete Train Control



2443 Transmitter Road  
Panama City, FL 32404

[www.digitrax.com](http://www.digitrax.com)

su PPO RT: [techsupport@digitrax.com](mailto:techsupport@digitrax.com)

RePAIR: [repair@digitrax.com](mailto:repair@digitrax.com)

Made in U.S.A.



DZ125IN



6 52667 05055 5

307-DZ125IN-INS