



---

## DN166I2

Fits InterMountain N Scale FP 7  
.472" x 2.165" x .098"  
11.98mm x 54.99mm x 2.4mm

N Scale  
Mobile Decoder  
Board Replacement  
1.5 Amp/2.0 Amps Peak  
6 FX<sup>3</sup> Functions, 0.5 Amp

### Features:

---

- FX<sup>3</sup> Function outputs for prototypical lighting effects and on/off control:
  - Constant Brightness Lighting** with directional or independent control.
  - Optimized selectable LED or incandescent lamp operation**
  - Realistic Effects** like Ditch lights, Mars lights, strobes, and many more
  - Configurable Pulse Function** available on all function outputs.
  - FX<sup>3</sup> & Standard Function Qualifiers** operate functions based on direction, Fo on or off, direction and Fo, and whether loco is moving.
  - Function Mapping** for custom function setup.
  - Master Light Switch** turns off all lights & functions with one keystroke.
  - Advanced Consist Function Controls.**
- **Digitrax LocoMotion® System**-Your locomotives look like the real thing. The Digitrax LocoMotion System makes them run like the real thing, too!
  - Scaleable Speed Stabilization (Back EMF)** with simple setup & 256 level resolution.
  - Torque Compensation.**
  - 128 Speed Step** operation (14 or 28 steps can also be used).
  - Momentum** with acceleration and deceleration.
  - Normal Direction of Travel** is user selectable.
  - Switching Speed** feature for easier and faster access to yard speeds.
  - 3 Step Speed Tables** set start, mid and max voltage for custom control.
  - 28 Step Speed Tables** with 256 level resolution for precise control.
- Program CVs using any Digitrax Compatible Control system without having to buy any extra equipment.
- 2 Digit and 4 Digit Addressing.
- Basic, Advanced & UniVersal Consisting.
- SuperSonic motor drive for silent operation.
- Direct mode programming.
- Decoder Reset CV with or without speed table reset.
- Transponder Equipped ready for transponding on your Layout.
- Motor Isolation Protection helps prevent damage to your decoder.
- Automatic Analog Mode Conversion when running on DC layout.
- Decoder Lock for individual programming of multiple decoders in one loco.
- Digitrax "No Worries" Warranty.

## Parts List

1 DN166I2 Mobile Decoder

1 Instruction Sheet

## Installation Information

See the Digitrax Decoder Manual for complete decoder test procedures, installation instructions, programming and technical information. Digitrax manuals and instructions are updated periodically. Please visit [www.digitrax.com](http://www.digitrax.com) for the latest versions, technical updates and additional locomotive-specific installation instructions. **CAUTION: Programming and layout track must not exceed 16V when using this decoder.**

## Installation Instructions

1. Carefully remove the locomotive's shell from the frame by inserting two toothpicks under the unit's ladders as shown.
2. Once you've positioned the toothpicks, grasp the frame and toothpicks with one hand and the locomotive's shell with the other hand and carefully separate the two.
3. Once the shell is off, remove the existing light board by removing the two screws located on the diagonal corners of the board. The final step in removing the light board is to carefully unsolder the two wires leading from the headlight assembly.
4. Take the new DN166I2 decoder and place it on top of the frame. Note proper orientation. The decoder's brass motor contacts should fit in the frame slot as shown.
5. Solder headlight leads to the new decoder board as shown **If you were sitting in the cab, the yellow lead would be on your left and the green lead would be on your right.** The final step is to secure the decod-

Toothpicks inserted under the steps

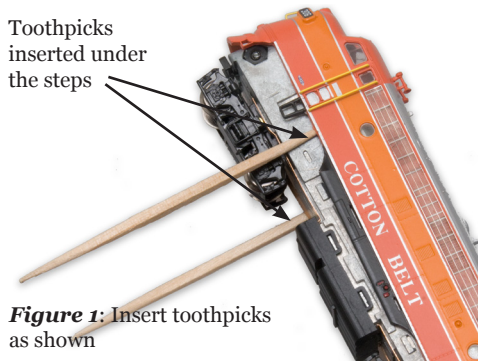
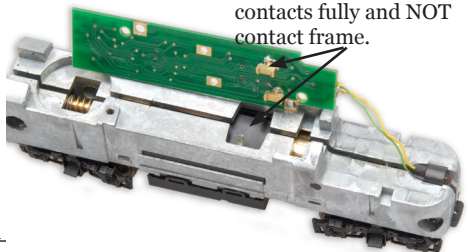

**Figure 1:** Insert toothpicks as shown



**Figure 2:** Grasp toothpicks and gently remove shell from frame.

Decoder's brass contacts should engage motor contacts fully and NOT contact frame.



**Figure 3:** Unscrew, unsolder and remove standard lightboard.

er with the original screws. Note: the locomotive's frame halves may have to be loosened slightly to achieve proper alignment.

**CAUTION:** When attaching headlight wires, be very careful that the wires you attach do not come into contact with any other pads or components on the board where they might create a short circuit.

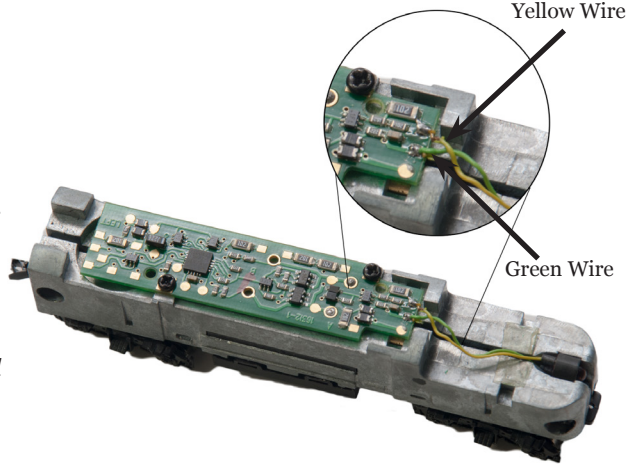

**Figure 4:** Solder headlight wires, secure new decoder with original screws

## Installation Notes

1. Do not exceed the decoder's 500mA total function output rating.
2. We recommend that the Blue wire, also called +Common or Lamp Common, be connected as shown. If you wish to omit the Blue wire in your installation, consult the Digitrax Decoder Manual for more information.
3. The head lamp should be hooked up using the Blue/+Common wire for optimal Digitrax transponding operation.
4. To use a function output with an inductive (coil) type load, see the Digitrax Decoder Manual for more information to avoid damage to the decoder.
5. See the Digitrax Decoder Manual for full details of wiring 12-16V lamps, 1.5V lamps, and LEDs. Lamps that draw more than 80 mA when running require a 22 ohm 1/4 watt resistor in series with the directional light function lead to protect the decoder.
6. Some locomotives employ filter capacitors for RFI suppression in the locomotive wiring. These may cause problems with Supersonic decoders and non-decoder analog operation on DCC. This capacitor should be removed for safe operation.

## Customizing Your Decoder

Your Digitrax decoder is ready to run and will operate using address 03 with no additional programming. For a more prototypical railroading experience, your decoder can be customized for your specific locomotive by programming some of the Configuration Variables, or CVs, available. See the Digitrax Decoder Manual or the Digitrax web site for more information.

## Changing the Decoder Address

---

The first CV most people change is the decoder address. This allows you to independently control each loco with a unique address. Digitrax decoders are shipped with CV01 (AD2), the two digit address, set to 03. Following is a brief description of how to change the decoder address with a Digitrax DT4XX series throttle. See your Starter Set Manual for complete programming instructions.

1. Place the loco on the **programming track not to exceed 16V**. Go into Program Mode on your system. On DT4XX throttle press **PROG**.
2. Choose AD2 for 2 digit addressing or AD4 for 4 digit addressing.
3. Choose the address you want to set up for the decoder.
4. Complete address programming by pressing **ENTER**.

**Note:** CV29 must also be programmed to enable 4 digit addressing, this is done automatically by the DT4XX throttles. See your Digitrax Decoder Manual or the Digitrax Toolbox App for how to set up CV29.

## Digitrax LocoMotion® System

---

Your locomotives look like the real thing, now you can make them run like the real thing, too. Digitrax decoders incorporate torque compensation for smooth as silk operation. You can also program CVs that control momentum, 3 step and 128 step speed tables, switching speed, normal direction of travel, scalable speed stabilization and more to take full advantage of the Digitrax LocoMotion System.

## Momentum-CV03 & CV04

---

Momentum is part of the LocoMotion System. Acceleration is controlled by CV03 and deceleration by CV04. Both come from the factory set to 000. A range of 000 to 031 is available for both accel and decel. Try CV03:003 and CV04:000 as a starting point for experimenting with momentum.

## Speed Tables-How the Loco Responds to the Throttle

---

With Digitrax LocoMotion, there are two types of speed tables: 3 Step Tables and High Resolution 28 Step Tables. Please see your Decoder Manual for a discussion of the 28 Step Tables. The 3 Step Tables are set up by programming 3 CVs: Start Voltage (CV02), Mid point Voltage (CV06) and Max Voltage (CV05). These values are set at 000 at the factory. All have a range of values from 000 to 255. We recommend the following CV values as a starting point for experimenting with speed tables.

<b>Loco Type</b>	<b>V Start CV02</b>	<b>V Mid CV06</b>	<b>V Max CV05</b>
<b>Switcher</b> Concentrated low speed. Limited top speed	002	038	064
<b>Road Switcher</b> Prototypical top speed w/evenly distributed curve from 0 to top speed	002	048	098
<b>Mainline Loco</b> Quick increase to cruising speed then levels off to prototypical top speed.	002	128	154

## **Other LocoMotion® Features: Switching Speed, Normal Direction of Travel & Scalable Speed Stabilization (Back EMF) Features**

---

**Switching speed** is controlled by CV54. The factory setting is 000 for OFF. To turn on the switching speed feature, program CV54 to a value of 001. When this feature is on, use F6 to activate and deactivate switching speed. With the feature on the throttle's target speed is effectively reduced by about 50% and the effects of accel and decel programmed into the decoder are reduced by 1/4. This is useful for yard switching operations.

**Normal Direction of Travel** is controlled by CV29. See your decoder manual or the Digitrax Toolbox App for additional information on the settings for CV29.

The intensity, or droop, of **Scaleable Speed Stabilization** (Back EMF) is controlled by CV57. The factory setting for this feature is 006 which is suitable for most locos. You can adjust this value in the range of 000 for OFF to 015 for the maximum effect. Consult your Digitrax Decoder Manual for info about CVs 55 & 56 and their effects on scaleable speed stabilization.

## **SuperSonic Silent Operation and Torque Compensation**

---

The factory settings in the decoder provide silent, smooth operation of your locomotive under most conditions. For more information about these settings, please see the Digitrax Decoder Manual or our website.

## Function Outputs on the DN166I2

---

The DN166I2 is set up at the factory to control six functions. The unit has two sets of outputs for directional lighting. Pads FoF/FoF+ are for the front light and FoR/FoR+ for the rear light. Functions F1 , F2 , F3 and F4 can be used by soldering a wire from the pad for the function you wish to use to the lamp (or other function) you wish to control.

All six function outputs can be easily set up with Digitrax FX3 lighting effects or as standard on/off functions with the following operational qualifiers:

1. Forward or Reverse direction of travel, or
2. Whether Fo is on or off, or
3. Both direction of travel and whether Fo is on or off, or
4. Whether the locomotive is stopped or moving.

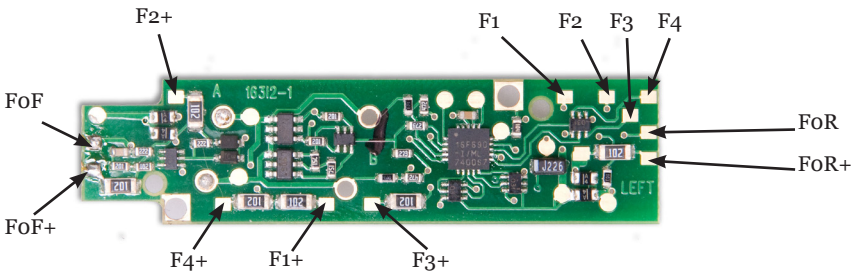

## Function Remapping

---

Function remapping allows you to program the function outputs of your decoder to be controlled by selected function keys on your throttle. Please consult the Digitrax Decoder Manual or website for information on function remapping.

## **Digitrax Transponding CV61**

---

Digitrax Transponding is controlled by CV61. The initial factory set value is 000 for OFF. To turn on transponding, program CV61 to a value of 002. This allows you to use Digitrax transponding to keep track of your rolling stock. When transponding is enabled, the front light of the locomotive will flicker slightly to indicate transponding signal is being communicated. For optimal transponding operation, we recommend that you hook up the forward and rear lights as shown above.

## **Decoder Reset CV08**

---

Decoder reset lets you reset all CV values to the initial factory settings. To reset all CV values, program CV08 to a value of 008. You also have the option of resetting all the CV values except the 28 speed step tables. To do this program CV08 to a value of 009.

## **Warranty & Repair**

---

Digitrax gives a one year “*No Worries*” *Warranty* against manufacturing defects and accidental customer damage on all Digitrax command stations, boosters, throttles, decoders, power supplies and layout control devices.

**That’s it! A simple, straightforward warranty with no tricky language!** Visit [www.digitrax.com](http://www.digitrax.com) for complete warranty details and instructions for returning items for repair.

**Please return warranty items directly to Digitrax - DO NOT** return items to place of purchase.



DN166I2

Fits InterMountain N Scale FP 7 units

# Go Beyond DCC With Digitrax® Complete Train Control

## Main Station

Starter Sets  
LocoNet®  
Power Supplies



Your Digitrax LocoNet® Starter Set is just the beginning of an exciting trip! Pick the one that's right for you!



LocoNet®  
The Digitrax  
Difference

## Locomotive Shops

Mobile Decoders  
Function Decoders  
SoundFX™ Decoders

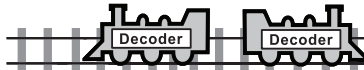

## More Fun For Everyone

Add More Boosters, Advanced & Simple Throttles, Power Supplies, Universal Panels, IR and/or Radio for more trains and operators.

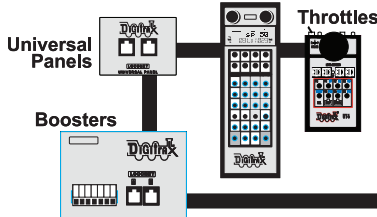

## Maintenance Of Way

Make your layout more fun & simpler to operate!

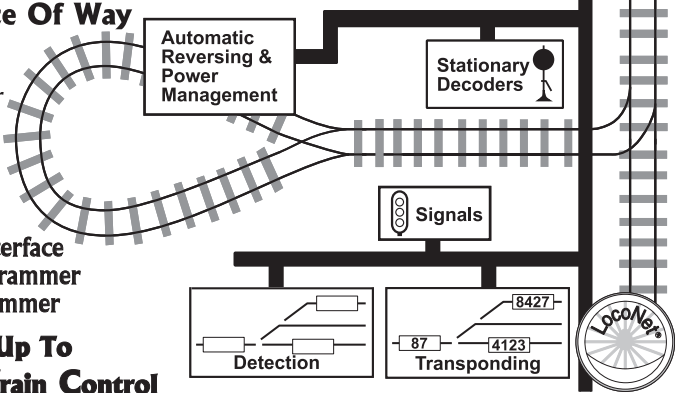

## Computer Controls

Computer Interface  
Decoder Programmer  
Sound Programmer

## It All Adds Up To Complete Train Control



Made in the USA

Part 15, Class B  
RFI Compliant



2443 Transmitter Road  
Panama City, FL 32404

[www.digitrax.com](http://www.digitrax.com)

Contact: [www.digitrax.com/contact](http://www.digitrax.com/contact)

Support: [techsupport@digitrax.com](mailto:techsupport@digitrax.com)

Repair: [repair@digitrax.com](mailto:repair@digitrax.com)

DN166I2



6 52667 05089 0