



**Complete
Train
Control**



Digitrax Command Control Starter Set Manual

Includes:

**DCS51 All In One
Command Station Booster Throttle,
PS314 Power Supply,
LT1 LocoNet Cable & Decoder Tester**



**Digitrax, Inc.
2443 Transmitter Road
Panama City, Florida 32404
(850) 872 9890 - Fax (850) 872 9557
www.digitrax.com**

Digitrax Manuals & Instructions are updated periodically.
Please visit www.digitrax.com for the latest version of all manuals. This
manual was updated 12/1/2012.

DIGITRAX ZEPHYR XTRA SET MANUAL

Table of Contents

1.0 Introduction	4
1.1 Zephyr Xtra Components	4
2.0 Quick Start Guide	4
2.1 Unpacking Your Zephyr Xtra	4
2.2 Before You Begin	5
2.3 Connecting the Pieces	5
2.4 Turn on Track Power	6
2.5 Select & Run Non-DCC Locomotives	7
2.6 Select & Run DCC Equipped Locomotives	8
3.0 Preparing Your Locomotives	9
4.0 Preparing Your Layout	9
5.0 DCS51 Front Panel Controls And Indicators	9
6.0 DCS51 Display	11
7.0 Hooking Up Your Zephyr Xtra	12
7.1 Zephyr Xtra Rear Panel Connections	12
7.2 Connecting the Zephyr Xtra	13
8.0 Run a Locomotive Without a DCC Decoder	14
9.0 Run a DCC Equipped Locomotive	15
9.1 DCC Decoder or Address Basics	15
9.2 Selecting and Running your DCC Locomotive	16
9.3 Using the RECALL Key	17
10.0 Locomotive Direction Control	18
11.0 Shutting Down the System	18
12.0 Resuming Operation	18
13.0 Troubleshooting Basic Operation	19
14.0 Locomotive Speed Control	20
14.1 Speed Limit	20
15.0 Stop and Emergency Stop	20
15.1 Setting a Loco to Zero Speed	20
15.2 Brake Operation	20
15.3 Emergency Stop	21
16.0 Programming & Reading Your Decoder	22
16.1 Setting Up a Programming Track	22
16.2 Changing & Reading the Decoder Address	24
16.3 Programming Configuration Variables Other Than Addresses	25
16.4 Programming On The Mainline: Operations Mode Programming	27
16.5 Programming Error Messages	28
16.6 Reading Back CV Values	28

16.7 Configuration Variable (CV) Programming Notes:	29
17.0 Functions	30
17.1 Controlling Functions F0-F9	30
17.1.1 Function 0 (F0) Headlights Forward and Reverse	30
17.1.2 Functions 1, 4, 5, 6, 7, 8 & 9	30
17.1.3 Function 2 (F2) Momentary Operation	30
17.1.4 Function 3 (F3) Standard or Momentary Operation	31
17.1.5 MUTE Function Key (F8)	31
17.1.6 Functions 10 through 19 (F10 - F19)	32
17.1.7 Functions 20 through 28 (F20 - F28)	32
17.2 Troubleshooting Function Operation	32
18.0 MU (Multiple Unit) Operations.....	32
18.1 Adding a Locomotive to an MU	33
18.2 Removing a Loco from an MU.....	35
18.3 MU of Mismatched Locomotives.....	35
18.4 Controlling Functions On MUed Locomotives	35
19.0 Stealing: When an Address Is Running on Another Throttle.....	36
20.0 Releasing an Address From a Throttle	37
20.1 Dispatching Addresses or MUs.....	37
21.0 The FuLL Message	38
22.0 DCS51 Error Messages.....	39
23.0 Decoder Speed Step Settings	40
23.1 Changing Speed Step Settings: Status Editing	40
24.0 SWITCH Mode	41
24.1 Saving the last Switch states or settings for your current DCS51 session. 42	
25.0 Adding Throttles: LocoNet & Jump Ports.....	43
25.1 Adding LocoNet Throttles To Your DCS51	43
25.2 JUMP Ports: Using a Smooth DC Power Pack As an Additional Throttle 43	
25.3 Adding Another DCS51 to your layout	47
25.3.1 Assigning Throttle Identities	48
25.3.2 Making LocoNet Cables	50
25.3.3 Testing LocoNet Cables with an LT1	50
26.0 Clearing the System	51
27.0 Troubleshooting General	52
27.1 Nothing is responding.....	52
27.2 No Power or Intermittent Operation.....	52
27.2.1 The Quarter Trick.....	52
27.2.2 The LT1 Tester	52
27.3 Emergency Stop	52
27.4 Mechanical Drive Train Problems	52
27.5 “Strange” Locomotive Lights	52
27.6 Decoder Won’t Respond	53

27.7 I'm totally lost!	54
27.8 DCS51 Shutdown	54
28.0 DCS51 Option Switch Setup	54
29.0 LocoNet: The Digitrax Difference	56
29.1 System Architecture	56
29.2 System Expansion	56
30.0 FCC Information.....	57
31.0 Digitrax 'No Worries' Warranty & Repair	58
Specifications	59
Notes.....	60
Index.....	62

Digitrax, the Digitrax Train Logos, LocoNet, Super Empire Builder Xtra, Super Chief Xtra, Transponding, SuperSonic, AutoReversing, Zephyr Xtra, Jump & others are trademarks of Digitrax, Inc. This manual may not be reproduced in any form without permission.

1.0 Introduction

Congratulations on your purchase of a Digitrax Zephyr Xtra Starter Set! Your success with and enjoyment of our products are very important to us. After all, this is a hobby and it is FUN!!! Refer to the Quick Start Guide that came with your system or follow the steps in the sections below to get up and running right away. Please read this manual to learn more. We have included lots of hints and operating ideas based on our experience. The Zephyr Xtra is designed for easy operation and expandability with Digitrax LocoNet. With LocoNet, just plug in system components to build the layout control system that you've always wanted! If you have questions not covered by this manual please contact your dealer or Digitrax technical support.

1.1 Zephyr Xtra Components

Your Zephyr Xtra Starter Set contains:

DCS51 All-in-one command station, throttle and booster to run your layout

PS314 Power supply to provide power to run your DCS51

LT1 Decoder and LocoNet Cable Tester

Quick Start Guide - To get you up and running

Zephyr Xtra Manual - System Reference Manual

Digitrax Decoder Manual - Reference for Digitrax Decoders

2.0 Quick Start Guide

2.1 Unpacking Your Zephyr Xtra

Unpack your box and locate the **DCS51 Command Station** and the **PS314 power supply**.

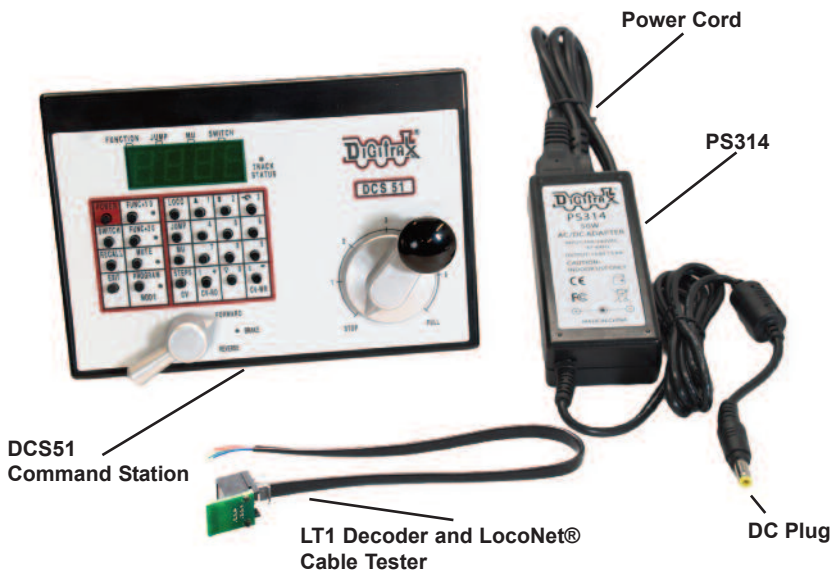

2.2 Before You Begin

Before proceeding to the next step, make sure the **Throttle Knob** is turned all the way to “**STOP**” and the **Direction/Brake** lever is set to “**BRAKE**”

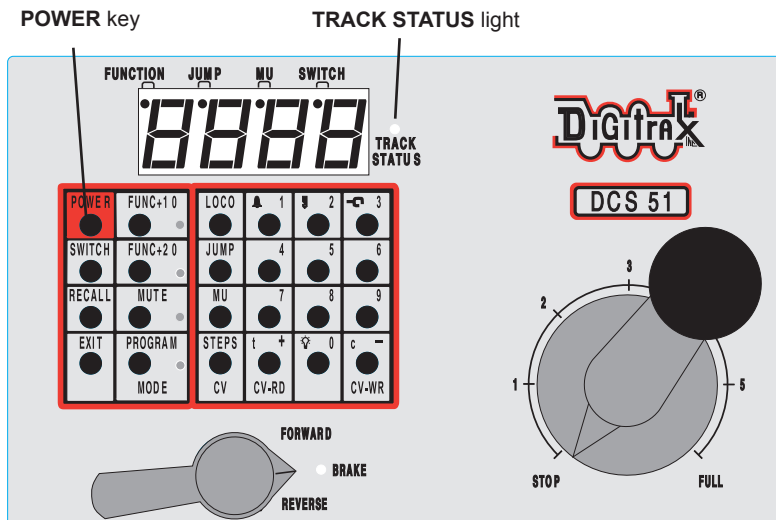

2.3 Connecting the Pieces

On the back of the **DCS51**, locate the gray screw terminal strip.

On this strip, locate the two terminals labeled “**RAIL A**” and “**RAIL B**”. Attach your layout track wires to these terminals.

It does not matter which is which. Find the jack on the back of the **DCS51** marked “**POWER IN, 13.8 V DC, 3.5 AMPS**” Plug the **PS314** DC plug into this jack and then connect the **PS314** into an AC outlet that matches the power cord on the **PS314**. The **PS314** will work universally on 110 through 240V AC

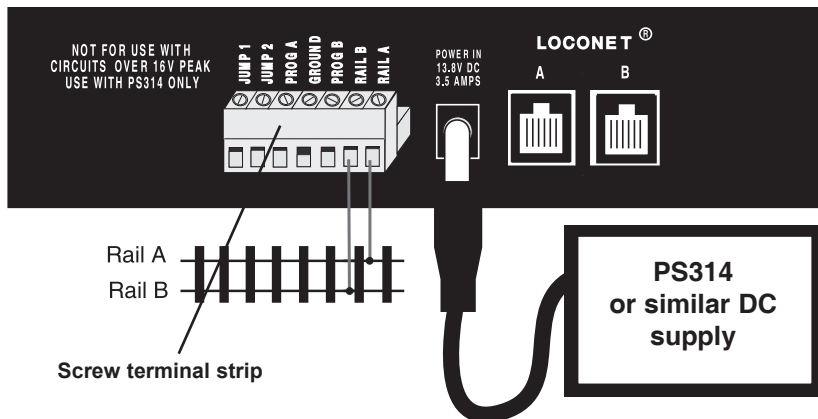

2.4 Turn on Track Power

1. On the front panel of the **DCS51**, locate the key marked “**POWER**” It is on the left hand column of keys.
2. When you push it, the orange “**TRACK STATUS**” light will come on.

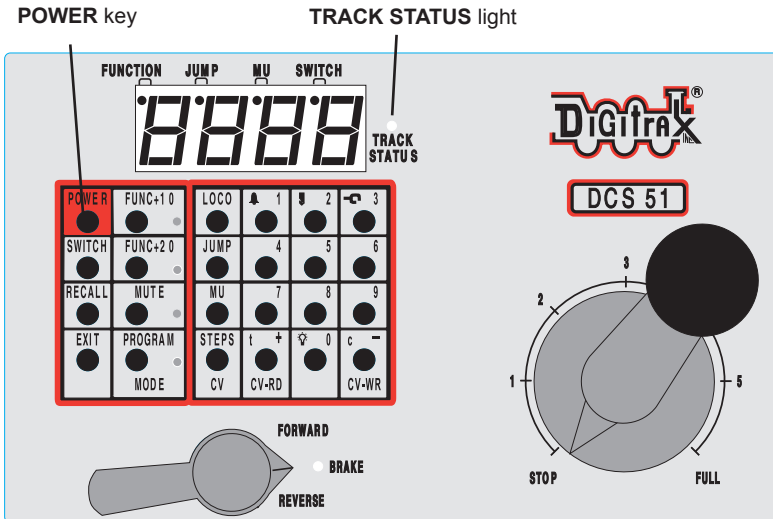

2.5 Select & Run Non-DCC Locomotives

1. To select a non-DCC equipped (Analog) locomotive to run, look at the main group of keys on the front panel. Locate the one labeled “LOCO”.
2. Press this key **ONCE**, enter “00” and press “LOCO” once again. You have selected a locomotive to run!
3. To run the locomotive, place the locomotive on your layout, move the **Direction/Brake** lever to either “**FORWARD**” or “**REVERSE**”, depending on which way you want the locomotive to move, and slowly turn the Throttle clockwise until the locomotive starts to move.
4. If your locomotive runs in the opposite direction of the throttle setting, turn the locomotive around.
5. To stop the locomotive, either turn the Throttle back to “**STOP**,” or shift the **Direction/Brake** lever to “**BRAKE**”.

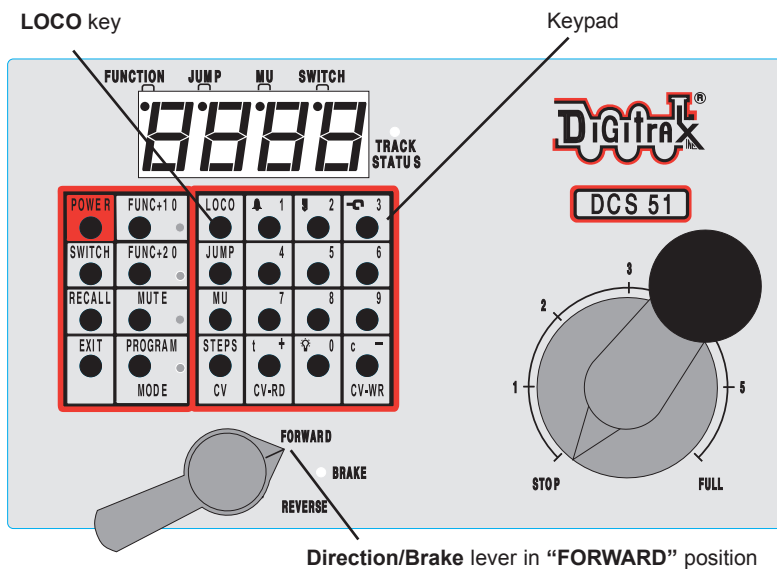

2.6 Select & Run DCC Equipped Locomotives

Most new decoders and DCC-equipped locomotives have their decoder address factory set to “03.” Other DCC-equipped locomotives may have had their address changed. To run a DCC-equipped loco, you must know its address. For detailed instructions on reading the address, see the section 16.2 Steps 1-4.

For now, let’s assume you are using a brand-new, DCC-equipped loco that is set to address “03.” To select this locomotive, press the key labeled “LOCO” ONCE, enter “03” on the keypad, and press “LOCO” once again. You have selected a DCC loco!

To run the locomotive, move the **Direction/Brake** lever to either ‘**FORWARD**’ or ‘**REVERSE**’, depending on which way you want the loco to move, and slowly turn the Throttle clockwise until the locomotive starts to move. To stop the loco, either turn the **Throttle** back to “STOP,” or shift the **Direction/Brake** lever to “**BRAKE**.”

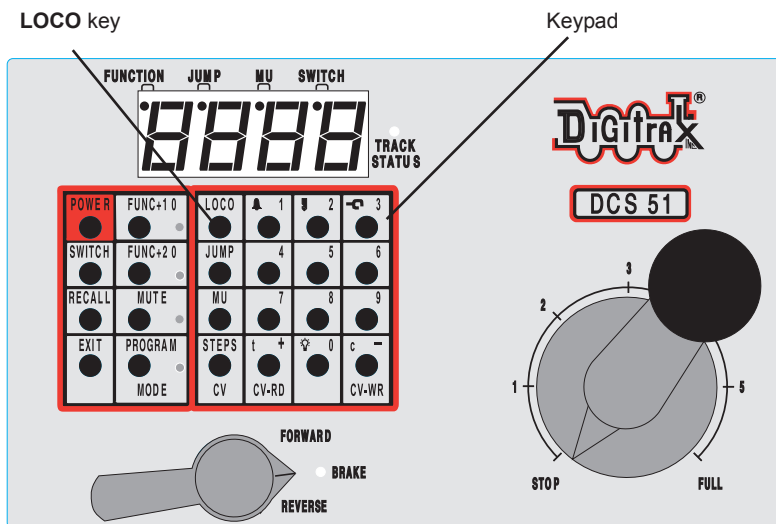

STOP HERE!

This is the end of the Quick Start Section of the manual. You should now be able to run both a DCC locomotive and a non-DCC locomotive at this point. Enjoy running trains for a few minutes before you dive in to the rest of the manual. The remaining sections of the manual go into more detail about the capabilities of the Zephyr Xtra. When you are ready to learn more, read on!

If you have trouble with any of the steps above, please refer to Section 13.0 Troubleshooting Basic Operation.

3.0 Preparing Your Locomotives

You will be able to run one locomotive without a decoder on your Zephyr Xtra system along with the ones with decoders. So, even if you don't have a loco with a decoder, you can still hook up your new system and try it out right away!

You will need to install decoders in the locomotives you want to run in order to take full advantage of your new Digitrax Command Control system. The decoder allows you to individually control each locomotive's speed, direction, lights and other functions. We don't include decoders with our starter sets because there are so many different decoders available for so many different locomotives. We want to be sure you don't spend money on a decoder that may not be the best choice for your particular locomotives. Your dealer can help you select the best decoder choices for your layout from Digitrax wide variety of decoders. Our web site www.digitrax.com contains information about decoder installations and which decoders are best for particular locomotives.

A Digitrax Decoder Manual is included with all Starter Sets so you will have it available to use with any Digitrax decoders you purchase.

4.0 Preparing Your Layout

Digitrax simplifies layout wiring for new layouts. If you already have a layout, you probably won't need to rewire to install your Digitrax Zephyr Xtra. Since the DCC signal travels with the power on the rails, you must have power to the track in all locations so that the decoders can receive the signal and respond to your commands. For more information about layout wiring visit our web site.

5.0 DCS51 Front Panel Controls And Indicators

Before you select and run a locomotive, take a few minutes to look at the DCS51's controls and display.

1. The **Throttle Knob** is the large silver and black knob on the right side of the DCS51. The **Throttle Knob** controls locomotive speed from **STOP** to **FULL** speed. Turn it clockwise to increase speed and counter clockwise to decrease speed.
2. The **Direction Control Lever** is the small silver lever (located on the left side of the DCS51) that controls the locomotive's direction of travel, **FORWARD** or **REVERSE**. This knob also controls the **BRAKE**.
3. When you have a loco address selected and the **Direction Control Lever** lever is in the **BRAKE** position, the **Brake Indicator Light** will blink until the loco stops and then remain on steady to let you know that the **BRAKE** is on. When you move the lever to **FORWARD** or **REVERSE**, the **Brake Indicator Light** will flash to let you know that the brake is released and the loco is accelerating to the speed shown on the **Throttle Knob**.
4. There are 24 **KEYS** on the DCS51's keypad, including a full numeric keypad for direct entry of numeric values. Some keys have more than one use

when used in combination with other keys or sequences of keystrokes.

5. The **TRACK STATUS Light** is lit when track power is on and unlit when track power is off. Track power must be on to operate the trains on the track. Simply press the **POWER** key to toggle between power on and off. If you need to stop the whole layout, press the **POWER** key to turn off track power and put everything on the layout into “**Emergency Stop.**”

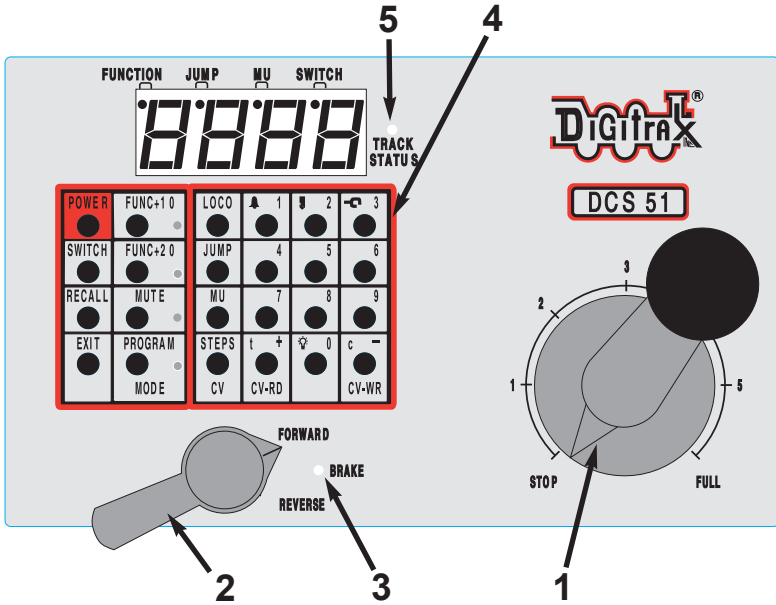

6.0 DCS51 Display

The DCS51's Display is made up of 4 digits/letters on the main part of the screen and 4 Indicator Dots across the top of the screen.

When you are running a locomotive, you will see the address of that locomotive in the display and the **Function Indicator Dot** will be lit. This means that the throttle knob will control speed, the direction lever will control direction and braking and the number keys will control the functions on the locomotive. You will see the following display if you are running loco address 1873 on your local throttle.

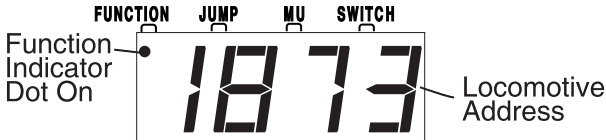

The Display has three additional Indicator Dots associated with more advanced features available on the DCS51:

The **JUMP Indicator Dot** lets you know if one or more Jump ports are active. See Section 25.2.

The **MU Indicator Dot** lets you know if Multiple Unit (MU) or consisting is active. See Section 18.

The **SWITCH Indicator Dot** lets you know when you are in switch mode for controlling turnouts or setting up system options. See Section 24 for turnout operation and Section 28 for Option Switch set up information.

7.0 Hooking Up Your Zephyr Xtra

7.1 Zephyr Xtra Rear Panel Connections

1. **RAIL A & B** for connecting the DCS51 to the rails on the layout.
2. **PROG A & B** for hooking up the programming track. Section 16.1.
3. **JUMP 1 & 2** for connecting one or two smooth DC power packs to the system for use as additional throttles. Section 25.2
4. **POWER IN**-plug in the PS314 here.
5. **LOCONET PORTS A & B** for connecting the DCS51 to other LocoNet devices for expanding your layout.
6. **YOUR LAYOUT**. You can connect Zephyr Xtra to most existing layouts.

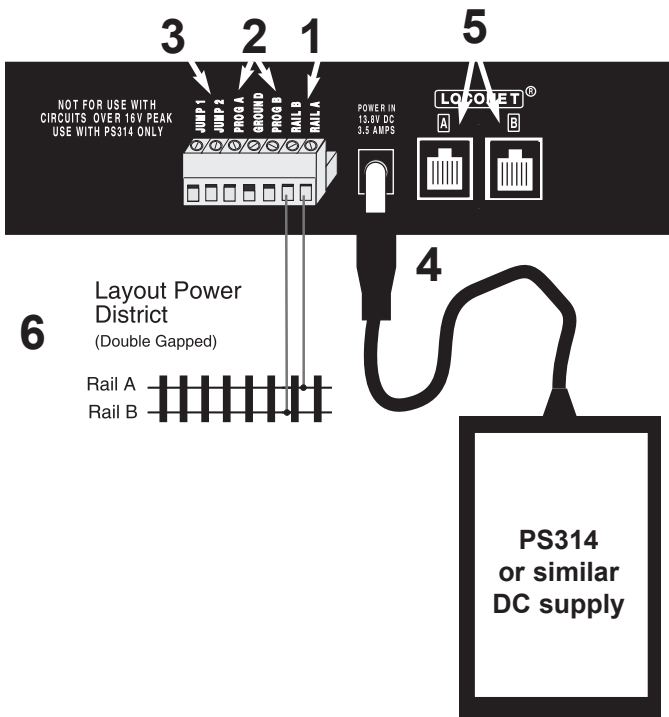

7.2 Connecting the Zephyr Xtra

These simple instructions will help you get up and running quickly. A full description of all controls and technical reference information are included later in this manual. This section assumes that you are using a new set straight out of the box.

1. Hook up the wires from the track to the **RAIL A & RAIL B** terminals on the DCS51. Insert the wire from one rail of the track into the **RAIL A** terminal on the back of the DCS51. Insert the wire from the other rail of the track into the **RAIL B** terminal. Turn the screw counter clockwise to open the connector and clockwise to close it once the wire is in place.
2. Plug the barrel connector from the PS314 into the **POWER IN** jack on the back of the DCS51. Plug the body of the PS314 in to a regular wall outlet.

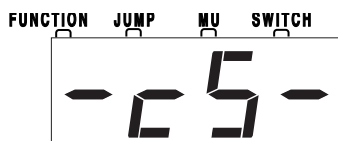

Once power is applied, the DCS51 will briefly flash “-cS-” to let you know it is running as a command station.

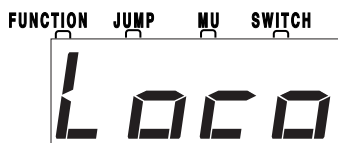

The DCS51’s display will change automatically to “Loco” or the last address that was on the throttle when you turned it off.

3. Turn track power on. Check the **TRACK STATUS Light**. If it is on, you are ready to go. If the **TRACK STATUS Light** is unlit, press the **POWER** key (located on the left side of the keypad) to turn track power on. When track power is on the **TRACK STATUS Light** will be lit.

The following examples will help you learn about your new DCS51. The first example shows how to select and run a locomotive without a DCC decoder. The second example shows how to select and run a DCC decoder equipped locomotive.

8.0 Run a Locomotive Without a DCC Decoder

In the proceeding steps you familiarized yourself with the controls and connected the Zephyr Xtra to your layout. Just follow these simple steps and you'll be running one of your existing DC locomotives in just a few more minutes.

1. Set the DCS51's **Throttle Knob** to **STOP**.
2. Place an analog locomotive, one without a decoder installed, on your layout that is controlled by your DCS51.
3. Check the DCS51's **TRACK STATUS Light** to be sure that track power is turned on. Press **POWER** to turn track power on if necessary.
4. Press the **LOCO** key to begin the selection process. The Display will begin flashing either "LOCO" or the last address selected on the throttle.

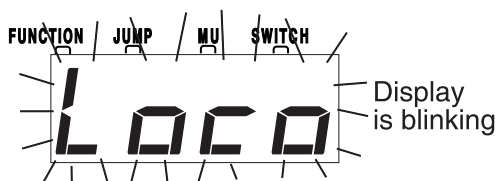

5. Use the numeric keypad to enter "00", the address used to control the locomotive without a decoder. Your display will show:

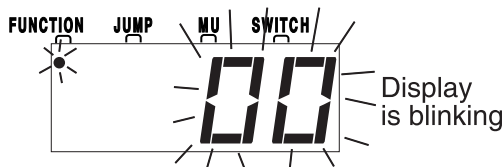

6. Press the **LOCO** key again to confirm your selection and set address 00 on the throttle. The display will stop blinking and you will have control of the analog locomotive.

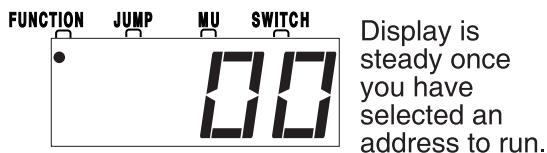

7. Set the **Direction Control Lever** to **FORWARD** and turn the **Throttle Knob** clockwise slowly to increase the speed of the analog locomotive. As the speed increases, the locomotive on the track will begin to move. The direction of an analog locomotive is determined by track polarity not by the DCC signal so, you may have to turn your analog locomotive around to match the direction of travel on the **Direction Control Lever**. The DCS51's

TRACK STATUS Light should slightly change color as you change the speed setting.

8. Change the **Direction Control Lever** to **REVERSE** and the loco will move in the opposite direction.
9. Change the **Direction Control Lever** to the **BRAKE** position and the loco will slow down and stop. Move the **Direction Control Lever** to **FORWARD** or **REVERSE** and the loco will move again.
10. Turn the **Throttle Knob** to **STOP** and the loco will stop moving.
11. If you have a headlight installed in your loco, it will be on and stay on because with DCC there is constant power to the track.

A locomotive without a DCC decoder is called an **analog locomotive**. While an analog locomotive, without a decoder, is sitting still on your digital layout, you will hear a “singing” sound. This is caused by the DCC track signal when it is applied to an analog locomotive. Once the analog locomotive is moving, this sound will change and be less noticeable. To avoid heat build up in your locos without decoders, Digitrax recommends that analog locos **NOT** be left sitting on DCC powered track for long periods of time when they are not running.

Address 00 is reserved for running an analog locomotive. Your analog locomotives will not run with any other address. As with a regular DC system, only one analog locomotive can be controlled at a time. If you try to run more than one analog locomotive at the same time on the layout all of the analog locos will respond to the commands sent to address 00. By adding DCC decoders to your locomotives and additional throttles to your system, you can individually control up to 20 locomotives at the same time with your Zephyr Xtra Set.

9.0 Run a DCC Equipped Locomotive

9.1 DCC Decoder or Address Basics

1. Each DCC decoder can be assigned a unique DCC decoder address that is used by the system to send commands to that decoder. The address is a numeric value remembered by the decoder in the loco until you change it.
2. You program each of your locomotives with its own unique address so that you can run them independently.
3. To select a DCC locomotive and run it, you must know its address.
4. Digitrax decoders are set up at the factory with address 03. This means that when you take a Digitrax decoder out of the package and install it in your loco, you can select address 03 on your throttle and run the decoder. You can easily change this address by following the instructions in Section 16.2. To make the examples easier to follow, let's leave everything at the factory settings for now.

-
-
- If you do not know the address of the DCC locomotive you want to run, you can either read back the decoder's address or program it to the address you want to use. Section 16.6 shows how to read back the decoder address.

9.2 Selecting and Running your DCC Locomotive

To select and run a DCC equipped locomotive with a known address follow these steps:

- Set the DCS51's **Throttle Knob** to **STOP**.
- Place a DCC equipped locomotive (one with a decoder installed) on your digital layout that is controlled by your DCS51. In this example we assume that you have a new Digitrax decoder that is factory programmed to address 03. If your decoder is using a different address, simply use that address as you follow these instructions.
- Check the DCS51's **TRACK STATUS Light** to be sure that track power is turned on. Press the **POWER** key to turn track power on if necessary.
- Press the **LOCO** key to begin the selection process. The Display will begin flashing either "Loco" or the last address selected on the throttle. If you are continuing on from the previous example of running an analog locomotive, your display will be blinking address 00 as shown here since 00 was the last address you used:

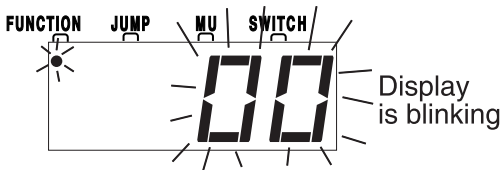

- Use the numeric keypad to enter "03", the address used to control the locomotive with the decoder. Your display will show:

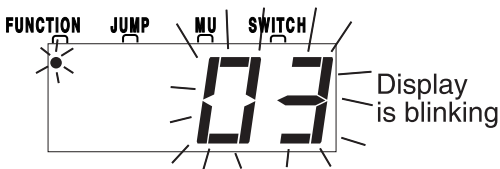

- Press the **LOCO** key again to confirm your selection and set address 03 on the throttle. The display will stop blinking and you will have control of the DCC equipped locomotive with address 03.

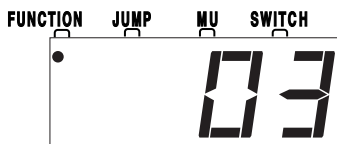

Display is steady once you have selected an address to run.

7. Set the **Direction Control Lever** to **FORWARD** and turn the **Throttle Knob** clockwise slowly to increase the speed of the locomotive. As the speed increases, the locomotive on the track will begin to move forward. The direction of digital locomotives is determined by the DCC signal so, forward means that the loco will move in the direction the decoder is set up to recognize as forward.
8. Change the **Direction Control Lever** to **REVERSE** and the loco will move in the reverse direction.
9. Change the **Direction Control Lever** to the **BRAKE** position and the loco will slow down and stop. Move the **Direction Control Lever** back to **FORWARD** or **REVERSE** and the loco will move again.
10. Turn the **Throttle Knob** to **STOP** and the loco will stop moving.
11. If you have a headlight installed in your loco, press the **LAMP/0** key to toggle between lights on and off. Many DCC-ready locomotives have directional lighting installed, with headlight/back-up light operating depending on direction of travel of the locomotive. If you have other functions installed in your loco, you can operate them by pressing the associated number key for the function you want to operate. You must have sound capability installed in your locomotive in order to operate the sound functions (**BELL/1** and **WHISTLE/2** keys and others).

9.3 Using the RECALL Key

The Zephyr Xtra's **RECALL** feature allows you to change control among recently used addresses without the need to re-enter the address each time. The factory default is a 2 address recall stack which allows you to switch quickly between the last two loco addresses that you used. You can increase this to 4 or 8 entries, see below for instructions.

1. To switch control from the loco address currently in use to the last address used, press the **RECALL** key. The display will bring up the previously used address.
2. Press the **RECALL** key to cycle through the addresses available for recall. Each address will appear in the display and be flashing indicating that it is available for selection.
3. When the loco address you want to control appears in the display, press the **LOCO** key to begin controlling that address.

To change to a 4 address stack, change OpSw10 to closed and OpSw11 to thrown

To change to an 8 address stack, change OPSW11 to closed.

To change to a 2 address recall stack set both OpSw10 & OpSw11 to thrown (this is the factory default setting). See section 28.0 for option switch set up instructions.

10.0 Locomotive Direction Control

Move the **Direction Control Lever** to **FORWARD** or **REVERSE** to change the direction of the loco address running on the throttle. To determine the direction of a loco that is not moving, simply look at the position of the lever. You can move the lever quickly past the **BRAKE** position with no adverse effects.

If you change direction while a loco is moving it will slow down to 0 speed and then speed up to the commanded speed according to the decoder's programmed CV values for deceleration and acceleration.

11.0 Shutting Down the System

When you are finished with your session, you should shut down the DCS51 by turning off power to the system.

1. Bring all locomotives on the layout to a stop by setting set the **Throttle Knob** for each loco to **STOP**.
2. Turn track power off: Press the **POWER** key, the DCS51's **TRACK STATUS Light** will go off. The display will briefly display "Po" followed by two characters, the Po means power off, the two characters indicate which software version is installed in the unit. The display will automatically revert to showing the last loco address selected on the throttle but since track power is now off, it will not run the layout until you turn on track power again.
3. Unplug the PS314 power supply from the wall outlet.

When power is restored to the DCS51, it will "wake up" with all of the settings as they were left when powered down. The power to the command station can be left on all the time if desired.

12.0 Resuming Operation

When you are ready to run trains again:

1. Set the DCS51's **Throttle Knob** to **STOP**.
2. Plug in the PS314 power supply to the wall outlet and to the DCS51.
3. Press the **POWER** key to turn on track power. The **TRACK STATUS Light** will light up.
4. The DCS51 display will show the last locomotive address you were running and be ready to begin right where you left off.

If you have trouble with any of the steps above, please refer to Section 13.0 Troubleshooting Basic Operation.

13.0 Troubleshooting Basic Operation

If you encountered problems at any step in this Quick Start Section:

1. Try backing up a step until you get results described. The steps included in this installation procedure are set up so that if you follow them carefully, any problems you encounter will be easy to isolate and correct.
2. If you still have problems or if you have other questions, we encourage you to call, fax or e-mail your favorite Digitrax dealer. If your dealer is not able to help, please contact Digitrax techsupport directly.

There are thousands of successful Digitrax installations around the world and we want to be sure that yours is one of them.

Notes for users of decoders without 128 speed step capability:

Some non-Digitrax decoders are not able to run in 128 speed step mode. Digitrax decoders are capable of 128 speed step control but can be programmed otherwise.

1. The DCS51 command station operates in 128 speed step mode. If you are using a locomotive with a decoder that does not have 128 step capability you will have to adjust either the decoder or the DCS51 so that both are using the same number of speed steps to communicate. We call this procedure **status editing**. You can status edit each individual decoder (see Section 23) or you can change the DCS51's system default by setting the DCS51's Option Switches 21-23 and run all of your decoders with fewer speed steps to accommodate these decoders (see Section 28).
2. If you can't control the operation of the lights in your decoder equipped locomotive with the DCS51, be sure that the decoder itself is programmed to run in 128 speed steps.

What's Next?

Now that you have successfully set up and run your Zephyr Xtra Set, it's time to learn more about the features and options it has to offer.

Please read the manual and take time to understand and master each topic. Your Zephyr Xtra Set is the gateway to all the possibilities and options offered by Digitrax and LocoNet so the best advice is to take it step by step and don't try to do everything at once.

14.0 Locomotive Speed Control

To control the speed of a locomotive:

1. Select the loco address on the throttle.
2. Turn the **Throttle Knob** clockwise to increase speed and counterclockwise to decrease speed.

14.1 Speed Limit

You can limit top speed on any locomotive controlled by the DCS51. This feature is very useful if you are running your layout with young children who want to make the trains GO FAST!!! By setting a reasonable speed limit on the throttles used by the children, everyone can have more fun with the trains.

To set a “speed limit” for your DCS51’s local throttle follow these simple steps:

1. Press the **PROG** key. The display shows the last programming mode used.
2. Press the **MU** key. The display shows “id00”.
3. Press the **MU** key again. The display shows SPXX where XX is the current speed limit set for this DCS51. We recommend a value in the range of 26 (lowest speed limit) to 99 (full speed limit). DCS51 is shipped from the factory set for SP99.



4. Use the keypad to enter the new speed limit for the throttle.
5. Press the **EXIT** Key to set the selected speed limit and resume operation.

Once you set this speed limit, it will be in effect for **this specific DCS51’s local throttle** until you change it. Setting the speed limit will **not** affect any Jump™ Throttles or other throttles that are in use.

15.0 Stop and Emergency Stop

15.1 Setting a Loco to Zero Speed

To immediately stop a locomotive:

Make sure the loco address is selected on the throttle and turn the **Throttle Knob** counterclockwise until it is in the **STOP** position. The loco should slow to a stop as you rotate the throttle knob. This lets you slow down your loco and stop it prototypically. If you have set up deceleration (CV4) for the loco and you move the throttle knob to **STOP**, your loco will slow down and come to a stop at the programmed deceleration rate.

15.2 Brake Operation

To use the pre-set braking rate to stop and start a locomotive:

Move the **Direction Control Lever** to the **BRAKE** position, the **Brake Indicator Light** will begin blinking and the loco will slow down to a stop at the brake rate you have set up in the DCS51. As the loco slows to a stop, the **Brake Indicator Light** will change from blinking to steady on to let you know that the brake is on.

Move the **Direction Control Lever** to the **FORWARD** or **REVERSE** position and the loco will accelerate at the programmed brake rate to the speed on the throttle knob. As the loco accelerates, the **BRAKE Indicator Light** will flash during acceleration and go off when the loco has reached the speed set on the **Throttle Knob**.

The DCS51 is shipped with the brake rate set at 02. This gives a small amount of deceleration when the brake is applied and a small amount of acceleration when the brake is released.

To change the brake rate:

1. Press the **PROG** key. The display shows the last programming mode used.
2. Press the **MU** key. The display shows id00.
3. Press the **MU** key again. The display shows SPXX where XX is the current speed limit set for this DCS51.
4. Press the **MU** key again. The display shows brXX where XX is the current brake rate set for this DCS51.

Use the keypad to enter the new brake rate for the



DCS51. Setting brake rate at 00 turns the brake feature off. A setting of 01 gives a fast braking (deceleration rate) and startup (acceleration rate) effect and a setting of 15 gives the slow braking (deceleration rate) and startup (acceleration rate) effect when the brake is used.

5. Press the **EXIT** key to set the new braking rate and return to normal operation.

NOTE: Changing the brake rate only affects the locomotive controlled by the DCS51 throttle. It does not affect the the decoder programming.

Braking can also be handled on a loco by loco basis if you set up each decoder with acceleration and deceleration rates that simulate the scale effects of braking the train. Then when you command an instant reverse, the system will simulate braking by slowing down the locomotive at the programmed deceleration rate, come to a stop and then accelerate at the programmed acceleration rate in the opposite direction.

15.3 Emergency Stop

To stop *everything* on the layout immediately:

Press the **POWER** key to turn off power to the whole layout. This option will stop everything on the layout. Do not turn Track Power off during a short. Clear the short first. The Zephyr Xtra shuts off when it sees a short to protect itself.

Having Trouble Stopping? If the deceleration CV value you set for a particular loco is very large, this can make it look like the loco is not stopping on command because the deceleration CV value is causing the loco to take a long time to come to a stop.

16.0 Programming & Reading Your Digitrax Decoders

Your DCC Decoders have many different **configuration variables** (CVs for short) that let you set up a different set of characteristics for each decoder installed in a locomotive. When you want to change a loco's address, set up how its lights work, change its momentum characteristics, etc. you will program new CV values into the appropriate CVs to set it up just the way you want.

Each CV controls a characteristic of the decoder. See your decoder manual for a list of the most commonly used CVs and their meanings. A Digitrax Decoder Manual is included as a part of your Zephyr Xtra system. Each decoder comes pre-programmed with factory settings that will let you run it right away. We recommend that you use the factory settings until you are comfortable with running your layout with Digital Command Control. ***If you are using non-Digitrax decoders or sound decoders, please consult the manual provided by the manufacturer for how CV's are used and programming instructions.***

The factory set address for all Digitrax decoders is 03. This is the first CV you will want to change because it is not very useful to have all of your locos respond to the same address.

Decoders are programmed when the command station sends programming information to them through the rails. Your DCS51 supports two types of programming:

Service Mode Programming is done on an electrically isolated programming track. Using this mode, the command station broadcasts programming information to all decoders on the program track. Because this is a broadcast mode, you must isolate the decoder you want to program from the others on the layout by using a separate programming track that is connected to the command station for programming but not powered for operation of the locomotive. This mode works with all DCC decoders. This is the most commonly used programming method.

Operations Mode Programming is done on the layout by sending programming commands to a specific locomotive address while they are powered on the mainline or main layout track. To use this mode, you must have decoders that are capable of operations mode programming. The programming track is not used when using ops mode programming.

16.1 Setting Up a Programming Track

Your DCS51 has two sets of DCC outputs. This means that you will be able to program decoders using one set of DCC outputs while the layout is running on the other set of DCC outputs. When you hooked up your DCS51 to the layout, you used the **RAIL A & RAIL B** connections to the track. Now we will use the **PROG A & PROG B** outputs to set up a programming track.

NOTE: The programming track is powered for programming only and cannot run locomotives. You will have to manually move your locomotive on to the track whether using the siding or isolated track programming setup.

DCS51 Rear Panel Programming Track Hook Up Diagram

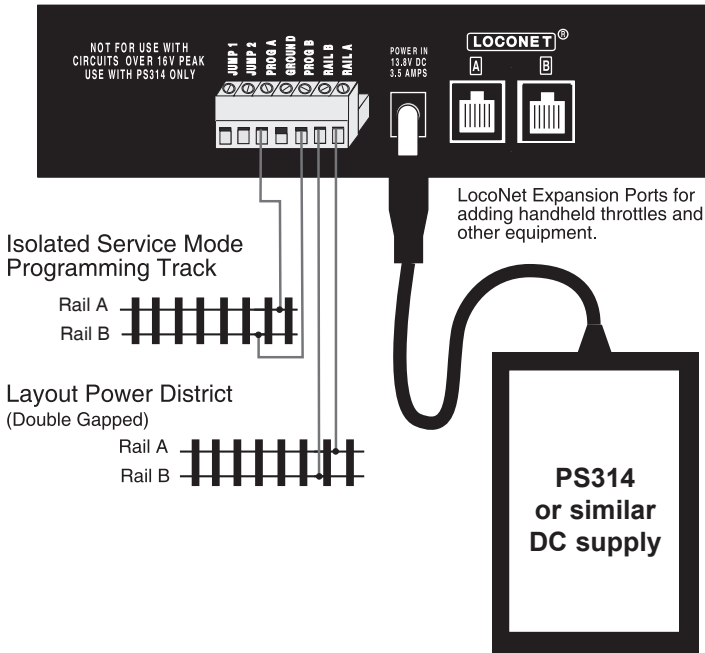

Your programming track can be as simple as a spare piece of track not connected to the layout as shown above or it can be a double gapped section of track connected to the DCS51's **PROG A & PROG B** outputs as shown below.

Programming Track Example Diagram

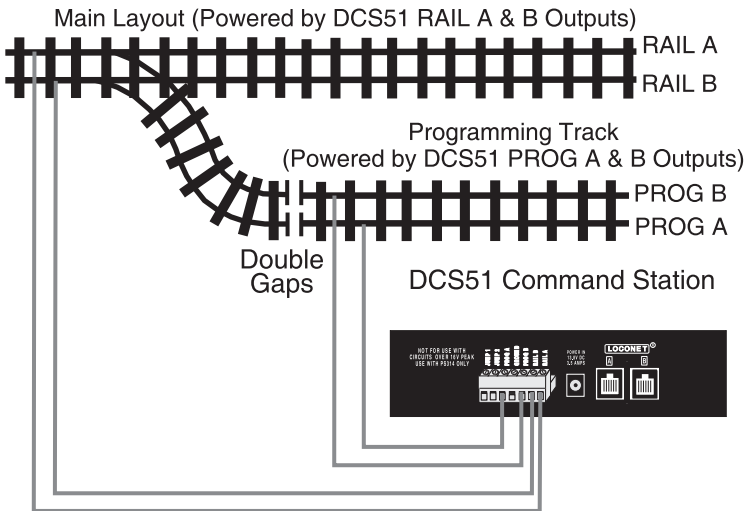

NOTE: Some wiring omitted for clarity

16.2 Changing & Reading the Decoder Address

1. Be sure that only the locomotive you want to program is on the programming track if you use Direct, Paged or Physical CV programming.
2. Press the **PROG** key on the DCS51 to enter programming mode. The DCS51 will display one of the programming modes available. Digitrax recommends the Direct Mode when you are using the programming track. If you press the PROG key repeatedly, you will cycle through the following programming choices: dir, OPS, PAGE, PHYS. See **Table 1** for display sequence.

Once the mode you want to use is on the screen you can go to step 3.

For example, to use Direct mode stop pressing the **PROG** key when the following screen appears:

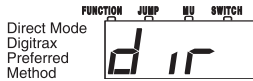

If you are not using Direct programming, see Table I: DCS51 Programming Display Table at the end of Section 16.3 for information about how your display will be different from this example.

3. Press the **LOCO** key and you will see either Ad2 or Ad4 in the display.
Ad2 = two digit address (address must be between 01-127)
Ad4 = four digit address (address must be between 0128-9983)

Each time you press the **LOCO** key the display will toggle between Ad2 and Ad4. When the one you want to use is in the display move to the next step.



Two Digit Address



Four Digit Address

4. Press the **CV-RD** key to to read back the address programmed into the decoder. Your display will show Ad2 or Ad4 while it is reading then it will display the decoder's currently programmed address.

When reading back addresses, 2 digit addresses are displayed with 3 digits, (001 through 127) and 4 digit addresses are displayed with 4 digits (0128 through 9983). Address 00 is reserved for analog locomotive operation.

For example, if 03 is the two digit address, the read back display will show:



Two digit address 03.

If 268 is the four digit address, the read back display will show:



Four digit address 268.

5. To change the address of the loco, press the **LOCO** key to choose Ad2 or press the **LOCO** key again for Ad4. Enter the address number you want to use for the loco, using 1 through 127 for a two digit address (AD2) and 128-9999 for a four digit address (AD4).

HINT: Many operators use the locomotive number or the last two digits of the number for the decoder/locomotive address.

- Press the **CV-WR** key to write the address to the decoder. The display will flicker while the address is programmed and then will show the new address in the display.

For example, to change the address from the two digit address 03 to the two digit address 96, press the **LOCO** Key until Ad2 appears in the display then use the key pad to enter **96** and press the **CV-WR** key to write the address.

- When you are finished programming the address, press the **EXIT** key. You are now ready to resume normal operations or proceed to programming other configuration variables.

For convenience the DCS51 will automatically return to the last Programming mode and CV number when programming is used the next time.

16.3 Programming Configuration Variables Other Than Addresses

There are many different CVs that have been defined to control the operating characteristics of your locomotives. Your decoder manual has a complete listing of CVs that are available in specific decoders, what they do and suggested values for each CV. Programming these CVs is simple:

- Be sure that only the locomotive you want to program is on the programming track (if using Operations mode the loco will need to be on the main-line).
- Press the **PROG** Key to enter programming mode. The DCS51 will display one of the programming modes available. Digitrax recommends the Direct Mode when you are using the programming track. As you press the **PROG** Key repeatedly, you will cycle through the following choices:
dir, OPS,PAGE, PHYS,

Once the mode you want to use is on the screen you can go to step 3.

For example, to use Direct mode stop pressing the **PROG** Key when the following screen appears:

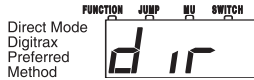

- Press the **CV** Key and you will see P followed by the last CV number used by the DCS51. The "t" indicates that you are in Direct programming mode.



- Enter the CV number you want to program. For example, if you want to set up acceleration which is controlled by CV03, use the keypad to enter **3**.



- Press the **CV-RD** key to read back the data value currently programmed into the decoder for the CV selected. Your screen will show something like this:



The numbers will flash for a few seconds as the DCS51 command station reads back the data value in the decoder. The “d” means that you are looking at the CV’s data value that is programmed into the decoder, in this case the CV value is 0.

- Use the numeric key pad to enter the new CV data value you want to program into the decoder. For example if you want to program the value of 2 for CV03 which controls acceleration, enter **2**.

Note: If you do not want to read back the CV’s data value as described in step 5, you can simply press the CV Key again to go directly to the data entry mode. In this case, the display will show “d” followed by 3 digits. When you see this display, use the key Pad to enter the new data value you want to program.

- Press **CV-WR** to write the new data value selected to the CV. The display will show the data value programmed.
- To program another CV, press the **CV** key and enter the CV number you want to program next and repeat steps 3-7 again.
- When you are finished programming, press the **EXIT** key to resume normal operations.

TABLE I: DCS51 Programming Display Table

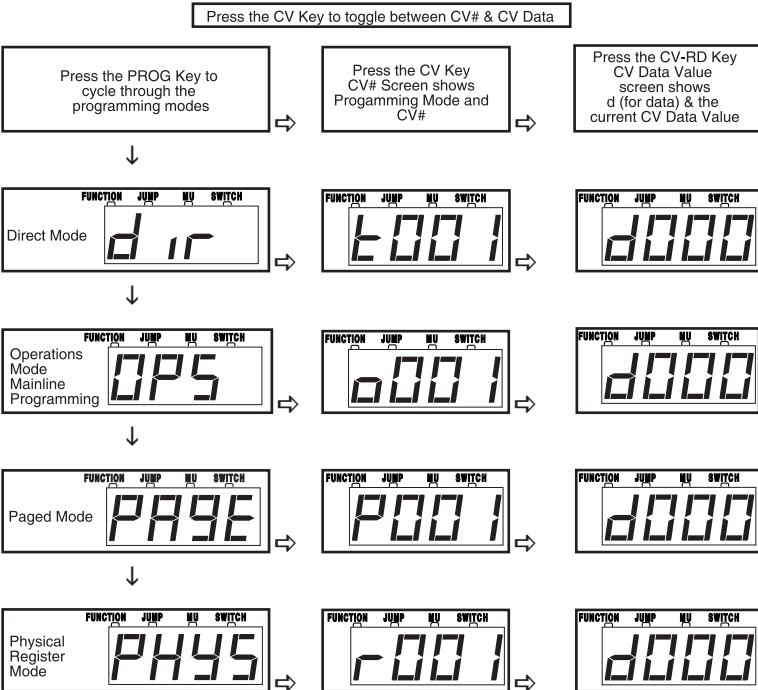

If you are using a programming mode other than Direct mode see Table 1 for the meanings of the screens you will see.

16.4 Programming On The Mainline: Operations Mode Programming

Operations (OPS) Mode Programming lets you program CVs in DCC locomotives equipped with Extended Packet Format decoders while they are on the mainline. A typical use for OPS mode programming would be to change the acceleration rate (CV03) or the deceleration rate (CV04) of your locomotives to simulate the weight and braking capability of the train to compensate for changing the number of cars or power units on a train.

Your DCS51 can use OPS Mode Programming to change the CV value in ANY CV, including 2 digit and 4 digit addresses, but some decoders may not accept changing these CV's in Operations mode.

OPS mode programming can be performed by any DCS51 or other LocoNet throttle, such as DT402, DT300, UT1, etc., at any time since the throttles are not competing for usage of the single programming track.

How to use Operations Mode Programming:

1. Place the loco you want to program on the layout.
2. Select the address of the decoder that you want to program on the local throttle of the DCS51. The decoder must be capable of operations mode programming.
3. Press the **PROG** key until OPS appears in the display.



4. Press the **CV** key and use **KEY PAD** to enter the CV you want to program. For example, to program the deceleration rate, enter **03** for CV03 which controls acceleration. Your display will look something like this:



5. Press the **CV** key again and use the key pad to enter the value you want to program for the CV you selected in the previous step. For example to set the acceleration rate to a value of 6, enter **6**. Your display will look like this:



6. Press the **CV-WR** key to write the data value to the selected CV.
7. Press the **EXIT** key when finished programming to return to normal operations.

NOTE: OPS Mode Programming on most systems is write only. OPS mode read back requires Digitrax compatible transponding decoders and transpond-

ing detectors on the layout in order to provide the two way communication required for OPS Mode read back.

16.5 Programming Error Messages

When you are programming decoders, there are a few error messages you may encounter.

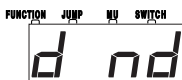

d nd means there is an open circuit on the programming track and no current draw is detected by the programmer.

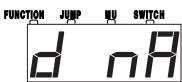

d nA means there is no acknowledgement from the decoder typically during decoder write operations.



d nr means the DCS51 was not able to read the decoder.

There are many causes for these error messages but most can be solved by checking the following:

1. Be sure the programming track is connected properly to the DCS51.
2. Be sure a decoder is correctly installed in the locomotive with all motor and pick up connections made correctly.
3. Be sure the loco with decoder correctly installed is making electrical contact with the programming track and that it remains in contact with the programming track until programming is complete.
4. Be sure there is not too much current draw from lamps and other loads from the locomotive that is being programmed.
5. Be sure the decoder you are programming supports the programming mode you are using. Not all decoders support all programming modes.

16.6 Reading Back CV Values

Your DCS51 can read back the CV data values programmed into your decoders. Most likely, you will use your programming track for reading back CV data values.

To read back CV values using a programming track:

1. Be sure that only the locomotive you want to read back is on the programming track.
2. Press the **PROG** key to enter programming mode. The DCS51 will display one of the programming modes available.

Once the mode you want to use is on the screen you can go to step 3.

For example, to select Direct mode, stop pressing the **PROG** Key when the following screen appears:

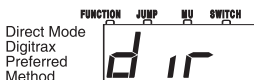

-
-
3. Press the **CV** Key and you will see **t** followed by the last CV number used by the DCS51. The **t** reminds you that you are in direct mode and the number displayed is the last CV used by the DCS51.



4. Enter the CV number you want to read back. If you want to read back the decoder's address, press the **LOCO** Key to toggle between Ad2 and Ad4. Stop pressing the **LOCO** Key when the address mode you want to read appears in the display.
5. Press the **CV-RD** key to read back the data value programmed into the decoder for the CV selected. Your screen will show something like this:



The numbers will flash for a few seconds as the command station reads back the data value in the decoder. The **d** means that you are looking at the CV's data value that is programmed into the decoder, in this case the CV value is 3.

6. You can now re-program the CV value or press the **EXIT** key to resume normal operations.

NOTE: OPS Mode Programming on most systems is write only. OPS mode Read back requires transponding decoders and transponding detectors on the layout in order to provide the two way communication required for read back.

16.7 Configuration Variable (CV) Programming Notes:

1. Check your decoder manufacturer's manual for factory settings, recommended CV value ranges and for instructions on resetting the CVs to factory settings.
2. It is good practice to record the changes you make to the CV values for each decoder/locomotive combination. This will allow you to profile each locomotive type for programming similar locomotives.
3. Resetting your decoder CV values to factory settings can eliminate some problems caused by inadvertently changing a CV value.

17.0 Functions

Most DCC decoders have function outputs that you can use to control lamps, LEDs, sound, smoke generators and other on/off devices installed in your locomotives. Most locomotives made today come with a head light and sometimes with a rear light, too. With DCC, these are controlled by the decoder's function outputs. You can also install additional DCC controlled lighting such as cab lights, Mars lights, ditch lights, rotating beacons and others on your locos. The addition of these functions can add to the fun and realism of your locomotives. *You must have the functions installed and connected to the appropriate decoder function leads in order to use the following keys.*

17.1 Controlling Functions F0-F9

To operate functions F0-F9 on your locomotive:

1. Select the loco you want to control on your throttle. On the throttle display, you will see the **FUNCTION Indicator Dot** illuminated to let you know that you can use the numeric keys to operate the functions.

*The **FUNC+10** and **FUNC+20** indicator lights should not be on when controlling functions 0 thru 9.*



2. Use the DCS51's numeric key pad to turn functions on and off. For example, to turn the head light on, press the **LAMP/0** key. Press the **LAMP/0** key again to turn it off.

17.1.1 Function 0 (F0) Headlights Forward and Reverse

Press the **LAMP/0** key to toggle function F0 between on and off. Each time the **LAMP/0** key is pressed while in function mode, Function 0, also called F0 will change from off to on or vice-versa. On locos with reversing head lamps and back up lamps, the head lamp or back up lamp in your loco will come on depending on the direction of travel of the loco. Function 0 is most often used to turn on/off the head light/back up light but can be set up for other functions as well (See your Decoder Manual for more information). It can be used as two functions.

17.1.2 Functions 1, 4, 5, 6, 7, 8 & 9

Press the number key on the numeric keypad that corresponds with the function number you want turn on/off. The function will toggle between on and off each time you press the number key.

The **BELL/1** Key is used for Function 1 (F1) and is labeled with a **BELL** icon to remind you that this is the preferred function key for bell operation.

17.1.3 Function 2 (F2) Momentary Operation

Press the **HORN/2** key on the numeric keypad. The **HORN/2** key operates Function 2 and is labeled with a whistle icon to remind you that this is the preferred function for whistle or horn operation. This key is set up as a “non-latching key” so that if a horn or whistle sound is installed in the loco, it will sound

for as long as the key is held down. This lets you vary the length of time that the horn or whistle blows, just like the prototype.

If you want Function 2 to remain on:

1. Press and hold the **HORN/2** key.
2. Press and hold the **EXIT** key.
3. Release the **HORN/2** key
4. Release the **EXIT** key.

17.1.4 Function 3 (F3) Standard or Momentary Operation

COUPLER/3 key operates Function 3 and is labeled with a **COUPLER** icon to remind you that this is the preferred function key for coupler operation.

The DCS51 treats Function 3 is a normal on/off function unless you set it up as a non-latching function like Function 2. This means that F3 can be used either as a normal function or to control a function that requires a momentary activation like some couplers.

To set up Function 3 as a non-latching function, set the DCS51's Option Switch 6 to closed as follows: (or follow instructions of section 28)

1. Press the **PROG** key. The last programming mode used by the DCS51 will be displayed.
2. Press the **SWITCH** key. The display shows the last switch used by the DCS51.
3. Use the numeric key pad to enter **6**. This tells the system that you want to change Option Switch 6, the OpSw that controls whether F3 is latching or non-latching.



Set OpSw 006 to t to make F3 non-latching.

4. Press the **c/-** key to make F3 non-latching. **OR** Press the **t/+** key to make F3 a normal latching on/off function.
5. Press the Exit key to complete the set up of F3 as a non-latching key. This will cause the **COUPLER/3** key to operate Function 3 as a non-latching function for this particular DCS51 and any attached Jump Throttles. Other throttles (including other DCS51s) in the system will not be affected.

17.1.5 MUTE Function Key (F8)

The DCS51 has a **MUTE** key that is an alternate to the F8 key that is commonly used to mute sound decoders. This key also indicates the current state of F8/MUTE for the addressed locomotive, and when the indicator light is on, F8 is ON and a sound decoder will be muted.

Note: Some Sound decoders may use functions other than F8 for mute. In the case of these decoders, the DCS51 MUTE key will operate F8.

17.1.6 Functions 10 through 19 (F10 - F19)

If the **FUNC+10** key is pressed and its indicator light is on, numeric keys 0 to 9 will control functions 10 through 19 respectively (number key+10). Pressing the **FUNC+10** key again will toggle off the led to show that 0-9 will now control functions F0 to F9.

17.1.7 Functions 20 through 28 (F20 - F28)

If the **FUNC+20** key is pressed and its indicator light is on then numeric keys 0 to 8 will control functions 20 through 28 respectively.(number key+20). Pressing the **FUNC+20** key again will toggle off the indicator light to show that 0-8 will now control functions F0 to F8.

17.2 Troubleshooting Function Operation

If the function you want to operate does not respond, check the following:

1. Is Track Status on? If not press the **POWER** key to turn it on.
2. Did you select the correct loco? If not, select it now.
3. Is the function you want to use installed in the loco? If not, you may need to install it. Most new locos have a head lamp/backup lamp installed, but most do not have any additional lights or sounds installed.
4. Change the position of the **Direction Control Lever** and see if the lamp comes on in the other direction. If the normal direction of travel feature in the decoder loco is set for the opposite of what you were expecting, you will see the head lamp operating in what you expected to be the reverse direction and vice versa for the back up lamp. See your Decoder Manual for information about how to change the Normal Direction of Travel (NDOT).

18.0 MU (Multiple Unit) Operations

It is not uncommon to see two, three or even four diesel locos pulling in consist at the front of a train. Sometimes, there is a locomotive added in the middle of the train or at the end of the train to give “helper service” to the head end locomotives. This is called Multiple Unit Operation or MU operation. With DCC, each locomotive is separately controlled. But in the case of MUing we would like to have more than one locomotive address controlled by a single throttle to simplify MU operation.

Your DCS51 uses universal consist to make MU operations simple and easy to do. This is the most flexible and realistic method of MUing available. You can add any locomotive to your MU, no matter what kind of DCC decoder is in your loco. You can even add an analog loco to your MU. You can add a locomotive to an MU in either orientation and in any physical location in the train. When you send commands to the MU you use the address of the TOP locomotive to control the entire MU and the command station handles the rest of the commands to the other locomotives in the MU. As the address you will use to control the consist is not necessarily the address of the lead or head end loco,

we use the term “TOP” for this special address. The TOP address can also be the train number.

You will not be able change the speed or direction of any individual loco that is part of an MU. Locomotive speed and direction for all locos in the MU are controlled by the TOP address.

18.1 Adding a Locomotive to an MU

To MU two addresses together with the DCS51:

1. Choose two locos you want to MU together. Place them on the track. Make sure that both locos that will be part of the MU are headed in the same physical direction. Select and run the first loco to determine which way it is headed. Then select the other loco and run it in the same physical direction.
2. Select the address you want to use to control the MU. This is called the TOP address. To do this, press **LOCO**, enter the address & press **LOCO** again. For this example, we will use loco address 09 as the TOP address and we will add address 23 to the MU.



3. Press the **MU** key. The TOP address will remain in the display and the **MU Indicator Dot** will begin blinking indicating that you are preparing to add to the MU.

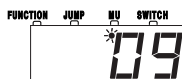

4. Use the numeric keypad to enter the loco address you want to add to the MU, in this case **23**.



5. Press the **t+** key. If the MU you just set up is valid, the display will revert to the TOP address. You are now ready to run your MU. To run your MU, just turn the **Throttle Knob** to set the speed and use the **Direction Control Lever** to change directions. Use the numeric key pad to control the functions on the MU'ed locos.



If you want to add more locos to the MU, repeat the procedure. To add locos to an MU you must add them to the TOP address. It's a good idea to keep an MU set up sheet like the following to help you remember which locos are MU'ed together:

MU Worksheet

Top Loco Address	
MUed Loco	
MUed Loco	
MUed Loco	
MUed Loco	
MUed Loco	

If your MU could not be set up you will see the following error message:

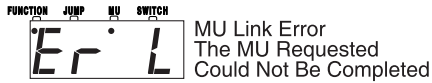

This happens when you try to link to an address that is already part of an MU or link an address that is under the control of another throttle. For example if you MUed address 14 to the top loco 23 and then tried to MU another address to 14 you would get this error. If you wanted to add another loco to the MU with 23 as the TOP address, the right way to do it is to add that loco to 23, not to another address in the MU.

18.2 Removing a Loco from an MU

To remove a loco address from an MU:

1. On the DCS51, select the loco address that you want to remove from the MU by pressing the **LOCO** key, entering the address and pressing **LOCO** again. In this example, the TOP address is 09 with address 23 MU'ed to it. We will remove address 23 from the MU. The display shows address 23 with the **FUNCTION** and **MU Indicator Dot** lit.

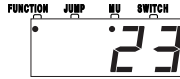

2. Press the **MU** Key. The **FUNCTION Indicator Dot** will go off and the **MU Indicator Dot** will blink indicating that you are MUing.



3. Press the **c/-** key to remove the loco address from the **MU**. The DCS51 will return to regular operation mode ready to run address 23 which you just removed from the **MU**.



18.3 MU of Mismatched Locomotives

If all the locomotives in the MU have performance characteristics that are closely matched, you can run all the MUed locomotives in 128 step mode. If the units are completely mismatched (for example if you are running two different brands of locos with noticeably different characteristics), then we recommend speed matching the locos by programming the decoder with either Simple 3 step or Advanced 28 step loadable speed tables (See your Digitrax Decoder Manual for more information on these features of your decoder).

18.4 Controlling Functions On MUed Locomotives

Even though an individual locomotive is part of an MU and you can't control its individual speed and direction, you can still control its function outputs independently as follows:

1. Select the loco that is part of an MU for which you wish to independently control functions. In this case we will select loco address 23 which we added to an MU with address 09 in the previous example. Press **LOCO**, enter the MUed loco's address, press **LOCO**. You'll see the loco address and the **FUNCTION** and **MU Indicator Dot** will be lit letting you know that you can control functions on this loco that is part of an MU.

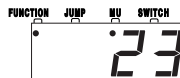

2. Use the numeric keypad to control the functions. The changes will take effect immediately if the locomotives are moving, otherwise changes will take effect when you reselect the TOP address on the throttle.
3. When you are finished turning functions on or off for the consisted loco, simply select the TOP address and resume running the MU.
4. Remember, you will not be able change the speed or direction of any individual loco that is part of an MU. Locomotive speed and direction for all locos in the MU are controlled by the TOP address.

Note: You can also control the functions of a MUed loco from a different throttle that is connected to LocoNet or with one of the Jump ports on the DCS51 (see Section 25.2 for setting up the Jump Ports), leaving the TOP locomotive selected on the main throttle of the DCS51. Function state changes will take effect immediately whether or not the loco is moving.

19.0 Stealing: When an Address Is Running on Another Throttle

Digitrax systems do not allow more than one user to select and run the same locomotive address unless the loco is “stolen” by the new user. When an address is receiving commands from more than one throttle, it may seem to be out of control.

Stealing is a safety interlock that prevents operators from automatically taking control of locos that are already selected and being run on another throttle. Occasionally you may need to override this interlock to gain control of a loco. This override is called stealing and will result in having a single loco address selected on two different throttles at the same time.

For example, if you are running a train on a particular loco address at 25% throttle and another operator is running the same loco address but sending a stop command you will see the train stop unexpectedly. From your perspective, the train is not behaving correctly so you would probably increase your throttle setting and the train would begin moving again. From the other operators perspective, the train is moving again so it is not responding to his/her commands. Since the other operator wants to stop the train, he or she is likely to send the command again since the train is now moving again. As you can see, having two engineers on the same train can give strange operations. For this reason, Digitrax interlocks locomotive selection so that you can't take control of a loco that is already selected on another throttle without “stealing” the address.

If you try to select a loco address that is already selected on another throttle in the system, the DCS51 will display “StLo” to let you know that if you want to select that loco you will have to “steal” it. A blinking StLo means Steal Loco?

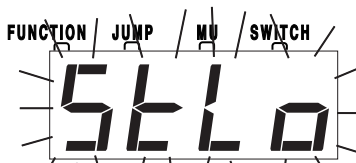

To steal an address:

1. Press the **LOCO** key, then enter the address for the loco and press **LOCO** to select the loco on your throttle. The display will first show the loco address then the following:



2. Press the **LOCO** key to accept control of the loco. Once a throttle has “stolen” a loco address, both throttles with the address selected will update speed and direction information for the loco address. This can result in strange locomotive behavior especially if one throttle is trying to stop the loco and the other is trying to speed it up at the same time.
3. When you have gained control of the stolen loco and are finished running it, release it from your throttle by setting the loco’s speed to 0 and pressing the **LOCO** key followed by the **EXIT** key.

This feature can be useful for training new operators or supervising engineers who insist on breaking the speed limit. The supervisor can “steal” a locomotive that is selected on a trainee’s throttle and be able to closely supervise that locomotive’s control, taking over when necessary. The supervisor can gain instant override control without having to physically “grab” the trainee’s throttle. This lets you have unskilled visitors participating and enjoying operations without too much anxiety for either party.

20.0 Releasing an Address From a Throttle

When you are finished running a locomotive address, release it from your throttle so that it is available for other throttles to select and run and so that your command station will have room to run other addresses.

To release an address from a throttle:

1. With the loco address selected on the throttle, use the **Throttle Knob** to set the locomotive’s speed to **STOP**.
2. Press the **LOCO** key to release the address from your throttle immediately. The address will begin to flash in the display.
3. Press the **EXIT** key to dispatch the address on the throttle and the locomotive will be released to the system and marked as a dispatched address. Your DCS51’s display will show Loco.
4. If you press the **LOCO** key again, the throttle will begin flashing the address you just released. You can re-select that address by pressing the **LOCO** Key or you can use the key pad to enter a new address and select it instead.

20.1 Dispatching Addresses or MUs

Dispatching is a special feature incorporated in the LocoNet “language” to meet the needs of operators that wish to enforce a strict discipline in how operators gain access to locomotives during an operating session. Dispatching also lets you run MUs with basic throttles that can’t set up their own MUs and run four digit addresses on basic throttles that only have two digit capability. It lets

you have newcomers run trains on the layout without giving them access to the entire operation.

When you dispatch a locomotive address or MU to your LocoNet system, you make it available to be acquired by another throttle. Only one address at a time can be marked as a dispatched address in the system. The dispatched loco address is acquired by the first throttle to request it by pressing the **ACQ** key to select it for use on that throttle. See the UT1, UT2 and BT2 throttle Manuals for complete dispatch operation instructions.

To dispatch a locomotive address using a the DCS51:

1. Press the **LOCO** key, enter the address you want to dispatch.
2. Press to the **EXIT** key to dispatch it to your LocoNet system, that's all there is to it!

The dispatched address can be a single locomotive address, either two digit or four digit, or an MU. The TOP locomotive in an MU can be dispatched to transfer control of the entire consist to another throttle.

21.0 The Full Message



If DCS51's display shows FuLL this means that it has reached the limit of 20 locomotive addresses that it can manage at one time. If you want to select additional addresses, you will need to release one or more loco addresses before you will be able to select other locomotives to run.

The DCS51 runs a “purging” routine that helps eliminate addresses that have not been used for a period of time to make slots available for running other addresses.

If you see this message while you are operating, you can release locos that you are no longer using by pressing the **LOCO** key, entering the address you want to release and then pressing the exit key.

22.0 DCS51 Error Messages

The DCS51 displays four types of error messages:

1) Short circuit shutdown occurs when the DCS51 detects a short circuit in the power district where it is connected to the layout. This can be a loco that has derailed or picked a switch or some other conductive material lying across the tracks. In this case you will see an “o” character walking across the display from left to right. Once the short is cleared, the DCS51 will resume normal operations. Note: If you turn the DCS51 off during a short circuit, you will need to press the Power key to regain control of the layout once power is applied again.

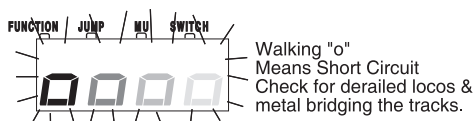

2) Current overload: A walking “c” occurs when the DCS51 has reached its 3 Amp current limit. In this case you should run fewer locomotives or add more boosters to increase the current limit of the total layout. See Section 25.3 for information on adding another DCS51 or see www.digitrax.com for information about adding boosters.

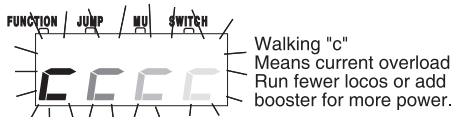

3) Input overvoltage: A walking “H” occurs when the input power to the DCS51 causes the internal voltage level to exceed about 16.9V DC. The DCS51 is designed to operate with DC input power only, off a 12V battery or with a PS314 power supply. These are configured to be below this upper voltage limit. **Note if you use an AC input supply such as a PS315 or PS515 you will likely see this error message, and the DCS51 will not allow track power to be turned on to protect equipment on the layout.**

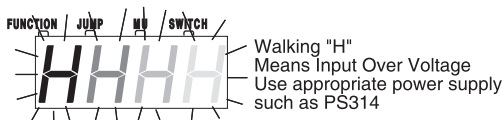

4) Loss of carrier: A walking “L” occurs when the DCS51 is configured as a booster and does not see another command station on the layout, or when LocoNet is disconnected from the unit in this condition. Check the LocoNet connections. Test LocoNet Cables with the LT1 tester. Be sure that a command station is connected to the layout.

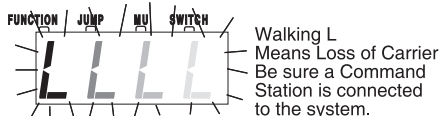

23.0 Decoder Speed Step Settings

Within the DCC format there are several ways decoders and command stations communicate speed step information. All of your decoders and your command station must be “speaking the same dialect of the DCC language” for everything to work smoothly. Digitrax DCS51 is set at the factory to send 128 speed step mode information because the 128 speed step format provides for the best speed control available. All Digitrax decoders are 128 speed step decoders. Some non-Digitrax decoders use other speed step formats and won’t respond to your DCS51 sending 128 speed step information.

If you have a non-Digitrax decoder that can’t run in 128 speed step mode, you can change the number of speed steps the DCS51 sends to that decoder so that you will be able to control the decoder. This is called **status editing** the decoder. When you status edit a decoder, the DCS51 will send a different format to that decoder without affecting the 128 speed step operation of the Digitrax and other 128 speed step decoders on the layout.

NOTE: Status editing does not reprogram anything in the decoder. It only changes the messages that are sent to the decoder by the command station.

23.1 Changing Speed Step Settings: Status Editing

To Change the Speed Step Settings for a Decoder:

1. Select the **LOCO** address you want to status edit.
2. Press the **STEPS** key. The display will show the choices available. You can scroll through the choices by pressing the **+** or **-** keys.





Reserved-Do Not Use



128 Speed Step Mode
With FX & Advanced Consisting

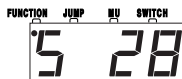

28 Speed Step Mode



Reserved-Do Not Use

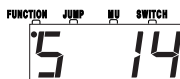

14 Speed Step Mode

3. Once the speed step setting you want to use is in the display, press the **EXIT** key to complete the speed step setting change and return to regular operating mode. Once this change is made, the DCS51 command station will send DCC commands to the edited decoder in the speed step setting you entered.

24.0 SWITCH Mode

Switch Mode is used for sending commands to accessory decoders and for changing Option Switches (OpSw) in your DCS51. The most common use of switch mode is for operating turnouts. The DCS51 remembers the current switch setting of switch numbers 1 to 512 during the session. For convenience it will allow switch numbers from 513 to 999 to also be selected and controlled on the layout. Switch commands may also be used for controlling Digitrax compatible signal units.

Digitrax uses the following convention for position information for turnouts:

- T** indicates that the switch is “thrown”
(for a turnout this means that the diverging route is set)
- C** indicates that the switch is “closed”
(for a turnout this means that the mainline route is set)

To change the position of a turnout:

This section assumes that you have already installed and programmed turnouts and turnout decoders on your layout.

1. Press the **SWITCH** Key.
2. The last switch address selected by your throttle is displayed followed by a

C or a **T**. The **SWITCH Indicator Dot** is lit to remind you that you are in Switch Mode.

NOTE: The “c” or “t” shown in the display may or may not match the physical position of the turnout selected. If the “c” or “t” is flashing, it means that the DCS51 has no information about the current position of the turnout. If the c or t is steady it means that the DCS51 remembers the last command sent by it to that turnout. This indication does not guarantee turnout position since, the turnout may have been moved by hand and the DCS51 has no way of determining actual turnout position.

The examples below show turnout address 087 first closed and then thrown

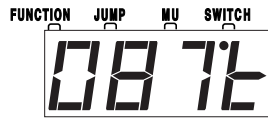
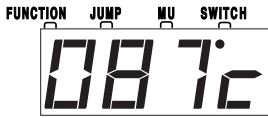

3. Use the numeric keypad to enter the turnout address for the turnout you want to change.
4. Press the **c/-** key to close the turnout or the **t/-** key to throw the turnout.
Note: While you are in SWITCH mode, the throttle knob and direction lever will continue to control the loco address running on the throttle.
5. When you have finished your SWITCH operations, press **EXIT** to return to normal operation mode.

24.1 Saving the last Switch states or settings for your current DCS51 session.

When you are ready to end your session on the layout, you can make the DCS51 remember the settings of switches 1 to 512 in non-volatile memory by pressing the **POWER** key to turn off the Track power *before* turning off the power input into the DCS51.

25.0 Adding Throttles: LocoNet & Jump Ports

Sooner or later you will probably want to have one or more other people run trains with you. This means you'll have to add more throttles to your DCS51. You can add any LocoNet throttle to your DCS51 or you can use one or two smooth DC power packs as Jump throttles.

25.1 Adding LocoNet Throttles To Your DCS51

Any LocoNet throttle can be used with your DCS51. Simply plug the LocoNet throttle into either LocoNet port on the back of your DCS51 or into any LocoNet or Throttle Jack anywhere on your LocoNet system. If you want to be able to plug in a throttle at a remote location, we recommend using a UP5 Universal Panel.

Your DCS51 can handle up to 20 LocoNet Throttles. If you need to run more than 20 throttles, you can move up to a Digitrax Command Station with additional capacity. You can continue to use your DCS51 as a throttle and booster with any command station on your Digitrax LocoNet system.

25.2 JUMP Ports: Using a Smooth DC Power Pack As an Additional Throttle

DCS51's Jump A & B ports can host two DC power packs as additional throttles. Begin with an operating DCS51 attached to your layout. Hook up one or two smooth DC power packs as shown in the following illustration. This configuration gives you three throttles to control three loco addresses.

1. The throttle knob and direction lever on your DCS51 is called the **Local Throttle**.
2. The throttle and direction controls on each of the smooth DC power packs you are using are called respectively, **Jump 1** and **Jump 2**.
3. Press the **JUMP** key to cycle from the **Local Throttle** to **Jump 1** to **Jump 2** and back to the **Local Throttle**. The **JUMP Indicator Dot** tells you which throttle functions are being addressed by the DCS51 keyboard.
No JUMP Indicator Dot - the Local Throttle
Steady JUMP Indicator Dot - Jump 1
Blinking JUMP Indicator Dot - Jump 2
4. The functions for each throttle are controlled by the DCS51's key pad when the **JUMP Indicator Light** for that throttle is displayed (see step 3).
5. To access function controls for each throttle, simply press the **JUMP** key to cycle among the three throttles.
6. When the throttle's **JUMP Indicator Dot** for which you want to control functions appears on the display, use the DCS51's keypad to change the functions. *The throttle knobs and direction controls for all three throttles will continue to control the loco selected on them while you are working with function controls on any of the three throttles.*

DCS51 Rear Panel Connections Diagram with Jump Ports

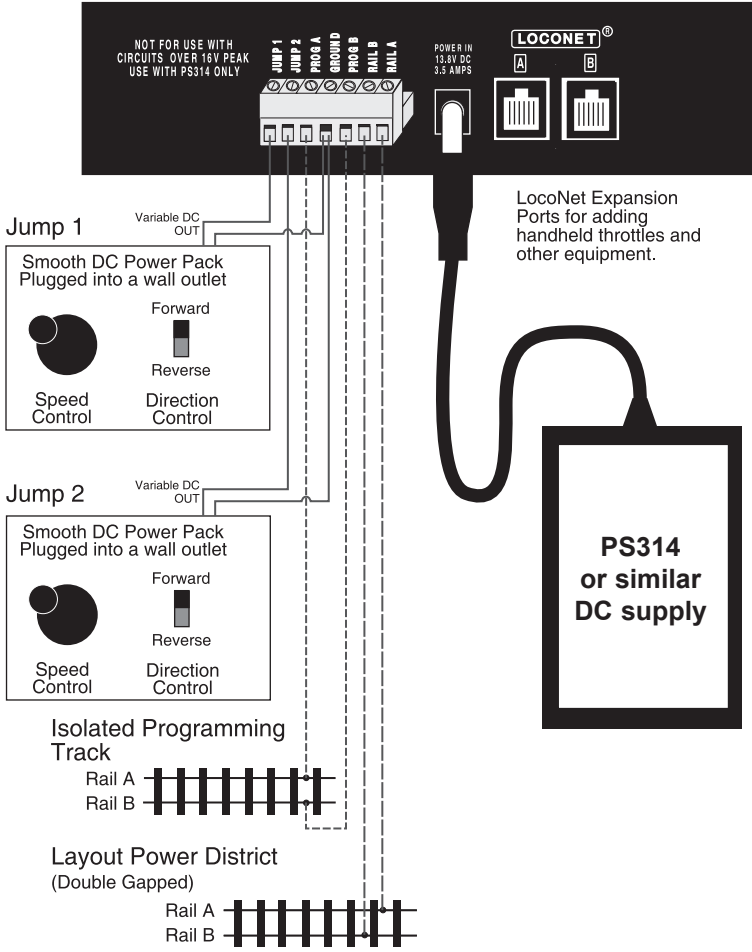

To view which addresses are being used by each throttle:

In the following example, locomotive address 3856 is selected on the **Local Throttle** and nothing is selected on either **Jump 1** or **Jump 2**.

1. The loco you are controlling on the DCS51's throttle knob is called the local throttle. The local throttle display looks something like this:

FUNCTION	JUMP	MU	SWITCH
•			
3856			

Function Indicator Dot Means that the numeric keys control functions for address 3856.

Locomotive Address 3856 Running on the DCS51's Local Throttle.

2. Press the **JUMP** key to view **Jump 1**:

Steady Jump Indicator Dot means that Jump 1 is in the display.



Loco in the display means that no loco is currently running on Jump 1.

3. Press the **JUMP** key again to view **Jump 2**:

Blinking Jump Indicator Dot means that Jump 2 is in the display.



Loco in the display means that no loco is currently running on Jump 2.

4. Press the **JUMP** key again to return to the **Local Throttle**:

Function Indicator Dot Means that the numeric keys control functions for address 3856.



Locomotive Address 3856 Running on the DCS51's Local Throttle.

To run a locomotive address on Jump 1:

1. Press the **JUMP** key until you have **JUMP 1** in the display, you'll see the **JUMP Indicator Dot** on steady and a screen like this if there is nothing selected on **JUMP 1**.

Steady Jump Indicator Dot means that Jump 1 is in the display.

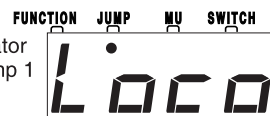

Loco in the display means that no loco is currently running on Jump 1.

Or, you'll see a screen similar to this if there is a locomotive address, in this case 481, selected on **JUMP 1**

Steady Jump Indicator Dot means Jump 1 is in the display.

Steady Function Indicator Dot means that the DCS51 keypad can be used to control functions on address 0481.

0481 in the display means Loco address 0481 is currently running on Jump 1.

A screenshot of the DCS51 display. At the top, there are four labels: 'FUNCTION', 'JUMP', 'MU', and 'SWITCH'. Below these labels is a digital display showing the number '0481' in a stylized font. A small dot is positioned above the 'JUMP' label, and another small dot is positioned above the 'FUNCTION' label. Arrows point from the text on the left to these two dots.

2. To select a loco on **JUMP 1** or to change the loco that is already there, press the **LOCO** key. The screen will begin flashing to let you know that the loco selection is pending. The display will now show the last loco that was selected on this throttle. It will look something like this:

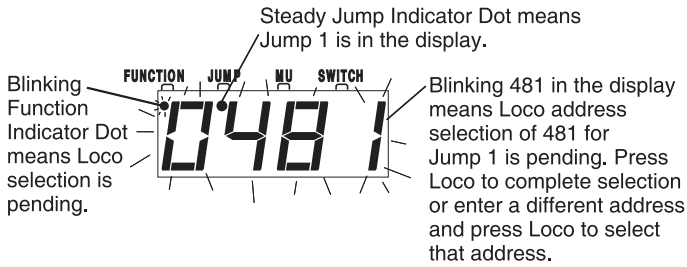

- Use the numeric keypad to enter the loco address you want to run, in this case locomotive **67**, on **JUMP 1** and press the **LOCO** key again to select it on **JUMP 1**. The display will be steady and you will be able to control the speed and direction of the loco you selected using the DC power pack attached to **JUMP 1**.

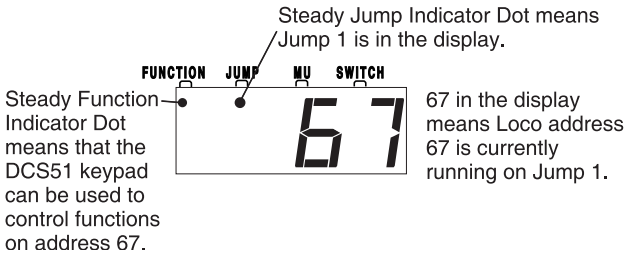

- When you have **JUMP 1** on the DCS51's display (**JUMP Indicator Dot** is steady), you can use the numeric keys to make changes to the function controls on the **JUMP 1** loco (turn on/off lights etc.). The smooth DC power pack being used as the **JUMP 1** throttle will continue to control speed and direction of the loco address selected on **JUMP 1**. The DCS51's **Throttle Knob** and **Direction Control Lever** will continue to control the speed and direction of the loco selected on the **Local Throttle** (loco 3856 from the previous section).

Note: You must have functions/lights installed and connected to the function leads of the decoder in order for the function keys to work. Many DCC ready locomotives have the headlight installed and the headlight can be turned on and off with the **LAMP/O** key. A sound board must be installed and connected in order to use the Whistle and Bell functions. A special coupler is required in order to use the Coupler function.

To run a locomotive address on Jump 2:

1. Press the **JUMP** key until you see the **JUMP 2** display on the DCS51. You will see the **JUMP Indicator Dot** flashing and either Loco or the address currently being run on **JUMP 2** in the display.

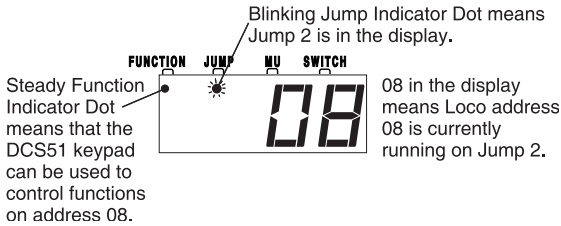

2. To select a different locomotive address, press the **LOCO** key, the display numbers will start to blink. Using the numeric keypad, enter the loco address you want to select and press the **LOCO** key again to complete the selection process. The display numbers will stop blinking.
3. When you have **JUMP 2** on the DCS51's display, you will control the locomotive's speed and direction on **JUMP 2** with the DC power pack and you can use the DCS51's numeric keys to make changes to the functions on the **JUMP 2** loco. The DCS51's throttle knob and direction lever will continue to control the speed and direction of the loco selected on the local throttle. The **JUMP 1** power pack will continue to control speed and direction of the loco address selected on the **Jump 1** throttle.

25.3 Adding Another DCS51 to your layout

Since each system, no matter how large, needs only one command station, you need only one DCS51 (or other Digitrax Command Station) performing this function. Any additional DCS51 must be converted to a booster by changing the Option Switch settings as described below. (Note, when using the DCS51 as a booster, the programming outputs are disabled.) The command station determines the total number of locomotive addresses your system can handle: Zephyr Xtra handles up to 20. Adding a booster does not change the number of addresses available to the command station, but you do gain additional power to run trains. When you add a DCS51 to an existing system you gain additional power (3.0A) for controlling power districts or reversing sections **AND** you gain an additional three throttles to control trains: the local throttle and the two jump port throttles.

To set up a DCS51 to run as a booster and throttle without command station capabilities:

1. Press the **PROG** key. The display shows the last programming mode used by the DCS51.
2. Press the **SWITCH** key. The display shows the last switch used by the DCS51. The **SWITCH Indicator Dot** will start blinking to indicate you are in Option Switch Mode.
3. Use the keypad to enter **2**. To let the DCS51 know you want to change **Option Switch 02**.

4. Press the **c/-** key. to let the DCS51 know that you want to change Option Switch 02 to c and make the DCS51 a booster and throttle only. The display will show 002c with “L”s walking from left to right through the display. This means that you have set the DCS51 to run as a booster and throttle causing a loss of carrier signal. This is normal.
5. Press the **EXIT** key. The display will show -br- followed by the last address used by the DCS51 with the walking Ls through the display.



6. Connect the DCS51 that is now running as a booster according to the wiring diagram shown on the following page.
7. As soon as the DCS51 is hooked up to the layout with a command station, it will resume normal operations.
8. To make the DCS51 autoreversing Press the **PROG** key, press the **SWITCH** key, Use the keypad to enter **3**, press the **c/-** Key and press the **EXIT** key. The DCS51 will now run as an auto reversing booster/throttle.

AutoReversing Note: DCS51 cannot be a command station AND be AutoReversing. To use DCS51 with AutoReversing, first disable the command station feature by setting Option Switch 02 to **c** (closed), then set Option Switch 3 to **c** (closed) to enable Auto Reversing.

Power Management Districts: To use a PM42 with DCS51, the **trip current** of the PM42 should be lowered from the default setting of 3 amps to 1.5 amps by setting the PM42 OPSW 09 to “c” and the **short circuit sensitivity setting** for each section should be set to “fastest” using the PM42 option switches. See the PM42 instruction manual for more information on customizing the Options on the PM42.

25.3.1 Assigning Throttle Identities

Each throttle in your system should be assigned a unique Throttle ID. To assign a throttle ID:

1. Using the throttle for which you want to set the ID, Press the **PROG** key.
2. Press **MU**. Display shows “id00”
3. Use the DCS51’s keypad to enter a unique number for the throttle. You may choose any number from 00 to 63. It is useful to label the back of the unit the the throttle ID assigned to it to prevent duplication of throttle IDs.
4. Press **EXIT** to return to normal operations.

Adding a Second DCS51 to Your Layout

DCS51 running as the system's command station
(With the original factory setting of Option Switch 02 set to "t")

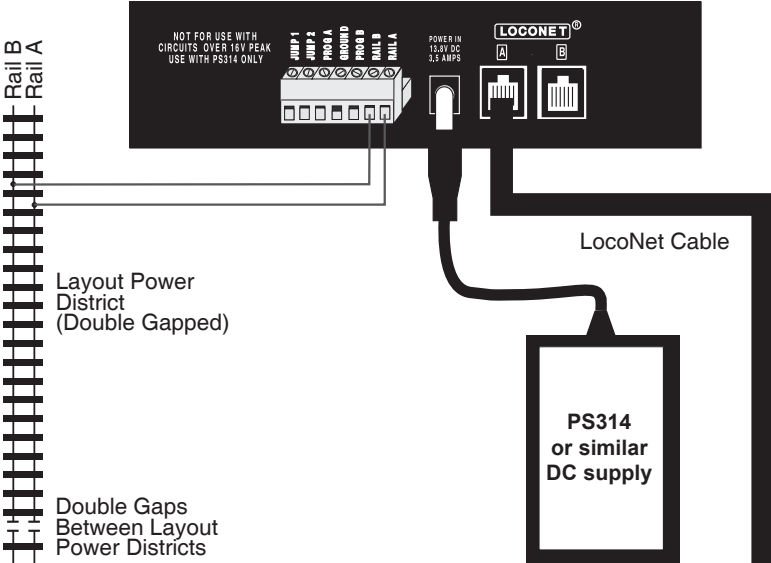

DCS51 running as a booster and throttle
(Option Switch 02 set to "c")

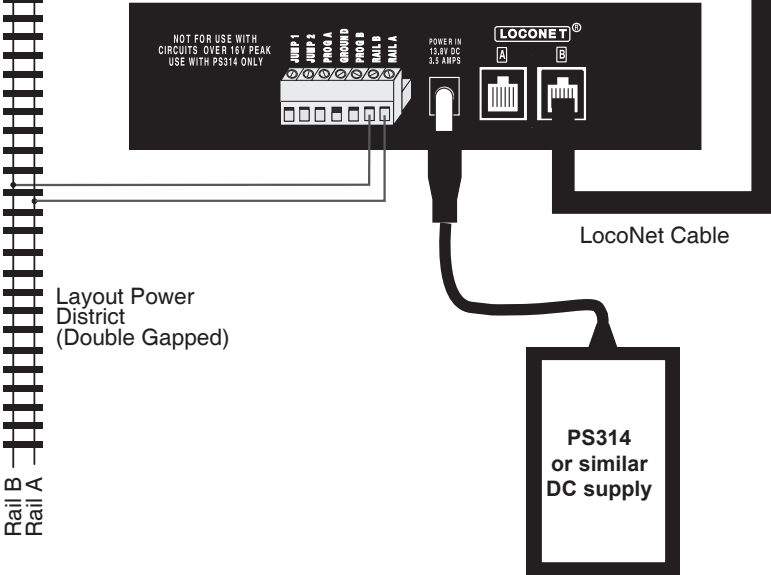

25.3.2 Making LocoNet Cables

LocoNet typically supports a total cable length of up to 2,000 feet with no two devices connected by more than 600 feet of cable. LocoNet wiring is totally free-form. We do not recommend looping LocoNet back on itself.

Making your own LocoNet Cables is simple and cost effective. LocoNet wiring consists of readily available wire and connectors. LocoNet uses flat 6 conductor wire and 6-pin RJ12 connectors. This kind of wiring is typically used for telephone wiring. Most Digitrax dealers can make up LocoNet cables for you. If you plan on wiring a large layout, you may want to invest in a good quality set of crimpers so you can make your own LocoNet cables. The LT1 tester that came with your Zephyr Xtra can be used to test LocoNet cables to be certain they are good before you install them on your layout. Many layout problems we see are related to LocoNet cables that were not built or crimped correctly.

LocoNet cables are wired pin 1 to pin 1. When you hold the plug with the tab up and look into the end of the connector you will see the wires listed below in the chart starting at the left side and moving to the right. (This is sometimes called a “reversing cable” in the telecommunications industry even though it really does not reverse).



We use the following wiring convention for all LocoNet cables/connections :

Pin #	Wire Color	Name
1	White	Rail Sync +
2	Black	Ground
3	Red	LocoNet
4	Green	LocoNet
5	Yellow	Ground
6	Blue	Rail Sync -

25.3.3 Testing LocoNet Cables with an LT1

1. Disconnect the wire harness from the LT1.
2. Plug one end of the LocoNet cable being tested into the LT1.
3. Connect the other end to the cable into one of the LocoNet ports on the back of the DCS51. Make sure the **TRACK STATUS Light** is lit.
4. All four LEDs on the LT1 will light if the cable is good. LEDs may not all be the same brightness, this is normal. NOTE: Only three LEDs will light if the **TRACK STATUS Light** is not lit.
5. If any of the LEDs fail to light, recrimp the plugs on the LocoNet cable and retest.

26.0 Clearing the System

Some users prefer to “dispatch” or release all addresses active in their system before shutting down. This can prevent unexpected results when you power up the layout again.

To release/dispatch addresses (this is optional):

1. Press the **LOCO** key.
2. Enter the loco address on the numeric keypad. The display will flash the **FUNCTION Indicator Dot** and the loco address. Press the **LOCO** key again.
3. Set the **Throttle Knob** to **STOP**.
4. Press the **EXIT** key.
5. Repeat for all locos/addresses used in your session.

To Shut Down the System:

1. Press the Power Key to turn track power off.
2. Unplug the PS314 from the wall.

27.0 Troubleshooting General

27.1 Nothing is responding

Is track power turned on? If the **TRACK STATUS Light** is not lit, press the **POWER Key** to turn on track power.

27.2 No Power or Intermittent Operation

The majority of intermittent operation problems can be traced to bad connections and poor or noisy wheel pickups on locomotives. The DCC digital packet communication strategy performs exceptionally well in a less than perfect environment, and will often mask bad connections until they are really impossible to work with! Clean the track and wheel pickups of your locomotives.

27.2.1 The Quarter Trick

If your track does not have adequate power supply to the locomotives, then the DCC signal won't get through either. Take a quarter or screwdriver blade and go around your layout creating electrical shorts by laying the quarter/screwdriver blade across both rails every 10 feet. Your DCS51 should shutdown when the short is present. You will see walking "o" on your display to indicate a short circuit shutdown. When the short is removed, the booster should return to normal operation. If the unit does not see a short or it does not return to normal operation after the short is removed, then you need to add more feeders.

27.2.2 The LT1 Tester

Check your LocoNet cables with the LT1 tester to be sure you don't have any cables that were made incorrectly. See Section 25.3.3.

27.3 Emergency Stop

If the layout starts to "get away" on you, press the **POWER Key** to stop everything on the layout.

27.4 Mechanical Drive Train Problems

Pay attention to the mechanical drive train and free movement of the locomotive wheel sets. This is especially important with inexpensive locomotives. Using Digitrax decoders with appropriate programming settings, you can achieve surprisingly good quality operation, if you carefully adjust the mechanisms for smooth running. See manufacturers instructions.

27.5 "Strange" Locomotive Lights

If you can't control the operation of the lights in your locomotive with the DCS51, be sure that the decoder is programmed to match the speed setting commands of your DCS51 command station. The factory setting for the DCS51 is advanced 28/128 speed step mode.

Your Digitrax decoder was shipped programmed to 28/128 speed step mode. You may have changed your decoder's programming when performing the decoder test procedure. In any case, if you are not able to turn the locomotives lights on and off, you will need to change CV 29 to a value of "06" to have proper light operation when using the DCS51 in its optimum 28/128 speed step

mode. Refer to Section 16.3 for programming instructions. Additional information about programming CV29 is available in your Digitrax Decoder Manual.

If you have a Digitrax Series 3 decoder and you can control the lights but not the motor, check for a motor short circuit. These decoders are designed to shut-down motor operation when a short is detected to prevent damage to the decoder.

27.6 Decoder Won't Respond

Did you select the locomotive's actual address? If you don't know the address of the locomotive on the track, you can read it back in programming mode or you can reprogram it to a new address. See Section 16.6

Is the loco on powered track?

Make sure the **Track Power Indicator** on the DCS51 is on, press the **POWER** key to turn on track power. See Section 7.2

Use the "Quarter Trick" to test for track power at several locations around the layout. If there is not track power, check your layout wiring. See Section 27.2.1

Can you select the loco on your throttle?

Is the loco in use by another throttle did the throttle display "StLo". If it did, then dispatch the loco from the other throttle.

If the loco is part of an MU, the **MU Indicator Dot** will light up when you select it. you can control the functions, but not speed and direction.

Do the settings in CV29, the configuration register, match the command station output? If your decoder is a 14 step decoder running on any Digitrax system using factory settings, status editing will be needed for that decoder.

Have you reset any CVs since the last time you ran the loco?

It is possible to set acceleration so high that it will take 10 minutes for the loco to start moving. Try resetting the CV values to their factory settings and then running the locomotive. Remember, Digitrax uses address 03 for the factory setting for all decoders. Check your decoder manual for factory settings and instructions on resetting the values.

Was the loco running normally just before it stopped?

Check to make sure the decoder has not heated up and gone into a thermal shutdown. If it is warm, remove the loco from the track, let it cool off and then see if it starts again. Also check for localized track problems.

Are there burn marks on the decoder? You'll need to send it in for repair!

If all else fails, reprogram the decoder address and reset CVs to factory original values. See your decoder manual for factory settings and reset instructions.

Does your throttle say "FuLL" ?

This means that the Zephyr Xtra system's capacity to handle operating locos is full. The DCS51 can run up to 20 addresses at the same time. This includes all decoder/locomotive addresses in use on the system, whether they are being run individually or as part of an MU. If you have the "FuLL" message, be sure that all locos that are not running are released from throttles. If you run into this

problem often, you should consider a command station with more capacity.

27.7 I'm totally lost!

If your DCS51 display isn't showing you what you expect based on the manual, press the **EXIT** key to return to normal operating mode. Then try the throttle task again. If you think you might have made an inadvertent change to one of the factory settings in either the decoder or the command station, try resetting everything to the factory settings and try the task again. See your decoder instructions for resetting the factory settings of the decoder. See Section 28 for resetting the DCS51 factory settings.

27.8 DCS51 Shutdown

If the DCS51 shuts down briefly and then comes back on again, it is probably being run too close to its pre-set current limit of 3.0 Amps. In this case it may clip or mutilate some outgoing packets of information to keep the track current within acceptable limits. To solve this problem, reduce the track current load by running fewer locomotives or setting up additional power districts and adding more boosters to provide more power for the layout. See Section 25.3.

28.0 DCS51 Option Switch Setup

The DCS51 has several system operation options that you can use to customize your operations. The DCS51 is set up at the factory to run right "out of the box." Most customers never have any need to change these options.

Changing DCS51 Option Switches

1. See the DCS51 Option Switch Table that follows to decide which option switches you want to change.
2. Press the **PROG** key. The display shows the last decoder programming mode used by the DCS51.
3. Press the **SWITCH** key. The display shows the last switch used by the DCS51 and its commanded position.
4. Use the numeric keypad to enter the number of the Option Switch you want to change.
5. Press the **cl-** or **t+** key to set the OpSw to the setting desired.
6. Press **EXIT** when finished. The DCS51 display will show **-cS-** to indicate that you are running in command station mode or **-br-** to indicate that you are running as a booster/throttle only.

The following table shows the effects of setting various option switches. The factory settings for all DCS51 option switches are noted in the right column.

To reset the DCS51 Option Switches to factory settings:

If you change option switches and experience unexpected results, just set OpSw 39 to "c" (closed) to reset the unit to the original factory settings.

DCS51 Option Switch Table		
Option Switch #	Effect on System operation when “closed”	Factory Setting
OpSw 01	c=1 Jump Port t=2 Jump Ports	t
OpSw 02	c=DCS51 runs as booster/throttle with no command station capability.	t
OpSw 03	c=DCS51’s booster is auto reversing	t
OpSw 05	c=No change allowed for Throttle ID, Vmax or Brake Rate	c
OpSw 06	c=Function 3 is non-latching	t
OpSw 07	c=Blast Mode programming allows DCS51 to program sound decoders that require more power than is available in Service Mode programming.	t
OpSw 10	t=Recall Depth 2, c=Recall Depth 4	t
OpSw 11	c=Recall Depth 8	t
OpSw 13	c=Loco address purge time extended from 200 seconds to 600 seconds.	t
OpSw 14	c=Loco address purge time is disabled	t
OpSw 15	c=Purge will force a loco to Stop or 0 speed	t
OpSw 17	c=Automatic advanced decoder assisted consists are disabled	c
OpSw 18	c=Extend the DCS51 booster short circuit shutdown time from 1/8th to 1/2 second	t
OpSw 20	c=Disables address 00 or analog stretching for conventional locomotives.	t
OpSw 21	c=OPSW21-23 set the global system default type for “NEW” loco selections. SW21/22/23 set as follows:	t
OpSw 22	t-t-t=3: 128 step mode t-t-c=7: 128 step FX mode	t
OpSw 23	c-t-t=2: 14 step mode c-c-t=0: 28 step mode t-c-c=5:	t
OpSw 27	c=Disable normal switch commands, a.k.a the “Bushby bit.” Allows attached PC to perform switch control logic	t
OpSw 28	c=Disable DS54 interrogate commands at power on	t
OpSw 33	c=Allows track power to restore to prior state at power on	c
OpSw 34	c=Allows track to power up to run state, if was run prior to power on	c
OpSw 39*	c=Return DCS51 to factory option switch settings	t
OpSw 43	c=Disable LocoNet update of command station’s track status	t
OpSw 45	c=Disable reply for switch state request	t

NOTE: Do not change any option switches not listed in the table.

29.0 LocoNet: The Digitrax Difference



29.1 System Architecture

System architecture is the biggest difference among DCC systems. System architecture is the way the components of a DCC system communicate among themselves. Digitrax LocoNet is a Peer to Peer local area network (LAN) designed specifically for model railroad operation. LocoNet wiring is cost effective,

flexible and expandable to accommodate almost anything you want to do with your railroad today and in the future.

29.2 System Expansion

The following diagram shows some of the expansion possibilities available with LocoNet. LocoNet sets Zephyr Xtra apart from other entry level DCC sets because it's expandable. With Digitrax LocoNet your DCC journey starts at the Main Station with your first "starter" set. From there, it's up to you. You can add:

- Mobile decoders for your locomotives
- Function decoders for more lights and other functions on your locos.
- More boosters to give you more power to let you run more trains,
- More throttles for more operators,
- Different types of throttles,
- More throttle jacks for convenient walk around operation,
- Infrared or radio capability for more freedom for operators,
- Accessory decoders for turnout and accessory control,
- Detection,
- Transponding,
- Signaling,
- A personal computer to automate operations or for dispatching,
- Use your cellphone as a throttle,
- Automatic reversing with a booster or power manager,
- And the list goes on and on.

With LocoNet, you customize your layout to run the way you want it to run! There is a lot of information available to help you along the way. The Digitrax web site, www.digitrax.com, contains a wealth of information on all of our products. Digitrax users maintain a chat list that can be very helpful, too.

30.0 FCC Information

Radio or TV Interference: (this information is MANDATED by the FCC)

This equipment has been tested and found to comply with the limits for a Class B digital device, pursuant to part 15 of the FCC rules. These limits are designed to provide reasonable protection against harmful interference in a residential environment. This equipment generates, uses and can radiate radio frequency energy and, if not installed and used in accordance with the instruction manual, may cause harmful interference to radio communications. However, there is no guarantee that interference will not occur in a particular installation. If this equipment does cause harmful interference to radio or television reception, which can be determined by turning the equipment off and on, the user is encouraged to try to correct the interference by one or more of the following measures:

- Reorient or relocate the receiving antenna.
- Increase the separation between the equipment and the receiver.
- Connect the equipment into an outlet on a circuit different from that to which the receiver is connected.
- Consult the dealer or an experienced radio/TV technician for help.

Note that any modifications to the equipment not expressly approved by Digitrax voids the user's authority to operate under and be in compliance with CFR 47 rules, as administered by the Federal Communication Commission. Digitrax believes any conscientiously installed equipment following guidelines in this manual would be unlikely to experience RFI problems.

For Canadian Users:

“This digital apparatus does not exceed the Class B limits for Radio noise emission from digital apparatus set out in the Radio Interference Regulation or the Canadian Department of Communications.”

Le present appareil numerique n emet pas de bruits radio-electriques depassant les limites applicables aux appareils numeriques de la classe B prescrites dans le Reglement sur le brouillage radioelectrique edicte par le ministere des Communications du Canada.

31.0 Digitrax 'No Worries' Warranty & Repair

Digitrax gives a one year "No Worries" Warranty against manufacturing defects and accidental customer damage on all Digitrax products. That's it! A simple, straightforward warranty with no tricky language!



For complete warranty and repair details see www.digitrax.com. Please contact Digitrax tech support at (850) 872 9890 before sending anything to us for service so that we can try and resolve the problem by phone or e-mail. Except as expressly stated in the full warranty statement, there are no warranties, express or implied, including but not limited to any warranties of merchantability or fitness for a particular purpose.

All warranties on Digitrax products are limited to refund of purchase price or repair or replacement of Digitrax products at the sole discretion of Digitrax. In the event that Digitrax products are not installed or used in accordance with the manufacturer's specifications, any and all warranties either expressed or implied are void. Except to the extent expressly stated in this section, there are no warranties, express or implied, including but not limited to any warranties of merchantability or fitness for a particular purpose.

Digitrax, Inc. reserves the right to make changes in design and specifications, and/or to make additions or improvements in its products without imposing any obligations upon itself to install these changes, additions or improvements on products previously manufactured.

Specifications

Size: 7" length x 5" width x 3" high
18 cm x 12.5 cm x 7.4 cm

Weight: 12.5 ounces
354 grams

Caution: This electrical product is not a toy. Not recommended for unsupervised use by children under 14 years of age.

For protection against fire, electrical shock and other hazards, this unit must be operated from a 12V DC battery or isolated DC SAFETY EXTRA LOW VOLTAGE SUPPLY (SELV) with appropriate overload protection.

Electrical Rating:

Maximum Input: 3 Amps, 16.8 Volts DC, 42 VA continuous.

DO NOT exceed 16.5V DC input.

Digitrax recommends the use of a 12V DC battery or a dedicated PS314 power supply or equivalent for use with the DCS51. PS314 output is rated at 13.8V DC and allows up to 3Amps to enable correct operation of the unit.

A 2mm power connector is needed to connect a 12V DC battery or SELV UL Class 2 rated DC power supply that meets the stated requirements.

Output (to track): DCC digital waveform of approximately 0.5V less than input DC voltage, which meets recommendations for most HO and N scale locomotives with DCC decoders installed.

Patents & Intellectual Property:

As of the date of this writing Digitrax, Inc. owns the rights to the following patents which may cover some or all of the products covered in this brochure: US 6,275,739, 6,536,716, 6,533,223, 6,367,742 B1, 6,533,224. Additional patent applications are pending. LocoNet is maintained as trade secret information.

Trademarks: As of the date of this writing Digitrax, Inc. owns the following trademarks which may cover some or all of the products covered in this manual: Digitrax, The Digitrax Train Logos, LocoNet, Super Empire Builder, Super Chief, Transponding, Zephyr Xtra Jump and others. Additional trademark registrations are pending. Digitrax trademarks may not be used in any form without prior written consent of Digitrax, Inc.

Copyrights: Copyright © Digitrax, Inc. world wide rights reserved. Contents of these pages are not to be reproduced or reprinted in any form without the express written consent of Digitrax, Inc.

Digitrax, Inc. is not responsible for unintentional errors or omissions in this document.

Notes



Index

128 speed step mode 19
28/128 speed step mode 52

A

acceleration & deceleration 18, 21, 53
Ad2-Two digit address 24
Ad4-Four digit address 24
Adding a Locomotive To An MU 33
Adding Another DCS51 47
Adding Throttles 43
Address 00 Running Analog Locos 7, 15
Address 03 (Factory Default) 8, 15, 22
analog locomotive (without a decoder) 7, 14, 15
Assigning Throttle Identities 48
AutoReversing 48

B

BELL/1 Key 17, 30
booster 47
BRAKE 9, 18
BRAKE Indicator Light 9, 20, 21
brake rate 21

C

c/- Key 31, 35, 38, 42, 48, 51
Changing Speed Step Settings-Status Edit 40
Changing the Decoder Address 24
clear all addresses 38
Clearing the System 51
closed 41
Controlling Functions F0-F9 30
Controlling Functions On MUed Locomotives 35
cS-DCS51 is a Command Station 13
current limit 39
current overload 39
CV Configuration Variable 22, 29
CV Key 25
CV-RD Read Back CVs 24, 28
CV-WR Write CVs 25

D

d nA error message 28

d nd error message 28
d nr error message 28
DC Power Pack-To control DCC Locos 43
DCC decoder address 15
DCC Decoder or Address Basics 15
DCS51 Front Panel Controls And Indicators 9
DCS51 Shutdown 54
deceleration/acceleration 21
Decoder factory settings (reset) 29, 53
Decoder Won't Respond 53
dir-Direct Mode Programming 24, 25, 26, 28
Direction Control Lever 9, 18
Direction/Brake 7
Dispatching Addresses or MUs 37
Display-DCS51 Main Display 11

E

Emergency Stop 20, 21, 52
Error Messages-Electrical 39
Error Messages-MUing 34
Error Messages-Programming 28
EXIT Key 20, 54

F

FCC Information 57
Forward/Reverse 7, 18
FuLL Message-20 Address Limit Reached 38, 53
FUNC+10 Key 30, 32
FUNC+20 Key 30, 32
Function 0 (F0) Headlights 30
Function 2 (F2) Momentary 30
Function 3 (F3) Standard or Momentary 31
Function Indicator Dot 11, 30
Functions 30
Functions 1, 4, 5, 6, 7, 8 & 9 30
Functions 10 to 19 (F10 - F19) 32
Functions 20 to 28 (F20 - F28) 32

H

Hooking Up Your Zephyr 12
HORN/2 Key 30

I

I'm totally lost! 54
Input overvoltage 39

J

JUMP Indicator Dot 11, 43
JUMP key 43
Jump Port 12, 43

L

LAMP/0 Key 17, 30
LOCO key 7, 8, 14
Locomotive Direction Control 18
Locomotive Speed Control 20
LocoNet 40, 43, 56
LocoNet Cables, Making & Testing 50
LocoNet Ports A & B 12
Loss of carrier 40
LT1 Tester 52

M

Mechanical Drive Train Problems 52
MU Indicator Dot 11, 33, 35, 53
MU Multiple Unit Operations 32
MU of Mismatched Locomotives 35
MU set up sheet 33
Mute Key (F8) 31

N

No Power or Intermittent Operation 52
Normal Direction of Travel (NDOT) 32
Nothing is responding 52

O

OPS Mode Programming-How To 27
OPS-Operations Mode Programming 22, 24, 25, 26, 27, 29
Option Switches 41, 54

P

PAGE-Paged Mode Programming 24, 26
PHYS Physical Register Programming 24, 26
PM42 Power Management 48
Power In Jack 5, 12, 13

POWER key 6, 13
Power Management Districts 48
Preparing Your Layout 9
Preparing Your Locomotives 9
PROG A & B 12, 22
PROG key 24
Programming Configuration Variables 25
Programming Display 26
Programming Track 22
Programming Your Decoder 22
PS314 Power supply 5, 13, 18

Q

Quarter Trick 52, 53
Quick Start Guide 4

R

Rail A & B 5, 12, 13
Reading Back CV Values 28
Rear Panel Connections 12, 44
RECALL Key 17
Releasing An Address 37
Removing A Loco From An MU 35
Reset the DCS51 Option Switches to factory settings 54
resetting CVs to factory settings 29
Resuming Operation 18
Reverse 18
Run A DCC Equipped Locomotive 8, 15
run a locomotive address on Jump 1 45
run a locomotive address on Jump 2 47
Run A Locomotive Without a DCC Decoder 14
Running your DCC Locomotive 16

S

Saving the last Switch states or settings for your current DCS51 session. 42
select a loco 45
Service Mode Programming 22
Short circuit 39
Shutting Down the System 18
Specifications 59
Speed Limit 20
status editing 19, 40

Stealing An Address-StLo Message 36
STOP 7, 18, 20
SWITCH Indicator Dot 11, 41, 47, 51
SWITCH key 41, 54
SWITCH Mode 41
System Architecture 56
System Expansion 56

T

t/+ 31, 33, 42, 54
thermal shutdown of decoder 53
Throttle Knob 9
thrown 41
TOP address 33
Track Power 6, 53
TRACK STATUS Light 6, 13, 14, 15
Troubleshooting Basic Operation 19
Troubleshooting Function Operation 32
Troubleshooting General 52
Troubleshooting Locomotive Lighting 19,
52
Troubleshooting Stopping 21
turnout 41

V

view which addresses are being used by
each throttle 44

W

Warranty & Repair 58
Whistle/2 17
write only 29



Zephyr Xtra

Command Station, Booster and Throttle

Go Beyond DCC With



Complete Train Control

Main Station

Starter Sets
LocoNet®
Power Supplies



Your Digitrax LocoNet® Starter Set is just the beginning of an exciting trip! Pick the one that's right for you!



LocoNet®
The Digitrax Difference

Locomotive Shops

Mobile Decoders
Function Decoders
SoundFX™ Decoders

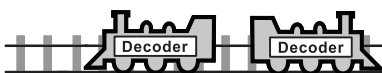

More Fun For Everyone

Add More Boosters, Advanced & Simple Throttles, Power Supplies, Universal Panels, IR and/or Radio for more trains and operators.

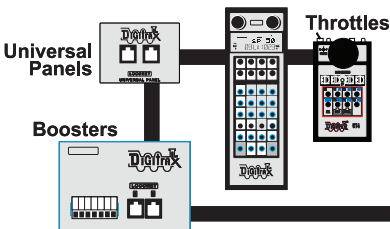

Maintenance Of Way

Make your layout more fun & simpler to operate!

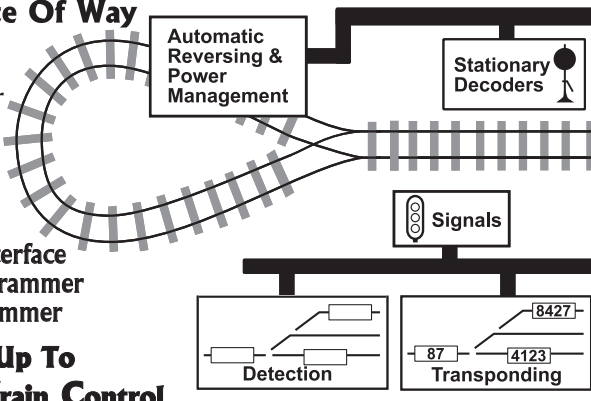

Computer Controls

Computer Interface
Decoder Programmer
Sound Programmer

It All Adds Up To Complete Train Control



Made in U.S.A.

2443 Transmitter Rd
Panama City, FL 32404
www.digitrax.com

T 850-872-9890
F 850-872-9557

Zephyr Xtra



6 52667 01047 4

307-0001-0000