



DZ146IN

Fits Many N and HO
Locomotives

.386" x .559" x .137"
9.8mm x 14.2mm x 3.48mm

N Scale
Mobile Decoder
1.0 Amp/1.5 Amps Peak
4 FX³ Functions, 0.5 Amp
with 6 Pin NEM 651 type plug

Features:

- FX³ Function outputs for prototypical lighting effects and on/off control:
Constant Brightness Lighting with directional or independent control.
Optimized selectable LED or incandescent lamp operation
Realistic Effects like Ditch lights, Mars lights, strobes, and many more
Configurable Pulse Function available on all function outputs.
FX³ & Standard Function Qualifiers operate functions based on direction, Fo on or off, direction and Fo, and whether loco is moving.
Function Mapping for custom function setup.
Master Light Switch turns off all lights & functions with one keystroke.
Advanced Consist Function Controls.
- **Digitrax LocoMotion® System**-Your locomotives look like the real thing. The Digitrax LocoMotion System makes them run like the real thing too!
Scaleable Speed Stabilization (Back EMF) with simple setup & 256 level resolution.
Torque Compensation.
128 Speed Step operation (14 or 28 steps can also be used).
Momentum with acceleration and deceleration.
Normal Direction of Travel is user selectable.
Switching Speed feature for easier and faster access to yard speeds.
3 Step Speed Tables set start, mid and max voltage for custom control.
28 Step Speed Tables with 256 level resolution for precise control.
- Program CVs using any Digitrax Compatible Control system without having to buy any extra equipment.
- 2 Digit and 4 Digit Addressing.
- Basic, Advanced & UniVersal Consisting.
- SuperSonic motor drive for silent operation.
- Direct mode programming.
- Decoder Reset CV with or without speed table reset.
- Transponder Equipped ready for transponding on your Layout.
- Motor Isolation Protection helps prevent damage to your decoder.
- Automatic Analog Mode Conversion when running on DC layout.
- Decoder Lock for individual programming of multiple decoders in one loco.
- Digitrax "No Worries" Warranty.

Parts List

1 DZ146IN Mobile Decoder

1 Instruction Sheet

Installation Information

See the Digitrax Decoder Manual for complete decoder test procedures, installation instructions, programming and technical information. Digitrax manuals and instructions are updated periodically. Please visit www.digitrax.com for the latest versions, technical updates and additional locomotive-specific installation instructions. **CAUTION: Programming and layout track must not exceed 16V when using this decoder.**

Installation Instructions

1. Carefully remove the locomotive's shell from the frame. Notice the orientation of the shell to the frame so that you can reinstall correctly.
2. Remove the 6 pin analog shorting plug and in its place insert the DZ146IN decoder with the correct pin-1 orientation. The DZ146IN has 6 pins that insert directly into the 6 pin socket (NEM 651 type) on the locomotive's PCB. The DZ146IN's small size allows the decoder to be easily installed in a variety of European locomotives. For the Kato EMD Class 66 example, the DZ146IN should be inserted in the socket as shown in Figure 2.

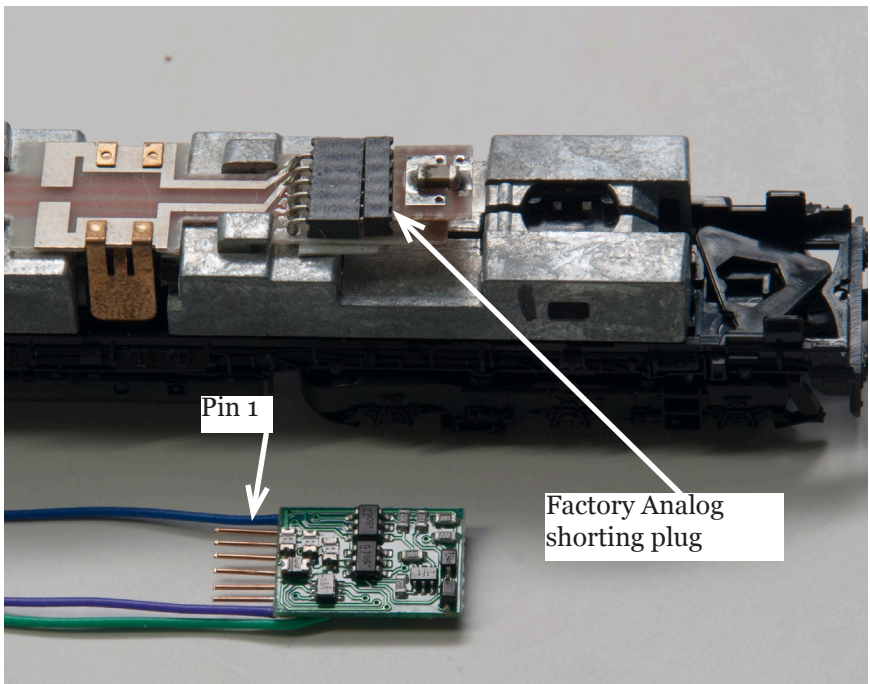

Figure 1: Kato factory N-EMD class 66

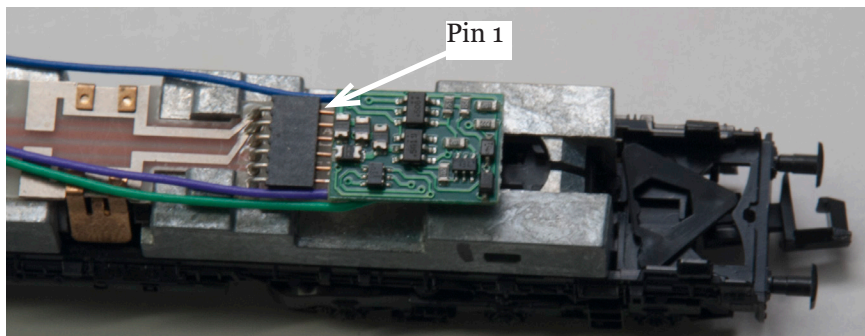
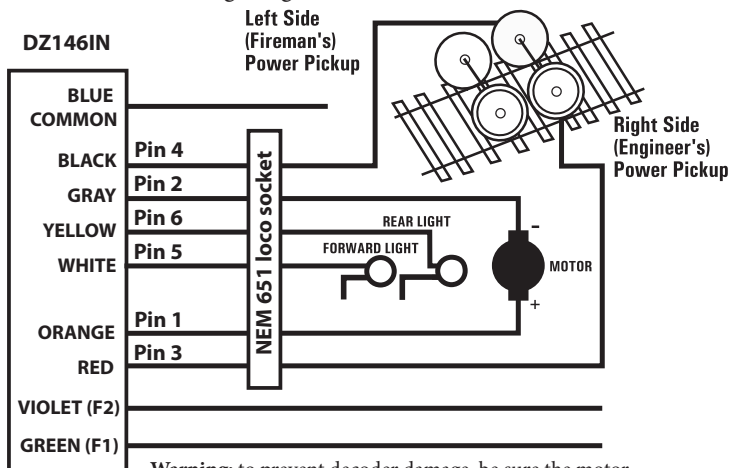

Figure 2: Kato N-EMD class 66 with DZ146IN installed

3. The Green (F1), Violet (F2), and Blue(Common) wires can be used to install additional functions or tucked out of the way for future use.
4. Test the locomotive on some track with a DCC system to verify motor and lights work in both directions.
5. Reinstall the locomotive's shell.

For other N scale locomotives be sure to identify the correct pin 1 location of the locomotive socket from the manufacturer's instructions.

Figure 3: DZ146IN Wiring Diagram



Warning: to prevent decoder damage, be sure the motor brushes are properly isolated before applying power.

Installation Notes

1. Do not exceed the decoder's 500mA total function output rating.
2. The additional lamps should be hooked up using the Blue/+Common wire for optimal Digitrax transponding operation.
3. To use a function output with an inductive (coil) type load, see the Digitrax Decoder Manual for more information to avoid damage to the decoder.
4. See the Digitrax Decoder Manual for full details of wiring 12-16V lamps, 1.5V lamps, and LEDs. Lamps that draw more than 80 mA when running require a 22 ohm 1/4 watt resistor in series with the directional light function lead to protect the decoder.
5. Some locomotives employ filter capacitors for RFI suppression in the locomotive wiring. These may cause problems with Supersonic decoders and non-decoder analog operation on DCC. This capacitor should be removed for safe operation.

Customizing Your Decoder

Your Digitrax decoder is ready to run and will operate using address 03 with no additional programming. For a more prototypical railroading experience, your decoder can be customized for your specific locomotive by programming some of the Configuration Variables, or CVs, available. See the Digitrax Decoder Manual or the Digitrax web site for more information.

Changing the Decoder Address

The first CV most people change is the decoder address. This allows you to independently control each loco with a unique address. Digitrax decoders are shipped with CV01 (AD2), the two digit address, set to 03. Following is a brief description of how to change the decoder address with a Digitrax DT4XX series throttle. See your Starter Set Manual for complete programming instructions.

1. Place the loco on the **programming track not to exceed 16V**. Go into Program Mode on your system. On DT4XX throttle press **PROG**.
2. Choose AD2 for 2 digit addressing or AD4 for 4 digit addressing.
3. Choose the address you want to set up for the decoder.
4. Complete address programming by pressing **ENTER**.

Note: CV29 must also be programmed to enable 4 digit addressing, this is done automatically by the DT4XX throttles. See your Digitrax Decoder Manual or the Digitrax Toolbox App for how to set up CV29.

Digitrax LocoMotion® System

Your locomotives look like the real thing, now you can make them run like the real thing, too. Digitrax decoders incorporate torque compensation for smooth as silk operation. You can also program CVs that control momentum, 3 step and 128 step speed tables, switching speed, normal direction of travel, scalable speed stabilization and more to take full advantage of the Digitrax LocoMotion System.

Momentum-CV03 & CV04

Momentum is part of the LocoMotion System. Acceleration is controlled by CV03 and deceleration by CV04. Both come from the factory set to 000. A range of 000 to 031 is available for both accel and decel. Try CV03:003 and CV04:000 as a starting point for experimenting with momentum.

Speed Tables-How the Loco Responds to the Throttle

With Digitrax LocoMotion, there are two types of speed tables: 3 Step Tables and High Resolution 28 Step Tables. Please see your Decoder Manual for a discussion of the 28 Step Tables. The 3 Step Tables are set up by programming 3 CVs: Start Voltage (CV02), Mid point Voltage (CV06) and Max Voltage (CV05). These values are set at 000 at the factory. All have a range of values from 000 to 255. We recommend the following CV values as a starting point for experimenting with speed tables.

| Loco Type | V Start CV02 | V Mid CV06 | V Max CV05 |
|---|-------------------------|-----------------------|-----------------------|
| Switcher Concentrated low speed. Limited top speed | 002 | 038 | 064 |
| Road Switcher Prototypical top speed w/evenly distributed curve from 0 to top speed | 002 | 048 | 098 |
| Mainline Loco Quick increase to cruising speed then levels off to prototypical top speed. | 002 | 128 | 154 |

Other LocoMotion® Features: Switching Speed, Normal Direction of Travel & Scalable Speed Stabilization (Back EMF) Features

Switching speed is controlled by CV54. The factory setting is 000 for OFF. To turn on the switching speed feature, program CV54 to a value of 001. When this feature is on, use F6 to activate and deactivate switching speed. With the feature on the throttle's target speed is effectively reduced by about 50% and the effects of accel and decel programmed into the decoder are reduced by 1/4. This is useful for yard switching operations.

Normal Direction of Travel is controlled by CV29. See your decoder manual or the Digitrax Toolbox App for additional information on the settings for CV29.

The intensity, or droop, of **Scaleable Speed Stabilization (Back EMF)** is controlled by CV57. The factory setting for this feature is 006 which is suitable for most locos. You can adjust this value in the range of 000 for OFF to 015 for the maximum effect. Consult your Digitrax Decoder Manual for info about CVs 55 & 56 and their effects on scaleable speed stabilization.

SuperSonic Silent Operation and Torque Compensation

The factory settings in the decoder provide silent, smooth operation of your locomotive under most conditions. For more information about these settings, please see the Digitrax Decoder Manual or our website.

Digitrax Transponding CV61

Digitrax Transponding is controlled by CV61. The initial factory set value is 000 for OFF. To turn on transponding, program CV61 to a value of 002. This allows you to use Digitrax transponding to keep track of your rolling stock. When transponding is enabled, the front light of the locomotive will flicker slightly to indicate transponding signal is being communicated. For optimal transponding operation, we recommend that you hook up the forward and rear lights as shown above.

Decoder Reset CV08

Decoder reset lets you reset all CV values to the initial factory settings. To reset all CV values, program CV08 to a value of 008. You also have the option of resetting all the CV values except the 28 speed step tables and CV60 selected sound scheme. To do this program CV08 to a value of 009.

Function Outputs on the DZ146IN

The DZ146IN is set up at the factory to control four function outputs.

The DZ146IN is configured to control the forward and reverse lights on the locomotive through the integrated pins using Function 0 (FoF-forward and FoR-reverse) for directional lighting. Functions F1(Green) and F2 (Violet) are part of the harness for easy hookup. The wire colors indicated are the standard color code used in the industry. These colors are important if you plan to use function remapping.

All four function outputs can be easily set up with Digitrax FX³ lighting effects or as standard on/off functions with the following operational qualifiers:

1. Forward or Reverse direction of travel, or
2. Whether Fo is on or off, or
3. Both direction of travel and whether Fo is on or off, or
4. Whether the locomotive is stopped or moving.

Master Light Switch

Each of the four function outputs can be programmed to turn on and off with the Fo ON/OFF key on your throttle, creating a Master Light Switch. The CV values for creating this effect are listed in the Digitrax Decoder Manual in the section: *Setting up FX & FX3 Effects On Function Outputs*.

Warranty & Repair

Digitrax gives a one year “No Worries” Warranty against manufacturing defects and accidental customer damage on all Digitrax command stations, boosters, throttles, decoders, power supplies and layout control devices.

That’s it! A simple, straightforward warranty with no tricky language!
Visit www.digitrax.com for complete warranty details and instructions for returning items for repair.

Please return warranty items directly to Digitrax - DO NOT return items to place of purchase.



DZ146IN
Fits Many N and HO Locomotives

Go Beyond DCC With Digitrax® Complete Train Control

Main Station

Starter Sets
LocoNet®
Power Supplies



Locomotive Shops

Mobile Decoders
Function Decoders
SoundFX™ Decoders

More Fun For Everyone

Add More Boosters,
Advanced & Simple Throttles,
Power Supplies,
Universal Panels,
IR and/or Radio
for more trains and operators.

Maintenance Of Way

Make your
layout more
fun & simpler
to operate!

Computer Controls

Computer Interface
Decoder Programmer
Sound Programmer

It All Adds Up To Complete Train Control

Your Digitrax LocoNet® Starter Set is just the beginning of an exciting trip! Pick the one that's right for you!



LocoNet®
The Digitrax
Difference

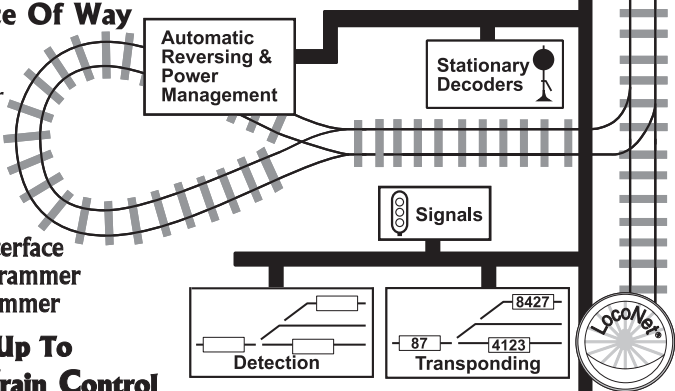
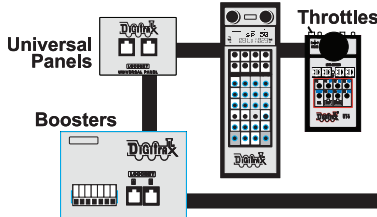
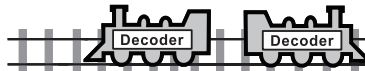

Made in the USA

Part 15, Class B
RFI Compliant



2443 Transmitter Road
Panama City, FL 32404

www.digitrax.com

Contact: www.digitrax.com/contact

Support: techsupport@digitrax.com

Repair: repair@digitrax.com

DZ146IN

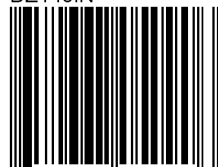

6 52667 05090 6